

INSTITUTO TECNOLÓGICO DE COSTA RICA

VICERRECTORÍA DE INVESTIGACIÓN Y EXTENSIÓN

DIRECCIÓN DE PROYECTOS

ESCUELA DE INGENIERÍA FORESTAL

CENTRO DE INVESTIGACIÓN EN INNOVACIÓN FORESTAL

INFORME FINAL DE PROYECTO DE INVESTIGACIÓN

**MEJORAMIENTO EN LA EFICIENCIA DEL PROCESO DE SECADO CONVENCIONAL Y
HOMOGENIZACIÓN EN EL COLOR DE LA ALBURA Y EL DURAMEN EN MADERA DE
TECA (*Tectona grandis* L.)
Código: 5401-1401-1030**

(DOCUMENTO I)

INVESTIGADORES:

*Ing. Alexander Berrocal J. Dr.
Ing. Roger Moya R. Dr.
Lic. María Rodríguez S.
Ing. Freddy Muñoz A. Dr.*

Mayo, 2016

ÍNDICE GENERAL

Pág.

1. Artículo 1. Decrease in kiln drying time of juvenile <i>Tectona grandis</i> L. wood using drying rate.	3
2. Artículo 2. Kiln Drying of plantation-grown <i>Tectona grandis</i> wood with daily-controlled drying rate schedules: Effects on the final moisture content, drying time, wood colour and drying defects.	19
3. Artículo 3. Surface chemical and color characterization of juvenile <i>Tectona grandis</i> wood subjected to steam-drying treatments.	35
4. Artículo 4. Efecto de tratamientos de secado-vaporizado sobre el contenido de humedad, tasa de secado, color y defectos de secado en madera juvenil de <i>Tectona grandis</i> proveniente de plantaciones de rápido crecimiento.	49

Resumen General

Different drying schedules were investigated to decrease drying time of *Tectona grandis* L. wood from juvenile plantations, using the drying rate (*DR*) to reduce time. The *DR* value was 20% per day during the first stages and by the time the wood reached 30% of moisture content (*MC*), the *DR* remained in 8% per day until the end of drying. The initial moisture content (*MC_i*) ranged between 92 and 115%, *MC_i* was affected by grain pattern and heartwood percentage. The final moisture content (*MC_f*) differed in 2.0% in relation to the *MC* targeted for this study. Drying time can be reduced from 140 hours to 105 hours, maintaining *DR* conditions and saving 33% of energy consumption. *DR* is affected by moisture content and drying time and this behavior can be modeled mathematically by the equation $Y = a \cdot t + b$. In these relations, the factors with greatest influence were dry-bulb temperature and wet-bulb depression. Both relations show an inflexion point in the relation *DR-MC*, 80% in fast drying schedule and 40% in slow drying schedule. This *MC* indicates the point where the *DR* must be changed.

1. Artículo 1. Decrease in kiln drying time of juvenile *Tectona grandis* L. wood using drying rate.

**DECREASE IN KILN DRYING TIME OF JUVENILE *Tectona grandis* L. WOOD
USING DRYING RATE**

Alexander Berrocal

Escuela de Ingeniería Forestal, Instituto Tecnológico de Costa Rica

Apartado 159-7050, Cartago, Costa Rica

E-mail: aberrocal@itcr.ac.cr

María Rodríguez-Solis

Escuela de Ingeniería Forestal, Instituto Tecnológico de Costa Rica

Apartado 159-7050, Cartago, Costa Rica

E-mail: maria.rodriguez@itcr.ac.cr

Róger Moya†*

Escuela de Ingeniería Forestal, Instituto Tecnológico de Costa Rica

Apartado 159-7050, Cartago, Costa Rica

E-mail: rmoya@itcr.ac.cr

Freddy Muñoz

Escuela de Ingeniería Forestal, Instituto Tecnológico de Costa Rica

Apartado 159-7050, Cartago, Costa Rica

E-mail: fmunoz@itcr.ac.cr

Diego Pérez

Life Forestry Costa Rica S.A.

Curridabat, San José

Apartado postal 733-2250 (Tres Rios, Cartago)

(Received March 2015)

* Corresponding author

DECREASE IN KILN DRYING TIME OF JUVENILE *Tectona grandis* L. WOOD USING DRYING RATE.

ABSTRACT

Different drying schedules were investigated to decrease drying time of *Tectona grandis* L. wood from juvenile plantations, using the drying rate (*DR*) to reduce time. The *DR* value was 20% per day during the first stages and by the time the wood reached 30% of moisture content (*MC*), the *DR* remained in 8% per day until the end of drying. The initial moisture content (*MC_i*) ranged between 92 and 115%, *MC_i* was affected by grain pattern and heartwood percentage. The final moisture content (*MC_f*) differed in 2.0% in relation to the *MC* targeted for this study. Drying time can be reduced from 140 hours to 105 hours, maintaining *DR* conditions and saving 33% of energy consumption. *DR* is affected by moisture content and drying time and this behavior can be modeled mathematically by the equation $Y = a*t + b$. In these relations, the factors with greatest influence were dry-bulb temperature and wet-bulb depression. Both relations show an inflexion point in the relation *DR-MC*, 80% in fast drying schedule and 40% in slow drying schedule. This *MC* indicates the point where the *DR* must be changed.

Key words: kiln drying, energy consumption, Dry-bulb temperature, wet-bulb temperature, wood drying

INTRODUCTION

Tectona grandis is the mostly used species in tropical climates for commercial reforestation (Moya *et al.*, 2014). However, a disadvantage for competing with other tropical species is the prolonged drying time, even under high percentage of juvenile wood (Moya *et al.*, 2014). In relation to this, Moya *et al.* (2013) found that *T. grandis* is one of the species with higher drying time among tropical species and Salas y Moya (2014) reported a drying period of 9 to 11 days, a higher period than the species *Pinus radiata*, for example, able to dry in 4 days (Ananías *et al.*, 2012).

Formerly, Hsueh and Jing-Sheng (1997) studied 3 different drying methods in *T. grandis* and found less time and energy consumption in high temperature drying compared to kiln drying, without mentioning drying times. Basri and Wahyudi (2013) compared lumber quality of young *T. grandis* trees (less than 10 years) with lumber from trees over 45 years of age, founding a lower quality in dry lumber from young trees, thus recommending the use of temperatures higher than 50 °C for this kind of lumber. On the contrary, Pleschberger *et al.* (2013) studied also the effects of using high temperatures in drying schedules for *T. grandis* and contradicts this result. The authors found that high temperatures have few effects in this specific fracture of energy.

Research on drying process for *T. grandis* are limited, in some cases are contradictory and few of them are aimed to improve drying times. Therefore, the objective of this study was to decrease the drying time of *Tectona grandis*

wood from juvenile fast-growing plantations using drying rate and controlling temperature changes on drying schedules.

BACKGROUND

Drying is an important stage in the wood manufacturing process as it contributes to the dimensional stability, workability, finish and adhesive wettability, among other wood properties (Gu *et al.* 2004). Multiple studies are aimed to improve drying aspects but few of them are related to reduce drying time (Tenorio *et al.*, 2015). Wood drying varies for each species and subjected to the drying schedule (Carlsson and Arfvidsson, 2007). Different methods are used in wood drying, such as kiln, vacuum, dehumidifier, and solar dry. Kiln drying using conventional ovens and high investment and operational costs, qualified labor, and complex humidity-control systems are commonly used in most countries (Simpson and Baah, 1989).

Kiln drying has the advantage of controlling the drying rate (Oltean *et al.* 2009, Murphy and Schindler, 2011). Drying rate (moisture loss over a period of time), is a variable that could positively influence quality and time of drying. This parameter is affected by the inherent characteristics of wood (Denig *et al.* 2000, Klitzke and Batista 2010, Tenorio *et al.*, 2015), the drying chamber (Espinoza *et al.* 2007) and drying conditions (temperatures, relative humidity and wind velocity) (Denig *et al.* 2000).

Drying rate (*DR*) is used to improve drying time, especially in species from temperate climates (Denig *et al.* 2000). But research on drying rate on juvenile wood from tropical fast-grown plantations has been limited to a few species. Recently, Tenorio *et al.* (2015) studied the effect of drying time and moisture content variations upon *DR* in several tropical species to improve drying times.

MATERIAL AND METHODS

Plantation and sampling characteristics

Wood samples were taken from a second thinning intervention in a plantation of *Tectona grandis* of 11 years old, with 3 x 3 m spacing (1100 trees ha⁻¹). Stand density was 475 trees ha⁻¹, with an average diameter at breast high (DBH) of 23 cm and 14 m height. The plantation is located in north region of Costa Rica, property of *Life Forestry Costa Rica S.A.* The area is located within the tropical moist forest, with a mean annual temperature of 27 °C and 32 °C, precipitation of 3500 mm. Sampled trees correspond to fresh thinned trees, from which 7 to 9 logs (1.25m) per tree were cut until reaching a minimum diameter of 13 cm, for an average diameter of 17 cm from all logs.

Grain pattern

The grain pattern used for the present study was commonly implemented in Costa Rica for timber from forest plantations to produce 25-mm-thick boards (Fig. 1). This sawing pattern is detailed in Moya (2007). A total of 1200 edged 25-mm-thick boards were obtained.

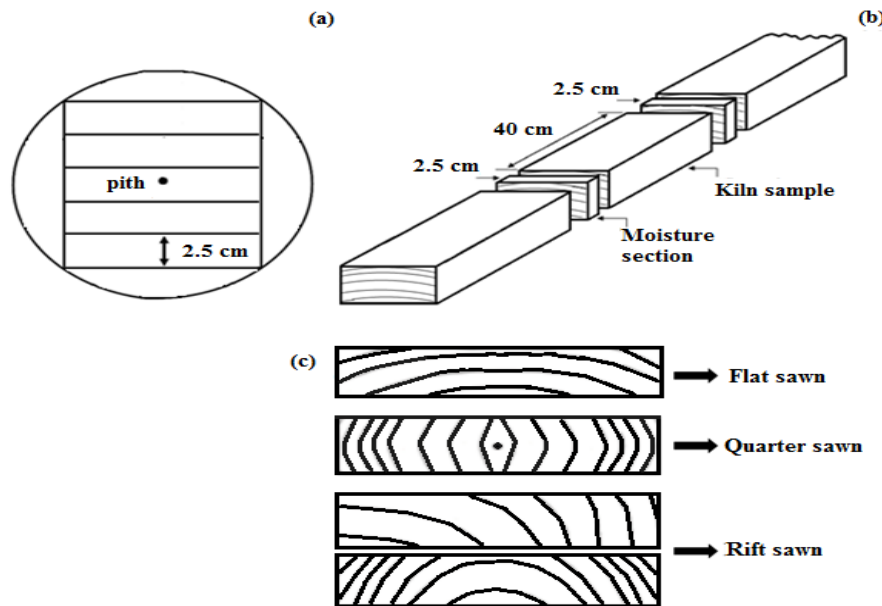

Fig. 1. Sawing pattern used in each log (a), sample obtained for determining moisture content (b) and cutting types on the wooden boards (c).

Drying schedules

Three different drying schedules were used. The first schedule named “Drying schedule 1” (*DS-1*) was recommended by Sydney *et al.* (1998) for *T. grandis*, specifically the “H” schedule and previously used in other research (Moya *et al.*, 2013; Salas y Moya, 2014). This drying schedule aimed to establish the drying rate (*DR*) over 20% day⁻¹ during the first 3 days and then maintain the drying rate in 8% day⁻¹.

The second drying schedule (*DS-2*) derives from the previous schedule and the only difference is the establishment of 3 more stages and more constant changes in temperature and equilibrium moisture content to increase *DR* to 30% day⁻¹ during the first 3 days and then to 10% day⁻¹, thereby decrease drying time.

The third schedule (*DS-3*) aimed to reduce drying time and consisted on more stages but with higher dry-bulb temperatures than the other drying schedules (Table 1).

Table 1. Different drying schedules for wood of *Tectona grandis* tested on kiln drying

Step	Drying schedule 1 (DS-1)			Drying schedule 2 (DS-2)			Drying schedule 3 (DS-3)		
	DBT/WBT °C	EMC %	MC %	DBT/WBT °C	EMC %	MC %	DBT/WBT °C	EMC %	MC %
Heating	55/-	-	60	55/-	-	60	55/-	-	60
	58/54	14.0	60	58/54	14.0	60	58/54	14.0	60
Drying	60/56	13.8	30	60/56	13.8	60	58/54	14.0	-
	60/52	10.0	25	60/54	12.5	50	60/54	12.5	50
	70/58	7.7	20	60/52	10.0	40	60/52	10.0	40
	70/55	6.4	20	65/55	8.5	35	65/55	8.5	35
	75/50	3.7	10	70/58	7.7	25	70/58	7.7	30
				75/58	6.4	25	75/60	6.4	25
				75/55	5.2	15	80/60	5.0	20
				75/50	3.7	12	80/55	3.7	12
Equalization	75/70	11.0	-	75/70	11.0	12	80/74	11.0	12
Conditioning	75/68	11.5	-	75/68	11.5	-	80/75	11.5	-
Cooling	35/28	11.5	-	35/-	-	-	35/-	-	-

Legend: *TBS* : Dry-bulb temperature; *EMC* : equilibrium moisture content; *MC* : lumber moisture content *Schedule H (Adjust) from Sidney *et al.* 1988; *DS*: Drying Schedule.

All drying schedules tested were performed using a pilot dryer brand NARDI® (San Bonifacio, Italia), with 2 m³ capacity and using an electrical power source to heat the resistance inside the chamber. Green lumber was stacked in packages of 10 boards wide and 30 pieces height, obtaining 300 pieces per drying. Cross-sectional pieces of 2.5x2.5 cm were used to separate the wooden boards. Each drying schedule was performed in duplicates; therefore, 6 different drying executions were performed.

Moisture content control

Moisture content (*MC*) was determined before and after drying, *MC* was measured in all boards submitted to drying. In addition, the *MC* decrease was monitored using control samples. For the *MC* before drying, named "initial *MC*" (*MC_i*), a cross section of 2.5 cm thick was extracted from each board. *MC_i* was determined in this small sample according to ASTM-4442-07 standard (ASTM 2012). For final *MC* (*MC_f*) a cross section of 2.5 cm thick was extracted from each board after drying and *MC* was measured using the ASTM-4442-07 standard (ASTM 2012).

A total of six samples were selected for *MC* decrease measurements during the drying process. Kiln samples of 400 mm long were obtained from boards in the middle of the lumber packages as representative samples of the load (Simpson, 1991). These samples were placed at different heights of the wood stocked in the drying chamber. Before beginning with drying, the *MC_i* was determined by measuring it from the 2.5 cm transversal section

obtained from each board (Fig. 1b). *MC* was determined using standard ASTM D-4442-07 procedures (ASTM 2012). Next, the *MC* determined was allocated to six representative samples. Kiln samples were weighed on a daily basis for obtaining the drying rate. Then, the schedule (steps) was applied according to *MC* of six representative samples.

Heartwood proportion and grain pattern in each boards

The effect of heartwood and grain pattern on the *MC_i* and *MC_f* was determined using another sample of 5 mm thick, obtained when the sample for *MC* determination was extracted. This 5 mm sample was scanned using an EPSON XP 201 scanner. Then, with the software ImageJ 1.X (Schneider *et al.*, 2012) heartwood area was determined in order to obtain heartwood proportion in relation to the cross area of the wooden piece. The same sample was used to identify and catalogue the cutting type on the cross section for each sample: flat sawn, quarter sawn and rift sawn (Fig. 1c).

Energy input used during drying

Energy used on each drying schedule was measured in kilowatts per hour (kWh) and was determined by measuring the electric power consumption. A Schneider Electric model PM200 digital gauge was used to record electricity consumption and was measured every time the samples were weighed. The electricity input was defined as the total electrical energy used for drying.

Data analysis

The variation coefficient and the average values for *MC_i* and *MC_f* of each drying type were determined and the frequency distribution of data was plotted to show variation of the two *MC* parameters on each drying. Then, an analysis of variance (ANOVA) was carried out to establish differences between the different drying types.

Similarly, values for *MC_i* and *MC_f* were calculated on the control samples (used to control the drying process). *DR* was calculated using *MC_i* and *MC_f* values of the six control samples and the drying time (Equation 1). Grain pattern effect on the *MC_i* and *MC_f* was obtained from the variance analysis and from the difference between the means and Tukey's multiple rate. Heartwood percentage effect on the different drying types was determined using linear regression analysis ($y = m\beta + b + error$, β : heartwood percentage). For *MC* variation with time, exponential models were used (Equation 2).

$$Drying\ rate\ (\% / hours) = \frac{(initial\ MC(\%) - final\ MC(\%))}{drying\ time\ (hours)} \quad (1)$$

$$MC = a * e^{-b*t} \quad (2)$$

$$DR = at^2 + bt + c \quad (3)$$

$$DR = at^3 + bt^2 + ct + d \quad (4)$$

Where: MC = moisture content (%) and t = drying time (h), DR =Drying rate (% day⁻¹); t = drying time (h); a, b, c and d: coefficients of model

Finally, DR was determined on a daily basis. For this, equation 1 was used but with MC_i and MC_f values corresponding to the MC values that were obtained during each drying day. Then, the relation between DR regarding drying time (h) and MC of wood was established. The relationship between DR and drying time was modeled using a polygonal trend line of grade 2 for $DS-2$ and of grade 3 for $DS-1$ and $DS-3$ (equations 3 and 4, respectively). The best-fit models were chosen based on their determination coefficient (R^2).

For the relation DR and MC , a linear regression model was adjusted. During the 3 drying schedules it was observed that data presented two trends, therefore they were separated and adjusted to the regression model corresponding to each set of data. Once data was adjusted to the models, inflexion points or trend changes were determined between DR 's variation and the MC for each drying schedule. Software *SAS* was used for the statistical analysis.

RESULTS

Initial and final moisture content and effects of the cutting pattern and heartwood presence

MC_i of lumber used in $DS-1$ and $DS-3$ was higher than 100%, whereas lumber used in $DS-2$ presented a MC_i of 92%. For $DS-1$, dried lumber showed a MC_f of 7.4% and for the remaining drying schedules the MC_f in dried lumber varied from 10.7% to 12.7% (Table 2). The variation (CV) for MC_f in dried lumber in the different drying schedules was lower than 9%.

Table 2. Initial and final moisture content, drying time and average drying rate for the three evaluated drying schedules for juvenile wood of *T. grandis*.

Drying Schedule	Initial MC (%)	Final MC (%)	Heartwood (%)	Drying Time (h)	Average Drying Rate (% day ⁻¹)
<i>DS-1</i>	115 (14.3) A	7.37 (8.8) A	65.5	110	41.8
<i>DS-2</i>	92 (19.4) B	10.74 (8.0) B	67.3	140	28.3
<i>DS-3</i>	106 (18.7) C	12.74 (8.6) C	82.7	105	49.4

Note: Letters indicate statistical significances at 99%. The values in parenthesis represent the coefficient of variation.
Legend: MC : Moisture Content.

MC_i frequency distribution (%) for wood shows a normal distribution and was similar in the 3 drying types (Fig. 2). Lumber on $DS-1$ showed the highest MC_i (125%), whereas lumber on $DS-2$ had the lowest MC_i (95%). The MC_f for dried lumber with $DS-2$ and $DS-3$ showed a more flattened distribution, compared to values obtained with dried lumber with $DS-1$, which denotes greater variability of data (Fig. 2a).

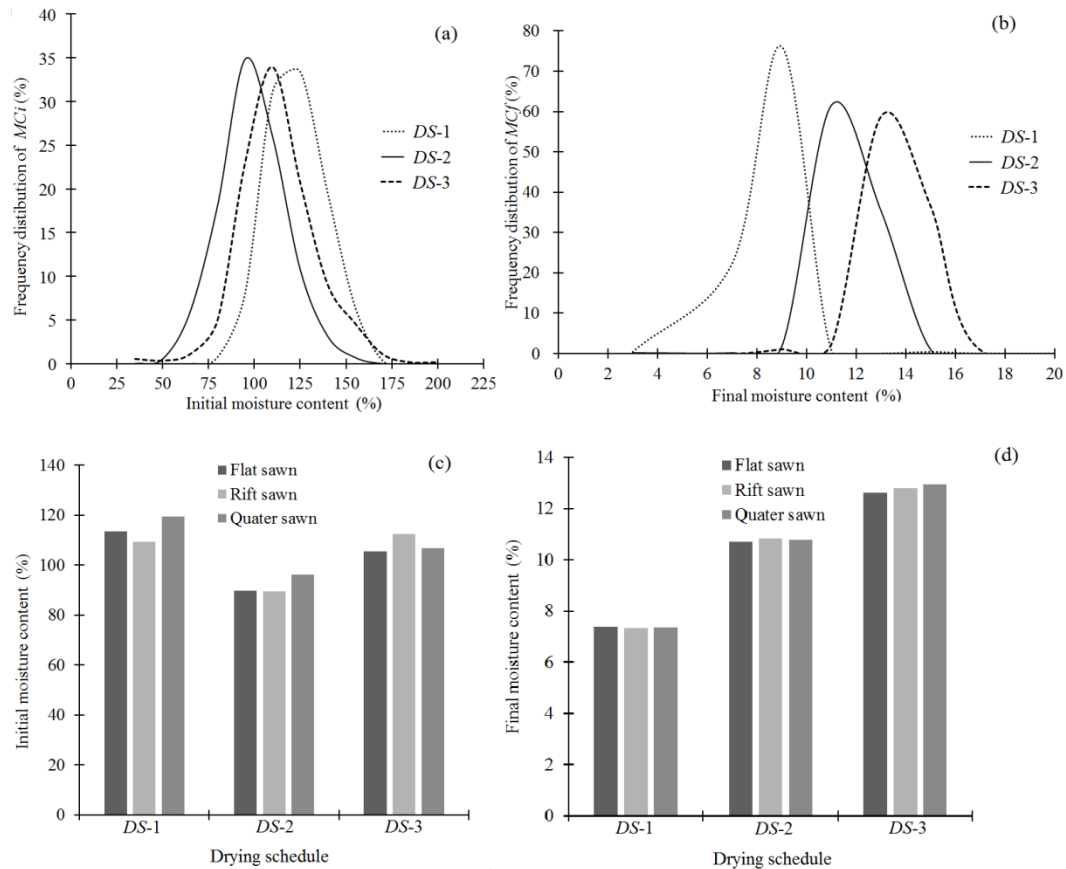

Fig. 2. Frequency distribution of the initial (a) and final moisture content (b). Initial moisture content (c) and final moisture content (d) by grain pattern type for the lumber used in the three drying schedules. Legend: *DS-1*: Drying Schedule 1; *DS-2*: Drying Schedule 2; *DS-3*: Drying Schedule 3

The grain pattern effect on the MC_i and MC_f values, showed that MC_i varies with grain pattern (Fig. 2 c-d and Table 3). Grain pattern affected the MC_i of treatments *DS-1* and *DS-2*, whereas the effect of MC_f was only significant on *DS-3*. The MC_i of dried lumber with flat sawn used in *DS-1* and *DS-2* was similar to the MC_i of lumber with rift sawn but different to MC_i of lumber with quarter sawn. Furthermore, the MC_i of dried lumber with quarter sawn was statistically equal to lumber with rift sawn (Fig. 2c). For *DS-3*, the MC_i of lumber for the three grain patterns was similar (Fig. 2c). Lumber used in *DS-3* showed no statistical differences in MC_i between the different grain patterns (Fig. 2c). The MC_f of dried lumber with *DS-1* and *DS-2* showed no statistical differences in the different grain patterns, whereas for dried lumber with *DS-3* statistical differences were found between lumber with flat sawn and quarter sawn (Fig. 2d).

The effect or presence of heartwood was significant in the MC_i and MC_f in the three drying schedules (Table 3). Heartwood increased significantly the MC_i in the 3 drying schedules, affecting negatively the MC_f .

Table 3. Value for F determined in the ANOVA for the grain pattern effect on MC_i and MC_f and the heartwood percentage significant level on MC_i and MC_f in wood of *T. grandis* according to the drying schedule.

Drying Schedule	Grain pattern		Heartwood (%)	
	Initial MC (%)	Final MC (%)	Initial MC (%)	Final MC (%)
<i>DS-1</i>	4.13*	0.09 NS	$107.8^{**} + 0.105^{**} \times HWP$	$7.7^{**} - 0.005^{**} \times HWP$
<i>DS-2</i>	8.52**	0.73 NS	$79.8^{**} + 0.17^{**} \times HWP$	$11.4^{**} - 0.009^{**} \times HWP$
<i>DS-3</i>	2.49 NS	5.68**	$86.0^{**} + 0.23^{**} \times HWP$	$13.3^{**} - 0.002^{**} \times HWP$

Legend: HWP: heartwood proportions, MC: Moisture Content. The different characters for grain pattern indicate statistical significances at 99% and ** in heartwood proportion indicate that this parameters is statistical significances at 99%, *DS*: Drying Schedule.

Drying time, average drying rate and moisture content variations

Drying time obtained for *DS-1* and *DS-2* was 110 and 140 hours, respectively, and 105 hours for *DS-3* (Table 2). In terms of average *DR*, dried lumber with *DS-3* showed the highest values (49.4% day⁻¹). Dried lumber with *DS-2* presented the lowest value (28.3% day⁻¹).

MC variation with time was similar in *DS-2* and *DS-3* but different in *DS-1*. The relationship was modeled through an exponential equation ($MC = a \cdot e^{-b \cdot t}$, where t: drying time, a y b: constants) with R^2 superior to 88% (Fig. 3).

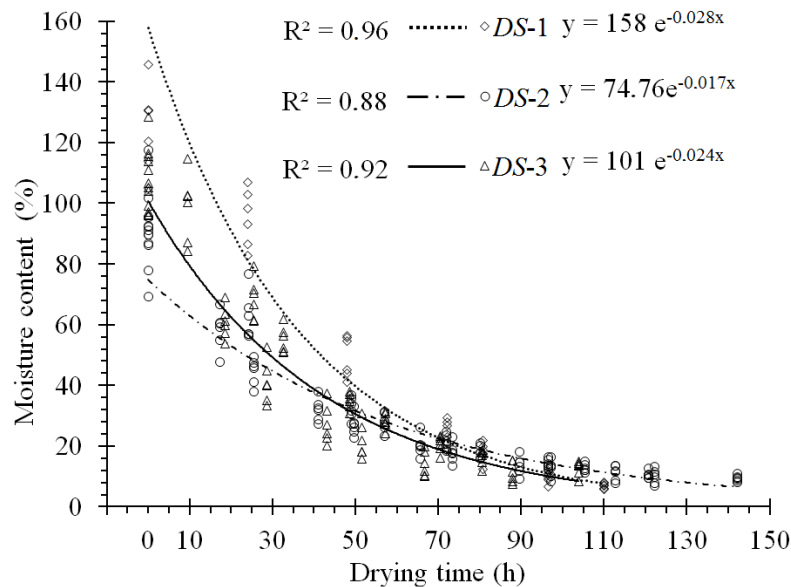

Fig. 3. Variation of moisture content of juvenile wood of *Tectona grandis* for three drying schedules in Costa Rica.

Legend: *DS-1*: Drying Schedule 1; *DS-2*: Drying Schedule 2; *DS-3*: Drying Schedule 3

Drying rate vs. moisture content

Two different trends were observed in drying schedules for the variation of *DR* with *MC* (Fig. 4). In *DS-1* and *DS-3*, having the lowest drying times, the relationship between *DR* and *MC* was directly proportional. A change in trend was observed when wood reached 80% of *MC* (Fig. 4a and 4c). For both drying schedules, the trend increased when *MC* decreased from 80% to 12%. For dried lumber with *DS-2* (slowest drying rate) two trends

were also observed but with the inflexion point at 40% of *MC* (Fig. 4b). In addition, for this slowest drying schedule no relationship was found between *DR* and *MC* from green condition until 40% of *MC*.

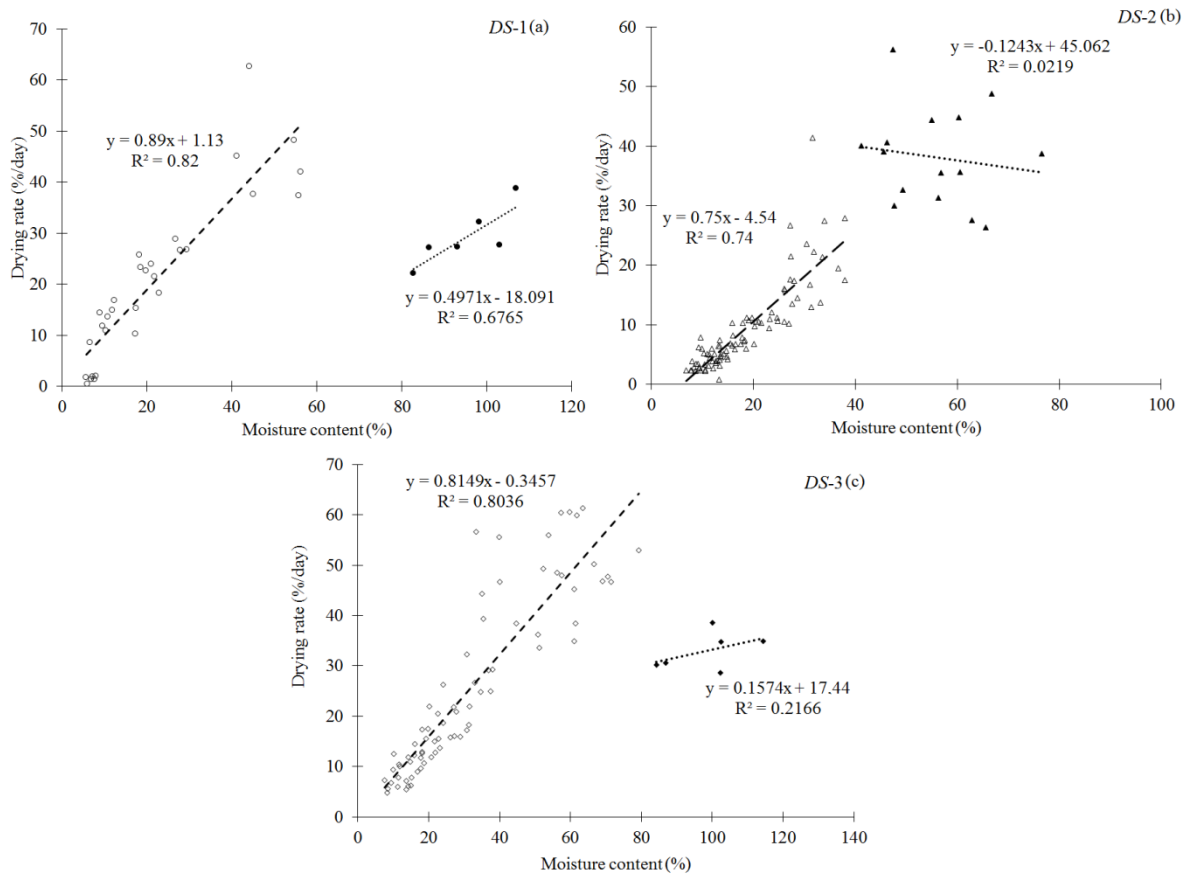

Fig. 4. Variation of drying rate by moisture content in the three drying schedules applied to juvenile wood of *Tectona grandis*.

Legend: ○ *DS-1*: Drying Schedule 1, trend 1, ● *DS-1*: Drying Schedule 1, trend 2; ▲ *DS-2*: Drying Schedule 2, trend 1
 ▲ *DS-2*: Drying Schedule 2, trend 2; ◆ *DS-3*: Drying Schedule 3, trend 1, ◆ *DS-3*: Drying Schedule 3, trend 2

Drying rate vs. drying time

DR decreased with drying time for all drying schedules (Fig. 5a). *DR* of *DS-1* decreased from 26% day⁻¹ to 4% day⁻¹ within a period of 72 to 110 hours. *DR* of *DS-2* decreased from 42% day⁻¹ to 4% day⁻¹ by the end of a 140-hour period. *DR* of *DS-3* decreased from 30% day⁻¹ to 14% day⁻¹ within a period of 72 to 96 hours. At the drying end (105 hours), *DR* steadily declined from 14% to 6% day⁻¹ (Fig. 5a). Modeling the variation of *DR* with time showed that the best fit model was a polynomial with grade 3 in dried lumber with *DS-1* and *DS-3*, whereas for dried lumber with *DS-2* the best fit model found was a polynomial of grade 2 (Fig. 5b).

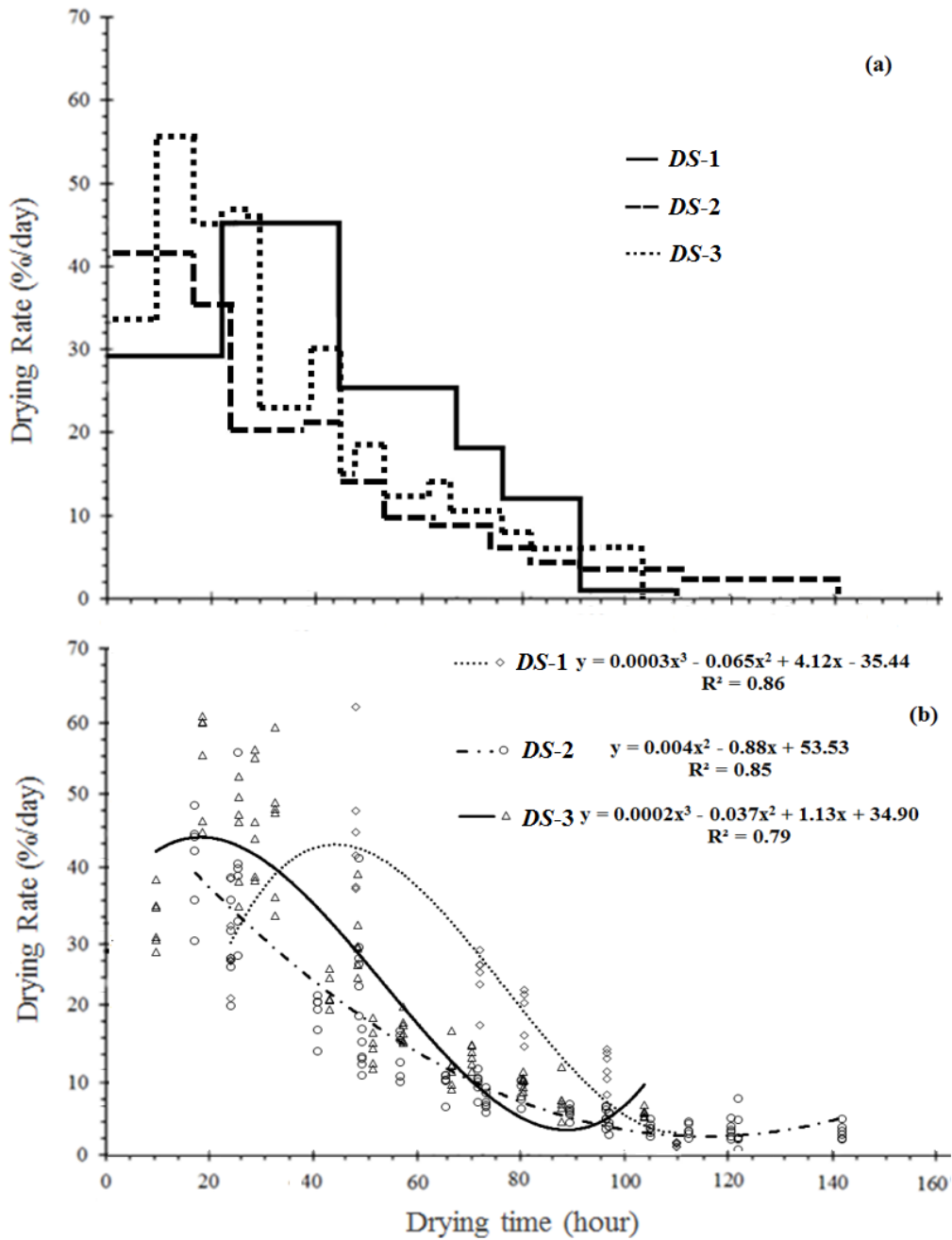

Fig. 5. Variation (a) and best fit model (b) of drying rate vs. drying time for the three drying schedules applied to juvenile wood of *Tectona grandis*.

Legend: *DS-1*: Drying Schedule 1; *DS-2*: Drying Schedule 2; *DS-3*: Drying Schedule 3

Energy consumption

The energy consumption for wood drying (using the different drying schedules) varied from 215 kW h to 305 kW h, where the slower drying (*DS-2*) consumed more energy compared to the faster drying, achieving an energy saving of 33% (Fig. 6)

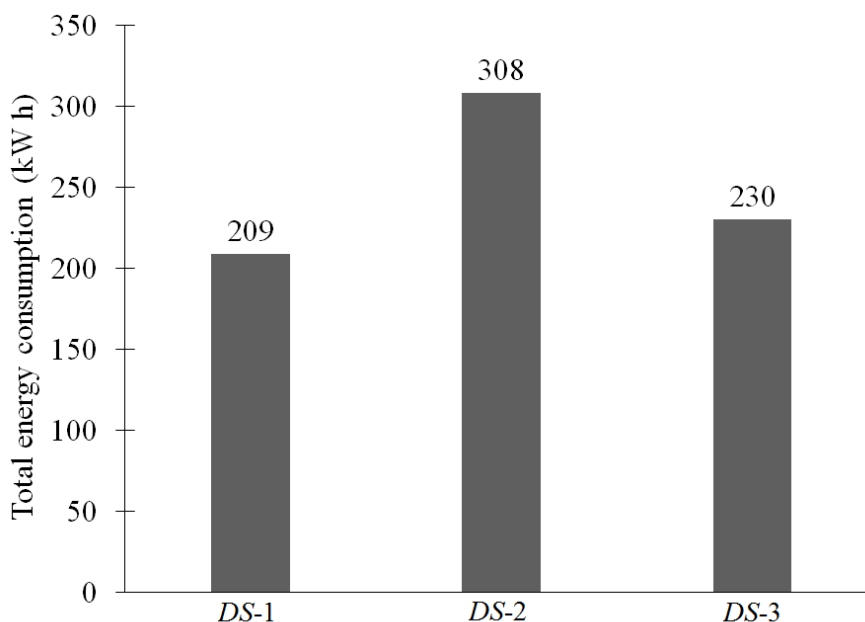

Fig. 6. Total energy consumption (kW h) of the three evaluated kiln drying schedules of juvenile wood of *Tectona grandis*. Legend: DS: Drying Schedule

DISCUSSION

Variation of MC_i of lumber before drying of *T. grandis* (91.5 to 114.7%) are superior to values of 57 to 109% reported by Salas and Moya (2014). Differences can be attributed to the maturity of wood (11 years), as Salas and Moya (2014) carried out their study on 14-year-old teakwood. MC_i of lumber obtained in the present study is similar to those reported for other plantation species in Costa Rica, such as *Gmelina arborea*, *Vochysia guatemalensis*, *Cordia alliodora*, *Enterolobium cyclocarpum*, *Vochysia ferruginea*, and *Acacia mangium* (Moya and Muñoz 2010, Moya *et al* 2011, Tenorio and Moya 2011, Tenorio *et al.* 2015), averaging MC_i greater than 100%.

Another important aspect related to MC_f is that, although the MC_f applied in the equalization and conditioning stages (by the end of drying cycle) and the MC target obtained was 10% for *DS-1* and 12% for *DS-2* and *DS-3*, the results of MC_f were slightly lower for *DS-1* and *DS-2*. The MC_f for dried lumber with *DS-3* (12.7%) was similar to the MC target. Variations of MC_f for dried lumber with *DS-1* and *DS-2* can be explained due to differences between the MC using electric moisture module and the MC determined with control samples. Although the "Control" samples were used to study the changes in the drying schedule, for the equalization and conditioning stages the control was performed using the electric moisture module of the dryer. These electric moisture modules have been determined for different wood species in previous studies but for tropical species there is few information on how to calibrate the module (Forsén and Tarvainen 2000). Consequently, differences can be found between the MC measured with this equipment and the real MC value, as happened in dried lumber with *DS-1* and *DS-2*. Furthermore, these drying procedures lacked of enough time for the equalization and conditioning of wood.

Total drying time (4-6 days) was lower than the 9-11 days reported by Salas and Moya (2014), and lower than that required to dry *Pinus radiata* (Ananias *et al.*, 2012), one of the fastest species for kiln drying.

The average drying rate (28.3 to 49.4% day⁻¹) were found to be higher than values reported for other tropical plantation species, for instance from 4.8 to 30.5% day⁻¹ (Moya *et al.* 2013). These differences with other species are attributed to the variations in inherent characteristics of wood (Denig *et al* 2000, Klitzke and Batista, 2010), to characteristics of the drying chamber (Espinoza *et al* 2007) and to system conditions (temperatures, relative humidity and wind speed) used during drying (Denig *et al.* 2000).

Present values, compared to other studies such as Salas y Moya (2014), showed a higher DR to the reported for *T. grandis*, however, differing in wood age, which probably had an influence on water permeability and mobility within the wood (Moya *et al.*, 2014).

Drying rate vs. moisture content

The correlation coefficients (R^2) in the linear models for the three drying schedules for the relationship between *DR* and *MC* suggest that the *MC* of lumber is a feasible indicator of *DR* variation. The decrease of *DR* with the reduction of the *MC* is influenced by the different water types present in wood (Walker, 1993, Tenorio *et al.* 2015). During the initial stages of kiln-drying free water leaves cell lumens and intercellular spaces more easily and with less energy consumption (Skaar and Siau 1981, Denig *et al* 2000). However, for *MC* the major proportion of water locates in the cell walls, moving through cell walls by diffusion and making the evaporation more difficult to occur (Walker, 1993). Consequently, *DR* decreases.

The difference found in the inflexion points for three drying schedules is influenced by *MC_i* variations of wood. Dried lumber with *DS-1* and *DS-3* have a *MC_i* over 100%, whereas dried lumber with *DS-2* (slow drying) has a *MC_i* lower to 80%. A high *MC_i* causes a higher *DR* because water over 100% is easily and rapidly removed from wood (Tenorio *et al.*, 2015). This reaction generated different trends regarding *MC* and drying rate in the three different drying schedules with high *MC*.

Several authors indicated that one of the most influential factors for *DR* is heartwood presence in wood (Skaar 1972, Simpson and Baah 1989). However, this type of tissue does not appear to have an influence on the relationship between *DR* and *MC* or on the inflexion points.

Variations of *DR* with *MC* and in the inflexion points have been also found in other tropical species growing in plantation conditions (Tenorio *et al.*, 2015). These authors found that wood of *Enterolobium cyclocarpum* and *Samanea saman* have inflexion points at 80% and 40%, similar to values found in the present study. However, these authors attributed the inflexions to the relationship between *DR* and *MC* to different water diffusion degrees in sapwood and heartwood.

Drying rate vs. drying time

Although it was established, before starting drying, that DR should remain in $20\% \text{ day}^{-1}$ for the first 3 days until lumber reached 30% and thereafter stabilized in $8\% \text{ day}^{-1}$ until finishing with drying, this was not achieved. The relation between DR and drying time is highly influenced by the variations of dry-bulb and wet-bulb temperatures (DBT and WBT respectively) during the drying process (Tenorio *et al.* 2015). During the drying stage, dry-bulb depression (DWB) increased as MC decreased for the 3 drying schedules. In the slowest drying schedule ($DS-2$), a DWB of 4 to 25°C in 8 drying stages was applied with changes of approximately 2°C in DWB , and increasing from 5°C in DBT after the fourth stage until 75°C . For the drying schedules with less drying time ($DS-1$ and $DS-3$), DWB increased 4°C for each drying stage and increased from 10°C to 75°C for $DS-1$. For $DS-3$, the increment of DR remained the same for all stages with a DWB of 3°C per stage and a final DBT temperature of 80°C .

Consistent with Tenorio *et al.* (2015) inflexions found in the modeling of DR variations regarding MC were produced by a great DWB change, which helped to improve drying time when applied at the beginning of drying (at 80% MC) like $DS-1$ and $DS-3$. This implied a less energy consumption but with a higher change when wood reaches 40%, the case of $DS-2$ that caused drying to be slower and with higher energy consumption.

CONCLUSIONS

The MC_i of the evaluated wood of *T. grandis* varied from 91.6% to 114.7% and the MC_f varied 2.0%, this in relation to the targeted MC . The variation coefficient obtained with MC_i and MC_f values ranged from 8 to 14%, which is considered as uniform values of drying.

Drying rate of 20 day^{-1} was used during the first 3 days and then DR remained in $8\% \text{ day}^{-1}$ until the treatment ended, allowing to reduce the drying time in *T. grandis* wood from young trees to 105 to 110 hours (4-5 days) and under low energy consumption.

Drying rate decreases with drying time. However, a change in the trend occurs when MC in lumber is 80% for fast drying and 40% for slow drying.

The use of drying rate to control drying schedules length was affected, as expected, by the time of the treatment, which happened to be a relationship between the conditions for wet-bulb temperature and the dry-bulb depression during the drying process.

ACKNOWLEDGMENTS

The authors wish to thank the *Vicerrectoría de Investigación y Extensión* at the *Instituto Tecnológico de Costa Rica (ITCR)*, and *Life Forestry Costa Rica S.A.* for providing the raw material and other help for the study.

REFERENCES

- ASTM (2012) D-4442-07. Standard Test Methods for Direct Moisture Content Measurement of Wood and Wood-Base Materials. American Society for Testing and Materials, West Conshohocken, PA.
- Ananias RA, Ulloa J, Elustondo DM, Salinas C, Rebolledo P, Fuentes C (2012). Energy consumption in industrial drying of radiata pine. *Drying Techn* 30(7): 774-779.
- Basri E, Wahyudi I (2013) Wood Basic Properties of Jati Plus Perhutani from different ages and their relationships to drying properties and qualities. *Journal Penelitian Hasil Hutan* 31(2): 93-102
- Carlsson P, Arfvidsson J (2007) Optimized wood drying. *Drying Techn* 18: 1779–1796.
- Denig J, Wengert EM, Simpson WT (2000) Drying hardwood lumber. Forest Products Laboratory-USDA, Madison, WI. 138 pp.
- Espinoza O, Bond BH, Araman P (2007) A survey of Bolivian lumber drying operations. *Forest Prod J* 57(6): 88-92.
- Forsén H, Tarvainen V (2000) Accuracy and functionality of hand held wood moisture content meters. Technical Research Centre of Finland. ESPOO. VTT Publications 420 pp.
- Gu H, Young T, Moschler W, Bond B (2004) Potential sources of variation that influence the final moisture content of kiln-dried hardwood lumber. *Forest Prod J* 54 (11):65-70
- Hsueh A, Jing-Sheng N (1997) Study on the kiln drying of teak, India-charcoal trema, Formosan alder and schefflera tree 3-cm thick lumber. *Bull National Pingtung Polytechnic Ins* 6(1): 41-48
- Klitzke RJ, Batista DC (2010) Tests of drying rate and scoring of defects for the prediction of conventional kiln drying quality of Eucalyptus wood. *Scientia Forestalis* 38(85): 97-105.
- Moya R (2007) Industrialización y comercialización de madera proveniente de plantaciones forestales en Costa Rica. *Recursos Naturales y Ambiente* 49:154-162.
- Moya R, Bond B, Quesada-Pineda H (2014) A review of heartwood properties of *Tectona grandis* trees from fast-growth plantations. *Wood Sci Techn* 48(2): 411-433
- Moya R, Muñoz F (2010) Physical and mechanical properties of eight species growing in fast growth plantations in Costa Rica. *J Trop For Sci* 22: 317–328.
- Moya R, Urueña E, Salas C, Muñoz F, Espinosa O (2013) Kiln drying behavior of lumber from ten fast-growth plantation species in Costa Rica. *Wood Mat Sci Eng* 8: 37-45.
- Moya R, Aguilar D, Tenorio C, Bond B (2011) Variation of moisture content in kiln dried plantation grown lumber of *Vochysia guatemalensis*. *Wood Fiber Sci* 43: 121-129.
- Murphy JT, Schindler S (2011) Globalizing development in Bolivia? Alternative networks and value-capture challenges in the wood products industry. *J Economic Geography* 11: 61-85.
- Oltean L, Teischinger A, Hansmann C (2009) Influence of low and moderate temperature kiln drying schedules on specific mechanical properties of Norway spruce wood. Proceedings of the International Conference Wood science and engineering in the third millennium, Transilvania University of Braşov, România, p.103–110.

- Pleschberger H, Hansman C, Müller U, Teischinger A (2013) Fracture energy approach for the identification of changes in the wood caused by the drying processes. *Wood Sci Technol* 47:1323–1334
- Salas C, Moya R (2014) Kiln-, solar-, and air-drying behavior of lumber of *Tectona grandis* and *Gmelina arborea* from fast-grown plantations: moisture content, wood color, and drying defects. *Drying Techn* 32:301-310
- Schneider CA, Rasband WS, Eliceiri KW (2012) NIH Image to ImageJ: 25 years of image analysis. *Nature Methods* 9: 671–675
- Sidney R, Charles J, Kozlik P, Bois J, Wengert E (1988) Dry kiln schedules for commercial woods: temperate and tropical. Gen Tech Rep FPL-GTR-57 USDA For Serv, Forest Prod Lab, Madison, WI.
- Simpson W (1991) Properties of wood related to drying. In *Dry Kiln Operator's Manual Handbook AH-188*; Simpson W, Ed.; USDA For Serv, Forest Prod Lab, Madison, WI, pp. I1–I50.
- Simpson WT, Baah CK (1989) Grouping tropical wood species for kiln drying. Res Note FPL-RN-0256 USDA For Serv, Forest Prod Lab, Madison, WI.
- Skaar C (1972) *Water in wood*, 1st Ed.; Syracuse University Press: Syracuse, NY, 145 p.
- Skaar C, Siau JF (1981) Thermal diffusion of bound water in wood. *Wood Sci Techn* 15: 102-112.
- Tenorio C, Moya R (2011) Kiln dry of *Acacia mangium* (Willd): moisture content, wood color and drying defects after and before drying. *Drying Techn* 29(15): 1845-1854.
- Tenorio C, Salas C, Moya R (2015) Kiln drying behavior utilizing drying rate of lumber from six fast-growth plantation species in Costa Rica. *Drying Techn* (In press).
- Walker JCF (1993) *Water in Wood*. In: *Primary Wood Processing, Principles and Practice*. Springer Verlag, Netherlands. pp 68-94.

2. **Artículo 2. Kiln Drying of plantation-grown *Tectona grandis* wood with daily-controlled drying rate schedules: Effects on the final moisture content, drying time, wood colour and drying defects.**
-

KILN DRYING OF PLANTATION-GROWN *TECTONA GRANDIS* WOOD WITH DAILY-CONTROLLED DRYING RATE SCHEDULES: EFFECTS ON THE FINAL MOISTURE CONTENT, DRYING TIME, WOOD COLOUR AND DRYING DEFECTS

Alexander Berrocal

Escuela de Ingeniería Forestal, Instituto Tecnológico de Costa Rica

Apartado 159-7050, Cartago, Costa Rica

E-mail: aberrocal@itcr.ac.cr

María Rodríguez-Solis

Escuela de Ingeniería Forestal, Instituto Tecnológico de Costa Rica

Apartado 159-7050, Cartago, Costa Rica

E-mail: maria.rodriguez@itcr.ac.cr

Róger Moya†*

Escuela de Ingeniería Forestal, Instituto Tecnológico de Costa Rica

Apartado 159-7050, Cartago, Costa Rica

E-mail: rmoya@itcr.ac.cr

Freddy Muñoz

Escuela de Ingeniería Forestal, Instituto Tecnológico de Costa Rica

Apartado 159-7050, Cartago, Costa Rica

E-mail: fmunoz@itcr.ac.cr

* Corresponding author

KILN DRYING OF PLANTATION-GROWN *TECTONA GRANDIS* WOOD WITH DAILY-CONTROLLED DRYING RATE SCHEDULES: EFFECTS ON THE FINAL MOISTURE CONTENT, DRYING TIME, WOOD COLOUR AND DRYING DEFECTS

Abstract

Measurements were performed in order to compare the drying speed between the schedules rather than to reduce the drying time by employing high daily drying rate (DR_{daily}) in *Tectona grandis* wood. And it was evaluated the moisture content (MC), drying defects (twists, bows, cups, crooks, checks and splits), drying tensions, and colour changes of these schedule. Results showed that it is possible to dry wood in 88 hours by employing drying schedules with a high DR_{daily} with no significant variability in the final MC of the dried-lumber. Utilization of such schedules increased the incidence and magnitude of twist, crook, bow and split defects, while decrease in cup and check defects were observed. However, it is possible to obtain a lower incidence of drying defects by using an endless screw for daily adjustment of the lumber piles during drying. Drying tensions decrease with drying schedules with a high DR_{daily} , but slightly increase when endless screws are used. Finally, application of drying schedules with high DR_{daily} produces variation in the colour of the lumber, yielding more reddish (a^*) and yellowish (b^*) wood.

Key words: drying rate, *Tectona grandis*, wood colour, drying defects, index of quality, kiln drying.

Introduction

Wood drying is an important stage of the manufacturing process as it contributes towards dimensional stability and workability of lumber, as well as wettability of the finish and adhesive, besides other wood properties (Oltean *et al.*, 2007). Drying performance varies for each species, then different methods are employed for the drying of lumber (Carlsson & Arfvidsson, 2007). One of the most important is kiln drying, but investment and operation costs are high and it demands qualified labour and complex humidity control systems (Oltean *et al.*, 2007).

One advantage of kiln drying is that the drying rate can be controlled in short periods (Carlsson & Arfvidsson, 2007). The drying rate (loss of humidity within a time period) is a variable that can positively influence the drying time and quality of dried-lumber. This parameter is affected by characteristics such as the properties inherent to the lumber (Denig *et al.*, 2000; Tenorio *et al.*, 2015), the drying chamber and drying conditions, specifically: temperature, relative humidity and air speed (Denig *et al.*, 2000).

The study and knowledge of the drying rate (DR) can aid in decreasing the drying time, especially in species from temperate climates (Denig *et al.*, 2000). However, research on the drying rate of juvenile wood from tropical fast-grown plantations has been limited to a few species. More recently, Tenorio *et al.* (2015) studied

the effect of the drying time and the moisture content variations upon the *DR* —measured daily in several tropical species— in order to improve efficiency in the drying times of the species studied.

On the other hand, *Tectona grandis* is the most important species for commercial reforestation in tropical climates (Moya *et al.*, 2014). Nonetheless, Moya *et al.* (2013) determined that *T. grandis* is one of the species with the highest drying time and presence of drying defects when compared to other tropical species from plantations in Costa Rica. Salas and Moya (2014) found that this species showed a drying time between 9 and 11 days and, additionally, they report that drying defects increase when kiln drying is employed. The prolonged process of drying, together with a high percentage of juvenile wood (Moya *et al.*, 2014), the appearance of drying defects (Salas & Moya, 2014) and failure in achieving a uniform colour in the dried-lumber are all inconveniences when competing with other tropical woods.

The objective of this study was to evaluate the final moisture content, drying defects (warp, split and check), drying tensions and colour in wood of juvenile *Tectona grandis* from fast-growing plantations, using three different drying schedules controlled by daily drying rate (DR_{daily}) as a way to decrease the drying time. Furthermore, the use of endless screws on the lumber piles to maintain the boards pressed and avoid formation of warps in the wood was evaluated.

Materials and methods

Plantation characteristics and sawing pattern: Wood samples were taken from a second thinning in an 11-year-old *Tectona grandis* plantation, with 3 x 3 m spacing (1100 trees ha⁻¹). Stand density was 475 trees ha⁻¹ at sampling time, with an average diameter at breast height (*DBH*) of 23 cm and a total height of 14 m. Sampled trees came from thinned trees. The grain pattern used for the present study was the one commonly implemented in Costa Rica for timber from forest plantations to produce 25-mm-thick boards (Moya *et al.* 2013). A total of 1200 edged 25-mm-thick boards were obtained.

Drying schedules: Three different drying schedules were tested. The first schedule named “Drying schedule 1” (*DS-Standard*) was recommended by Sydney *et al.* (1998) for *T. grandis*, specifically the “H” schedule. Although this program has achieved good results in dried-lumber quality, the drying times reached by Moya *et al.*, (2013) and Salas and Moya (2014), in the opinion of the authors are larger for wood from fast-growth plantations trees and wood from plantation trees have presented good quality in relation to drying defects. For second drying schedule (*DS-2*), the parameters of drying conditions (temperature and equilibrium moisture content) of *DS-standard* were modified for increasing the daily drying rate (DR_{daily}). To achieve this, 3 additional steps were added to the previous schedule (*DS-standard*). A step was added between the first and the second steps of *DS-Standard*, in order to reduce the *EMC* difference. The second additional step was added between the second and third steps to reduce temperature and *EMC* difference between steps. And the third additional step was added before the last steps of the drying stage, where the *EMC* was reduced (Table 1). The third schedule (*DS-3*) aimed at reducing again the drying time, and it was similar to *DS-2*. For this

schedule (*DS-3*), the same stages of *DS-2* were used, but higher dry-bulb temperature was implemented in the end drying, the temperature increased in 5 °C (Table 1).

Table 1. Different drying schedules utilized for increasing daily drying rate and decreasing drying time of wood of *Tectona grandis* in kiln drying

Step	Drying schedule 1			Drying schedules 2			Drying schedules 3		
	<i>DS-standard</i>			<i>DS-2</i>			<i>DS-3</i>		
	<i>DB</i>	<i>EMC</i>	<i>MC</i>	<i>DB</i>	<i>EMC</i>	<i>MC</i>	<i>DB</i>	<i>EMC</i>	<i>MC</i>
	°C	%	%	°C	%	%	°C	%	%
Heating	55	-	60	55	-	-	55	-	-
	58	14	60	-	-	-	58	14	-
Drying	60	13.8	30	60	13.8	60	58	14.0	60
	60	10.0	25	60	12.5	50	60	12.5	50
	70	7.7	20	60	10.0	40	60	10.0	40
	70	6.4	20	65	8.5	35	65	8.5	35
	75	3.7	10	70	7.7	25	70	7.7	30
				75	6.4	25	75	6.4	25
				75	5.2	15	80	5.0	20
				75	3.7	12	80	3.7	12
Equalisation	75	11.0	-	75	11.0	12	80	11.0	12
Conditioning	75	11.5	-	75	11.5	-	80	11.5	-
Cooling	35	11.5	-	35	-	-	35	-	-

Legend: *DB*: Dry bulb temperature °C / *EMC*: Equilibrium moisture content % / *MC*: Moisture content %

The three drying schedules tested were performed in a conventional kiln with a 2 m³ capacity and using an electrical power source to heat the resistance inside the chamber. The green lumber was stacked in packages of 10 boards wide and 30 pieces height, obtaining 300 pieces per drying charge. Cross-sectional pieces of 2.5x2.5 cm were used as stickers between the layers. Each drying schedule was performed in duplicate; therefore, 6 different drying charges were completed.

Treatments for reduction of drying defects: Reduction of defects consisted in the placement of endless screws with plates that traversed the pile of wood from side to side (Figure 1a); daily adjustments were made with the aid of the nuts on the screw (Figure 1b) in order to maintain the boards pressed and thus avoid formation of twists in the wood. Five treatments were applied: (i) *DS-standard* treatment without endless screws; (ii) *DS-2* treatment without endless screws; (iii) *DS-2* treatment with endless screws; (IV) *DS-3* treatment without endless screws; and (V) *DS-3* treatment with endless screws.

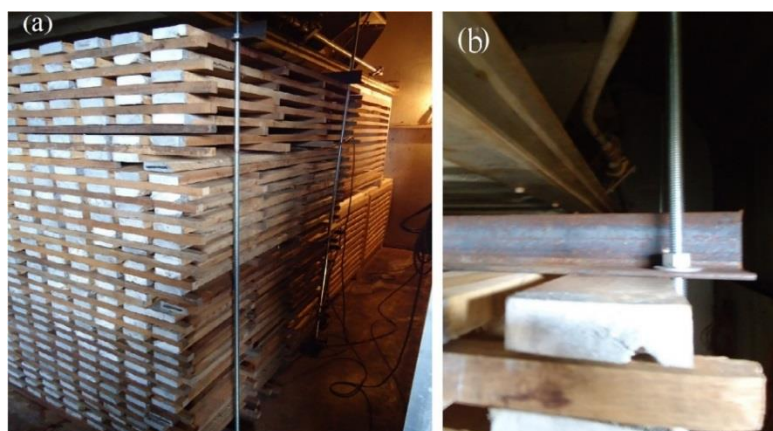

Figure 1. (a) endless screw location in lumber stacked in piles; and (b) nuts and washer in endless screw for daily adjustment during drying.

Control of moisture content: For *MC* control, six samples were obtained from the centre of six stacked representative boards for each drying method (Simpson, 2000). These samples were placed at different heights at each side of the pile. Two samples were located at 25 cm from the ground, another two samples were located at 25 cm from the top and the last two samples were located at 50 cm from the other samples. The target *MC* was 12%.

Evaluation of drying defects: The defects were measured before and after drying and the parameters evaluated were warps (twists, crooks, bows and cups), splits, cracks and collapses. The methodology detailed in Salas and Moya (2014) and Tenorio *et al.* (2012) was used to evaluate all the drying defects. The official Chilean standard Nch993EO72 was used to determine the Index of Quality (*IQ*), which was computed for twists, crooks, cups, bows, checks and splits according to Equation 1 (Pérez *et al.*, 2007). And its values and the means were detailed in Salas and Moya (2014) and Tenorio *et al.* (2012).

$$I = \frac{(Na*0)+(Nb*0,5)+(Nc*2)+(Nd*2,5)}{M} \quad (1)$$

where:

I: quality index

Na: number of pieces without any presence of warp, split or check.

Nb: number of pieces with a slight presence of warp, split or check.

Nc: number of pieces with a moderate presence of warp, split or check.

Nd: number of pieces with a severe presence of warp, split or check.

M= total number of pieces.

Determination of drying tensions: By the end of the drying process, 6 whole pieces of *T. grandis* were selected randomly for each one of the 5 treatments evaluated. Three transversal sections (2 from the ends and 1 from the centre) were obtained from each one of these pieces. The transversal sections were used to

determine the drying tensions immediately after the drying and another one 24 hours after the drying, according to the methodology proposed by Korkut and Guller (2007). This method classifies drying tensions in 3 categories: severe, moderate and slight.

Evaluation of colour: Colour was determined for 42 pieces randomly chosen before the drying for each one of the treatments, selecting only the heartwood within the area of measurement. After the drying, colour was again measured in the same area selected. To obtain the values for the CIEL*a*b* standardised chromatological system, a spectrophotometer model miniScan XE Plus was employed. The information detailed of color measuring conditions is described detailed in Berrocal et al. (2016b). Colour change (ΔE^*) was determined by means of the L^* , a^* and b^* values measured before and after the drying, calculated according to the formula established in the ASTM D 2244 standard.

Statistical Analysis: One-way ANOVA was applied to initial and final MC and wood colour parameters (L^* , a^* and b^*) measured in the different drying schedules, to determine whether there were significant differences for each parameter. The Tukey test was used to test the mean difference at a significance level of $p < 0.01$. The SAS 8.1 statistics program for Windows (SAS Institute Inc., Cary, N.C.) was used to carry out the analyses. Regarding quality evaluation, each defect was analysed based on its percentage of incidence and the magnitude of severity before and after drying.

Results

Drying time and drying rate: Drying times varied from 88 ($DS-3$ without endless screws) to 142 hours ($DS-2$ with endless screws) and there is evidence that the drying time was reduced with $DS-3$ (Table 2). Although significant statistical differences were observed between the drying times of $DS-standard$ and $DS-2$ (Table 2), the objective of decreasing the drying time was not accomplished in the latter schedule.

Moisture content: Before drying, teak lumber showed a variation in the initial moisture content (MC_i) from 86% to 115% in the different drying schedules, reporting a significant statistical difference (Table 2). Lumber from $DS-2$ showed MC_i values inferior to 100%, whereas for the rest of lumber of the other schedules, the MC_i was over 100%. However, low MC_i values do not determine a greater drying rate nor a lower drying time, as the lowest drying time and the highest drying rate at $2.09\% \text{ hour}^{-1}$ were obtained even with a MC_i over 100%. As it seems, this variation in MC_i did not show an influence on the drying time, since the lower drying times presented MC_i values similar or even lumber with superior to those values presented for the lower drying times (Table 2). Final moisture content (MC_f) of the dried-lumber was close to 12% and no statistical difference appeared among the different batches (Table 2), therefore the application of drying schedules with the purpose of decreasing the drying time again does not alter the MC_f of lumber. Likewise, it is important to note that low coefficients of variation, from 8.05% to 8.82%, appeared in dried-lumber from

the different drying schedules, contrary to the MC_i , for which the coefficients of variation were slightly higher, from 14.30% to 19.31% (Table 2).

Table 2. Initial and final moisture content, drying time and average drying rate data obtained from the different drying schedules utilized for increasing daily drying rate and decreasing drying time of *Tectona grandis* wood.

Drying Schedule	Initial MC (%)	Final MC (%)	Drying time (hour)	Average drying rate (% hour ⁻¹)
<i>DS-standard</i> without endless screws	114.7 (14.30) ^A	11.7 (8.82) ^A	110	1.74
<i>DS-2</i> without endless screws	85.9 (17.21) ^B	12.1 (6.45) ^A	122	1.19
<i>DS-2</i> with endless screws	96.8 (19.26) ^C	12.4 (8.34) ^A	142	1.16
<i>DS-3</i> without endless screws	101.1 (19.31) ^D	12.4 (8.48) ^A	88	2.09
<i>DS-3</i> with endless screws	111.4 (16.95) ^A	13.0 (8.05) ^A	104	1.99

Note: Different letters indicate statistical significances at 99%. The values in parentheses represent the coefficient of variation.

MC : Moisture content.

Wood quality before drying: Before the drying process, lumber showed little to no incidence of twists, cups or checks (Figure 2a, 2d and 2e, respectively). Incidence of crooks, bows and splits was present in green lumber (Figure 2b, 2c and 2f). The incidence of twists, cups, checks and splits increased with the drying process (Figure 2a, 2f), whereas the incidence of crook and bow defects decreased instead (Figure 2b and 2c).

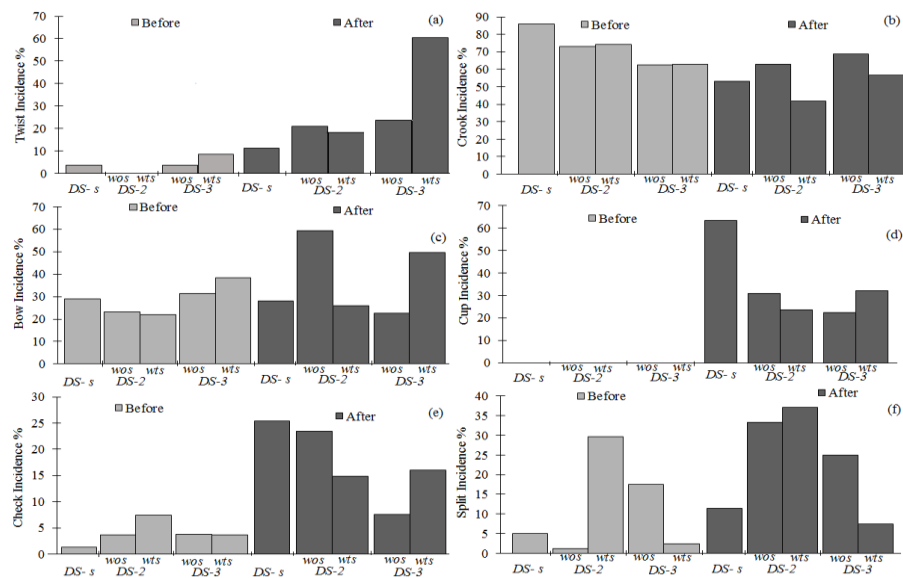

Figure 2. Percentage of incidence of twist (a), crook (b), bow (c), cup (d), check (e) and split (f) defects obtained for different drying schedules utilized for increasing daily drying rate and decreasing drying time of

Tectona grandis wood. **Legend:** *DS-s*: Drying Schedule standard; *DS-2*: Drying Schedule 2; *DS-3*: Drying Schedule 3; *wos*: without endless screws; *wts*: with endless screws.

Wood quality after drying

The dried-lumber quality using Index of quality showed that in *DS-standard* twist were cataloged as “excellent”, but crook defects was classified as “Good”. Other drying defects the dried-lumber was cataloged as “Very good” quality (Table 3). Meanwhile *DS-2* the dried-lumber quality was similar than *DS-standard*, but dried-lumber quality was slightly lower in *DS-3* for twist, cup, check and split (Table 3)

Table 3. Classification of dried-lumber obtained for different drying schedules utilized for increasing daily drying rate and decreasing drying time of *Tectona grandis* wood.

Drying Schedule	Evaluation	Twist	Crook	Bow	Cup	Check	Split
Classification	<i>DS-standard</i>	Excellent	Good	Very Good	Very Good	Very Good	Very Good
	<i>DS-2</i> without endless screws	Very good	Good	Good	Very good	Good	Good
	<i>DS-2</i> with endless screws	Very good	Very Good	Very Good	Very good	Very Good	Very Good
	<i>DS-3</i> without endless screws	Very good	Good	Good	Very good	Very Good	Very Good
	<i>DS-3</i> with endless screws	Very good	Good	Very good	Very good	Very Good	Very Good

Twist defects: Incidence of twists in dried-lumber increased where the drying schedules with controlled DR_{daily} (*DS-2* and *DS-3*) aiming at decreasing the drying time were used (Figure 2a), in comparison with *DS-standard*. The IQ_{after} value in dried-lumber from *DS-2* and *DS-3* is greater than that of dried-lumber from *DS-standard* (Figure 3a). Moreover, it was observed from the two schedules used to reduce drying time with controlled DR_{daily} that incidence of twist defects is similar either using or not endless screws to dwindle defects. Another finding is that the greatest incidence of defects was produced by the schedule with a greater DR_{daily} (*DS-3* with endless screws) (Figure 3a). Concerning quality of the lumber and the use or not of endless screws, in *DS-2* and *DS-3* the IQ_{before} value increased when screws were not employed (Figure 3a), hence the decrease in lumber quality from twist defect.

Crook defects: When no endless screws were used on the pile, incidence of crooks in dried-lumber increased in the drying schedules with high DR_{daily} used to reduce drying time (*DS-2* and *DS-3*) in comparison with *DS-standard*. Meanwhile, when screws were used, incidence of this defect decreased (Figure 2b). *DS-2* showed lower IQ_{after} values than those found in *DS-3* (Figure 3b). In drying schedules with a high DR_{daily} for reduction of drying time (*DS-2* and *DS-3*), the IQ_{after} value grows when no endless screws are used. However, use of

screws to maintain the pile of lumber with the least possible movement produces lower IQ_{after} values in dried-lumber (Figure 3b). This value is nonetheless lower in *DS-standard* than in *DS-2*.

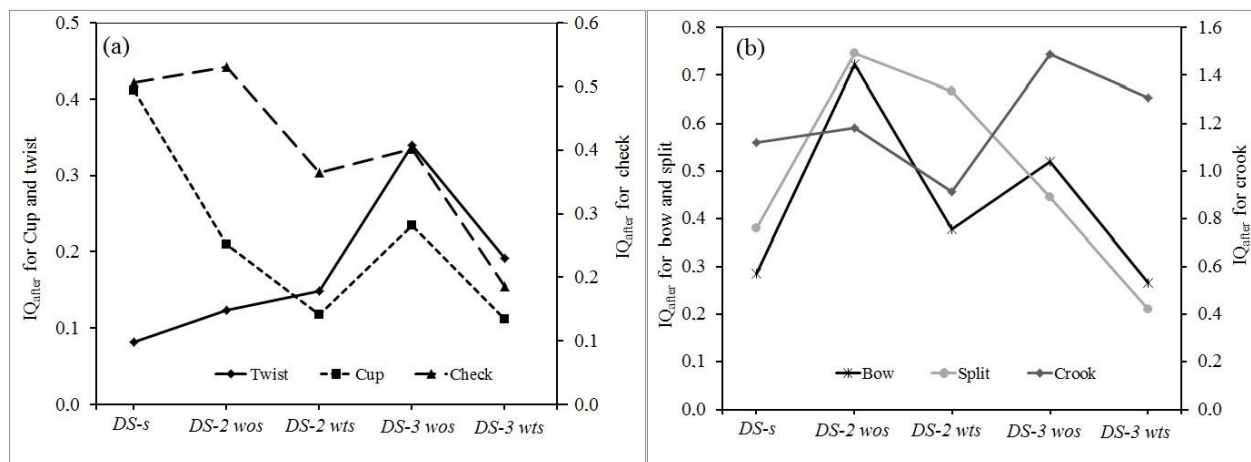

Figure 3. Index of quality before drying (IQ_{before}) for (a) cups, twists, checks and (b) bows, splits and crooks in dried-lumber from different drying schedules utilized for increasing daily drying rate and decreasing drying time of *Tectona grandis* wood.

Legend: *DS-s*: Drying Schedule standard; *DS-2*: Drying Schedule 2; *DS-3*: Drying Schedule 3; *wos*: without endless screws; *wts*: with endless screws.

Bow defects: Incidence of this defect is augmented by the use of schedules with a high DR_{daily} for reduction of drying time. This is the case in *DS-2* without screws, though when using screws incidence is a little less in relation to *DS-standard* (Figure 2c), while for dried-lumber from *DS-3* without screws it is lower than in *DS-standard*. Meanwhile, use of endless screws increases the incidence in *DS-2* and *DS-3* with a high DR_{daily} to reduce the drying time (Figure 2c). Lumber dried with *DS-standard* shows an IQ_{before} value of 0.22, but this value increases with schedules of high DR_{daily} for reduction of the drying time (Figure 3b). Additionally, it was observed in *DS-2* and *DS-3* that the IQ_{after} value for dried-lumber decreases when screws are employed. Nevertheless, in *DS-2* the IQ_{after} values are inferior to those of *DS-3* with the screws (Figure 3).

Cup defects: For this defect, the incidence decreases when schedules of high DR_{daily} are employed for reduction of drying time (Figure 3d). The use of screws to avoid defects was more effective in *DS-2*, whereas in *DS-3* the incidence rose slightly (Figure 2c). In the evaluation for quality of the dried-lumber, the IQ_{after} was lower in schedules aiming at decreasing the drying time, either with or without the use of screws while, for *DS-2* and *DS-3*, the use of screws was observed to decrease this value (Figure 3a).

Checks presence: Presence of checks in lumber before the drying is low, increasing after drying with any of the drying schedules (Figure 2e). The *DS-standard* produced the highest incidence of this defect, while using a drying schedule with a high DR_{daily} to reduce drying time also decreases incidence. The use of screws and plates on the pile to avoid defects was more effective in *DS-2*, as incidence decreased; the opposite occurred

with *DS-3*, where it caused the incidence of defects to rise (Figure 2e). In the evaluation of quality it was seen that the IQ_{before} values are lower than 0.18, while for dried-lumber the IQ_{after} value increased, in addition to reducing the incidence of checks with the use of drying schedules with a high DR_{daily} (Figure 3). In this way, an increase in quality was achieved. On the other hand, use of the plate and screws system to avoid defects on the pile decreases the IQ_{after} value in both schedules with a high DR_{daily} (Figure 3b). It was possible as well to observe in these two schedules that the drying of lumber with *DS-3* yields lower IQ_{after} values than those obtained through *DS-2* (Figure 3a).

Splits presence: Dried-lumber from schedules with high DR_{daily} , showed increasing incidence of splits, with the exception of lumber from the *DS-3* with endless screws, for which incidence was similar to that present in *DS-standard* (Figure 2f). Where the endless screw system was employed to lessen the amount of defects, there was a slight increase in split incidence for *DS-2*, yet for *DS-3* it decreased (Figure 2f). After the drying this value increased where no screws system was employed (Figure 3b). Evaluation of quality by means of the IQ_{after} showed that those schedules with high DR_{daily} for reduction of drying time (*DR-2* and *DR-3*) and the use of screws decreased the IQ_{after} value (Figure 3b). Moreover, it was observed that the IQ_{after} values for dried-lumber are lower in the schedule with the greatest DR_{daily} (*DS-3*) in comparison with *DS-2* (Figure 3b), which exhibits lower DR_{daily} value.

Drying tensions: Presence of drying tensions is reduced by employing drying schedules intended to decrease the drying time, whether using or not a system of screws to avoid defects (Figure 4). When employing *DS-standard*, approximately 55-57% of the dried-lumber showed tensions catalogued as “moderate” immediately after drying (Figure 4a) or 24 hours after its termination (Figure 4b). On the other hand, in lumber dried with high DR_{daily} values to decrease its drying time, the amount of lumber classified as “low tension” increased for both periods evaluated (Figure 4). When evaluating lumber from *DS-2* immediately after drying, a greater percentage of lumber classified as “low tension” appeared in relation to lumber dried with *DS-3* (Figure 4a); however, 24 hours after the drying finished, the percentage of incidence is similar between both schedules in the different categories of quality for the drying tensions (Figure 4b). The evaluation of the utilization of endless screws showed that this system produced a slight decrease in the percentage of lumber classified as “low tension”, thus increasing the percentage of “moderate tension” lumber in both drying schedules and both drying periods (Figure 4).

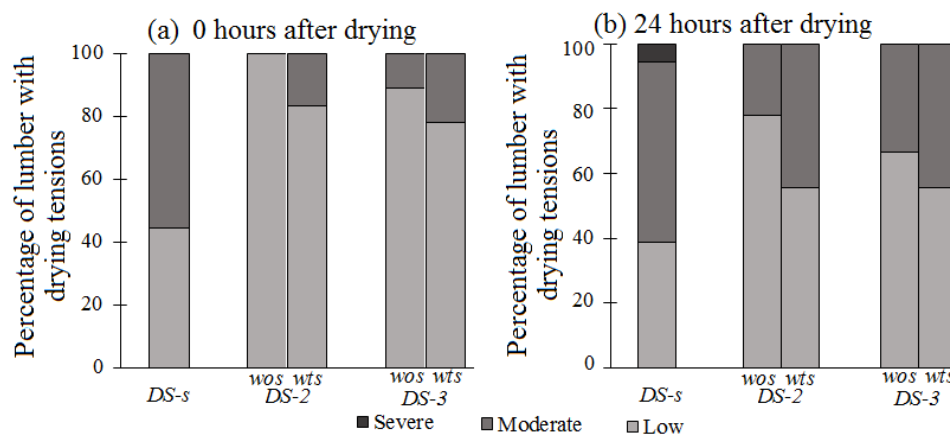

Figure 4. Drying tensions in dried-lumber at 0 hours (a) and 24 hours (b) after termination of drying for different drying schedules used for increasing daily drying rate and decreasing drying time of *Tectona grandis* wood.

Legend: DS-s: Drying Schedule standard; DS-2: Drying Schedule 2; DS-3: Drying Schedule 3; wos: without endless screws; wts: with endless screws.

Evaluation of colour: After drying, teak wood colour parameters of redness (a^* parameter) and yellowness (b^* parameter) increase their value significantly in relation to lumber before drying in the standard schedule (*DS-standard*) as well as in the different schedules employed to increase the DR_{daily} (*DS-2* and *DS-3*) and thus reduce drying time (Table 4). The colour parameter of luminosity (L^* parameter), on the other hand, increased only slightly in dried-lumber from *DS-standard* and *DS-2* without endless screws, whilst in dried-lumber from *DS-2* with endless screws and *DS-3* luminosity was not significantly altered (Table 4).

In the colour evaluation by means of the differential of colour ΔE^* (Equation 2), a slight increase in colour change was found (Table 4) in lumber dried with high DR_{daily} drying schedules for reduction of drying time. However, this change in the colour parameter is not statistically significant in *DS-2* with endless screws nor in *DS-3* without endless screws. Meanwhile, colour change was statistically significant in the other two drying schedules implemented for reducing the drying time (*DS-2* without endless screws and *DS-3* with endless screws) (Table 4).

Table 4. $L^*a^*b^*$ system colour parameters of *Tectona grandis* wood before and after drying with different drying schedules utilized for increasing daily drying rate and decreasing drying time of *Tectona grandis* wood.

Drying Schedule	Evaluation	L^*	a^*	b^*	Average of ΔE^*
<i>DS-standard</i>	before	61.5 (6.6) A	4.3 (28.4) A	23.3 (12.9) A	6.95A
	after	64.3 (6.6) B	6.3 (16.5) B	26.22(8.7) B	
<i>DS-2</i> without	before	64.0 (6.2) A	4.6 (34.7) A	24.0 (10.7) A	10.58C

endless screws	after	69.8 (8.7) B	8.0 (18.7) B	29.08 (9.2) B	
<i>DS-2</i> with	before	63.3 (6.5) A	3.8 (37.5) A	23.8 (10.7) A	7.67AB
endless screws	after	63.3 (8.4) A	8.5 (17.9) B	28.63 (9.3) B	
<i>DS-3</i> without	before	61.5 (9.3) A	6.6 (26.5) A	26.1 (9.0) A	7.68AB
endless screws	after	61.4 (8.6) A	8.8 (20.2) B	29.0 (8.4) B	
<i>DS-3</i> with	before	60.0 (11.5) A	6.2 (36.7) A	23.1 (12.5) A	8.90B
endless screws	After	57.7 (15.3) A	9.6 (18.1) B	26.1 (14.1) B	

Legend: *DS*: Drying Schedule. Different letters indicate statistical significances at 99%. The values in parentheses represent the coefficient of variation.

Discussion

Drying time is related to drying rate (Tenorio *et al.*, 2015) and this became manifest in the present study, where a lower drying time is obtained when drying schedules of high drying rates are implemented, as was the case with *DS-2* and *DS-3* (Table 2). Drying rates were, on average, from 1.16% to 2.09% hour⁻¹ (*DS-2* with endless screws and *DS-3* without endless screws, respectively) and these values are greater than those reported for other tropical climate species from forest plantations (Moya *et al.*, 2013).

Compared to the drying rates reported by Salas and Moya (2014), which are lower than 1% hour⁻¹, the drying rate obtained for teak wood in this study is greater, between 1.19% and 2.09% hour⁻¹. This difference may be due to the age of the trees used: Salas and Moya (2014) worked with lumber from a 14-year-old plantation, while the wood used for this study was 11 years old. A higher content of heartwood is present at an older age (Moya *et al.*, 2014) and this type of wood shows less permeability for the water displacement inside the wood (Ahmend & Chun, 2011).

Moreover, another important aspect to highlight regarding the drying times, especially for schedules with high DR_{daily} , is that teak lumber was dried in 4 days. This time is very similar to the one achieved in *Pinus radiata* (Ananias *et al.*, 2012), one of the species with the fastest kiln drying, which is highly commercialised worldwide.

Variation of MC_i values in *T. grandis* lumber before drying (extreme values from 85% to 114.7% and a CV from 14.3% to 19.31%) are superior to those reported by Salas and Moya (2014), who indicate values ranging from 57% to 109% and a CV from 5% up to 26%. Regarding MC_f , where schedules of high DR_{daily} were implemented for reduction of drying time (*DS-2* and *DS-3*), the value obtained is close to the target moisture content of 12% established, while the coefficient of variation for the value remains low (Table 2). This condition is an advantage, as it confirms that use of such schedules does not alter uniformity of the MC_f of dried-lumber.

In relation to quality of the lumber, as in this study lumber was obtained from fast-growth trees, specifically from trees of less than 11 years old, it presents a high percentage of juvenile wood (Moya *et al.*, 2014) as well

as high levels of growth stresses (Solórzano *et al.*, 2012). Green lumber from *T. grandis* species exhibited some warps (crooks and bows), splits, and checks (Figure 2a, 2-f). It was confirmed in the present study that cup defects do not generally appear in the green lumber from forest plantations, although they increase after drying (Figure 2d) (Tenorio *et al.*, 2012 and 2015; Moya *et al.*, 2013).

The increase of incidence of drying defects after kiln drying, especially of twist, cup, check and split defects (Figure 2a, 2-f), could again be related to the presence of juvenile wood, since this type of abnormal wood is known to produce distortions in dried-lumber due to a higher longitudinal shrinkage than normal wood (Zobel & Sprague, 2012). However, drying stresses that occur during lumber drying can also produce distortion (Straže *et al.*, 2011).

The incidence and magnitude of defects found in dried-lumber are consistent with studies performed by Moya *et al.* (2013) and Salas and Moya (2014), who found that the incidence of twist, cup, check and split defects increased while crook and bow defects decreased; similar results to those found in this study (Figure 2b and 2c).

The use of higher temperature values and lower equilibrium moisture content values in the drying programs used to decrease drying time, like those present in *DS-3*, decreases quality as it increases the incidence of twist, crook, bow, check and split defects (Figure 2a-c, 2e-f; Figure 3a-b), with the exception of the cup defect (Figure 2d). This increment occurs because the higher temperature causes greater moisture gradients that produce internal stresses inside the lumber that lead to failure, as is the case with checks, splits, or the tendency to warp, attributed to higher moisture content gradients (Olten *et al.*, 2007).

Nonetheless, the use of loads at the upper part of the pile or maintaining it held together to avoid movement have a positive influence when applied on wood above the fibre saturation point, in combination with high temperatures, with the purpose of counteracting the increase in drying defects such as checks and splits, owed to such temperatures (Vansteenkiste *et al.*, 1997). This improvement of the drying quality by using endless screws on the teak wood is not adequately reflected in the incidence of each defect, since the behaviour was irregular: incidence increased for some defects and decreased for others (Figure 2b). However, the quality of drying was evident in the IQ_{after} value, as for most defects this value decreased; therefore an increase in quality of the dried-lumber was observed (Figure 3a-b). Reduction of these defects as a result of using screws is explained by the fact that the forces to maintain the pile pressed work in a direction tangential to the growth rings, thereby reducing the development of internal checking. Besides, this force can be viewed as a counteracting force for stresses developed during drying or as a restraining force to internal stresses in the wood that give it a great tendency to accumulate drying defects (Simpson, 200).

Stresses in lumber are caused by the gradient or differential of moisture content established between the interior and the outermost layer of the wood sample (Vansteenkiste *et al.*, 1997) and also because the outer

layer of wood reaches fibre saturation point faster, generating stress between the interior and exterior (Passarini *et al.*, 2015). One advantage derived from the use of drying schedules with a high DR_{daily} for reduction of drying time ($DS-2$ and $DS-3$), in both high- DR_{daily} conditions, is that the percentage of dried-lumber with “low drying tensions” is greater than the percentage obtained with the $DS\text{-standard}$ at both of the stress measurement points (Figure 4).

It is important to note that the use of endless screws for daily adjustment during drying produces a lower percentage of dried-lumber catalogued as “low drying tension” in relation to the lack of such screws on the pile of lumber (Figure 4). This result, together with the evaluation of defects, indicates that when drying schedules with a high DR_{daily} are implemented to decrease drying time and endless screws are placed on the pile for daily adjustment, the incidence of warps, checks and splits is lessened (Figure 3).

Colour parameters in green lumber as well as in dried-lumber for this study (Table 4) are similar to results obtained for *T. grandis* wood from plantations in several locations of Costa Rica (Salas & Moya, 2014; Berrocal *et al.*, 2016b).

An advantage of implementing drying schedules with high temperatures in order to attain a high DR_{daily} , is that it allows for an increase of a^* and b^* parameters (Table 4), which are more related to darker coloration of wood and thus result in darker dried-lumber (greater ΔE^*) than when implementing $DS\text{-standard}$. A darker tone in *T. grandis* lumber is closer to that of wood grown in natural conditions (Moya *et al.* 2014).

Conclusions

The drying time, the lowest time (88 hours) was obtained in $DS-3$ without endless screws, while $DS-2$ treatment with endless screws (142 hours) rendered the longest drying time. And MC_f varied a maximum of 2% in relation to the objective value established for the five treatments. With regards to lumber quality, expressed in terms of the ratio of defects after drying, it was observed that the amount of lumber showing twist, bow, cup, check and split defects increased, whereas the percentage of crooks decreased; however, applying the index of quality, it was determined that most of the drying schedules are considered “excellent” or “very good”. Concerning colour change from before to after the treatment, no differences were found between $DS\text{-standard}$ and $DS-2$ or $DS-3$.

Finally, the best drying treatment for juvenile *T. grandis* lumber, taking as reference the drying rate, colour change, index of quality for drying defects (“very good” and “excellent”) and drying stresses (low to moderate) , would be the $DS-3$ without endless screws.

Acknowledgments

The authors wish to thank the *Vicerrectoría de Investigación y Extensión* at the *Instituto Tecnológico de Costa Rica (ITCR)*, and *Life Forestry Costa Rica S.A.* for providing the raw material and other help for the study.

References

- AHMED SA & CHUN S K. 2011. PERMEABILITY OF TECTONA GRANDIS L. AS AFFECTED BY WOOD STRUCTURE. WOOD SCIENCE AND TECHNOLOGY 45(3): 487-500.
- ANANÍAS RA, ULLOA J, ELUSTONDO DM, SALINAS C, REBOLLEDO P & FUENTES C. 2012. ENERGY CONSUMPTION IN INDUSTRIAL DRYING OF RADIATA PINE. DRYING TECHNOLOGY 30(7): 774-779.
- ASTM (AMERICAN SOCIETY FOR TESTING AND MATERIALS). 2014. STANDARD PRACTICE FOR CALCULATION OF COLOR TOLERANCES AND COLOR DIFFERENCES FROM INSTRUMENTALLY MEASURED COLOR COORDINATES. D-2244-11. ASTM INTERNATIONAL, WEST CONSHOHOCKEN, PA.
- ASTM (AMERICAN SOCIETY FOR TESTING AND MATERIALS). 2012A. STANDARD TEST METHODS FOR DIRECT MOISTURE CONTENT MEASUREMENT OF WOOD AND WOOD-BASE MATERIALS. D-4422-07. ASTM INTERNATIONAL, WEST CONSHOHOCKEN, PA.
- BERROCAL A, MOYA R, RODRÍGUEZ-SOLÍS M, STARBID R & MUÑOZ F. 2016A. SURFACE CHEMICAL AND COLOUR CHARACTERIZATION OF JUVENILE TECTONA GRANDIS WOOD SUBJECTED TO STEAM-DRYING TREATMENTS: EFFECT OF GRAIN PATTERN AND MOISTURE CONTENT. SURFACE REVIEW AND LETTERS (ACCEPTED). DOI: 10.1142/S0218625X15500912
- BERROCAL A, MOYA R, BOND B, RODRÍGUEZ-SOLÍS M & MUÑOZ F. 2016B. DECREASE IN KILN DRYING TIME OF JUVENILE TECTONA GRANDIS L. WOOD USING DRYING RATE. WOOD FIBER AND SCIENCE (SUBMITTED)
- CARLSSON P & ARFVIDSSON J. 2007. OPTIMIZED WOOD DRYING. DRYING TECHNOLOGY 18: 1779–1796.
- DENIG J, WENGERT EM & SIMPSON WT. 2000. DRYING HARDWOOD LUMBER. USDA (UNITED STATES DEPARTMENT OF AGRICULTURE). FOREST PRODUCTS LABORATORY USA 138PP.
- KORKUT S & GULLER B. 2007. COMPARISON OF TWO DRYING SCHEDULES FOR EUROPEAN HOPHORNBEAM (OSTRYA CARPINIFOLIA SCOP.) LUMBER. DRYING TECHNOLOGY 25(12): 1977-1984.
- MOYA R, BOND B & QUESADA-PINEDA H. 2014. A review of heartwood properties of *Tectona grandis* trees from fast-growth plantations. *Wood Science and Technology* 48(2): 411-433.
- MOYA R, UREÑA E, SALAS C, MUÑOZ F & ESPINOZA O. 2013. Kiln drying behaviour of lumber from ten fast-growth plantation species in Costa Rica. *Wood Material Science & Engineering* 8(1): 37-45.
- OLTEAN L, TEISCHINGER A & HANSMANN C. 2007. INFLUENCE OF TEMPERATURE ON CRACKING AND MECHANICAL PROPERTIES OF WOOD DURING WOOD DRYING-REVIEW. BIORESOURCES 2(4): 789-811.

PASSARINI L, MALVEAU C & HERNÁNDEZ RE. 2015. DISTRIBUTION OF THE EQUILIBRIUM MOISTURE CONTENT IN FOUR HARDWOODS BELOW FIBER SATURATION POINT WITH MAGNETIC RESONANCE MICROIMAGING. *WOOD SCIENCE AND TECHNOLOGY* 1-18. 10.1007/s00226-015-0751-7

PÉREZ P, ANANIAS RA & HERNANDEZ G. 2007. ESTUDIO EXPERIMENTAL DEL SECADO DE RENOVALES DE CANELO DRIMYS WINTERI. *MADERAS CIENCIA Y TECNOLOGÍA* 9: 59–70.

SALAS C & MOYA R. 2014. KILN-, SOLAR-, AND AIR-DRYING BEHAVIOR OF LUMBER OF *TECTONA GRANDIS* AND *GMELINA ARBOREA* FROM FAST-GROWN PLANTATIONS: MOISTURE CONTENT, WOOD COLOR, AND DRYING DEFECTS. *DRYING TECHNOLOGY: AN INTERNATIONAL JOURNAL* 32(3): 301-310.

STRAŽE A, KLIGER R, JOHANSSON M & GORIŠEK Ž. 2011. THE INFLUENCE OF MATERIAL PROPERTIES ON THE AMOUNT OF TWIST OF SPRUCE WOOD DURING KILN DRYING. *EUROPEAN JOURNAL OF WOOD AND WOOD PRODUCTS* 69(2): 239-246

SYDNEY R, CHARLES J, KOZLIK P, BOIS J & WENGERT E. 1988. DRY KILN SCHEDULES FOR COMMERCIAL WOODS: TEMPERATE AND TROPICAL. US FOREST SERVICE FOREST PRODUCTS LABORATORY: MADISON, WI 158, 1988. GENERAL TECHNICAL REPORT FPL-GTR-57.

SOLÓRZANO S, MOYA R & MURILLO O. 2012. EARLY PREDICTION OF BASIC DENSITY, SHRINKING, PRESENCE OF GROWTH STRESS, AND DYNAMIC ELASTIC MODULUS BASED ON THE MORPHOLOGICAL TREE PARAMETERS OF *TECTONA GRANDIS*. *JOURNAL OF WOOD SCIENCE* 58(4): 290-299.

TENORIO C, MOYA R & QUESADA-PINEDA H. 2012. KILN DRYING OF *ACACIA MANGIUM* WOOD: COLOUR, SHRINKAGE, WARP, SPLIT AND CHECK IN LUMBER BEFORE AND AFTER DRYING. *JOURNAL OF TROPICAL FOREST SCIENCE* 24 (1): 125-139.

TENORIO C, MOYA R & SALAS C. 2015. KILN DRYING BEHAVIOUR UTILIZING DRYING RATE OF LUMBER FROM SIX FAST-GROWTH PLANTATION SPECIES IN COSTA RICA. *DRYING TECHNOLOGY* (ACCEPT).

VANSTEENKISTE D, STEVENS M & VAN ACKER J. 1997. HIGH TEMPERATURE DRYING OF FRESH SAWN POPLAR WOOD IN AN EXPERIMENTAL CONVECTIVE DRYER. *HOLZ ALS ROH-UND WERKSTOFF* 35: 307-334.

ZOBEL BJ & SPRAGUE JR. 2012. *JUVENILE WOOD IN FOREST TREES*. SPRINGER VERLAG, NEW YORK, USA.

3. Artículo 3. Surface chemical and color characterization of juvenile *Tectona grandis* wood subjected to steam-drying treatments.

November 5, 2015 12:15:29pm WSPC/149-SRL 1550091 ISSN: 0218-625X

2nd Reading

Surface Review and Letters, Vol. 23, No. 1 (2016) 1550091 (14 pages)
 © World Scientific Publishing Company
 DOI: 10.1142/S0218625X15500912



SURFACE CHEMICAL AND COLOR CHARACTERIZATION OF JUVENILE *TECTONA GRANDIS* WOOD SUBJECTED TO STEAM-DRYING TREATMENTS

ALEXANDER BERROCAL*, RÓGER MOYA†
 and MARÍA RODRIGUEZ-SOLIS‡
*Escuela de Ingeniería Forestal
 Instituto Tecnológico de Costa Rica
 Apartado 159-7050, Cartago, Costa Rica*
 *aberrocal@itcr.ac.cr
 †rmoya@itcr.ac.cr
 ‡maria.rodriguez@itcr.ac.cr

RICARDO STARBIRD
*Escuela de Química, Instituto Tecnológico de Costa Rica
 Apartado 159-7050, Cartago, Costa Rica*
 rstarbird@itcr.ac.cr

FREDDY MUÑOZ
*Escuela de Ingeniería Forestal
 Instituto Tecnológico de Costa Rica
 Apartado 159-7050, Cartago, Costa Rica*
 fmunoz@itcr.ac.cr

Received 4 June 2015
 Revised 22 September 2015
 Accepted 23 September 2015
 Published

The color of *Tectona grandis* wood is an attribute that favors its commercialization, however, wood color from fast-growth plantation trees is clear and lacks uniformity. The aim of this work is to characterize steamed teak wood by means of the Fourier transform infrared spectroscopy (FTIR) and $L^*a^*b^*$ color systems. Two moisture conditions (green and 50%) and two grain patterns (flat and quarter) of boards were analyzed through the application of different steaming times (0, 3, 6, 9, 12, 15 and 18 h). The FTIR results showed that the bands at 1158, 1231, 1373 and 1419 cm^{-1} did not show any change with steaming, whereas the bands at 1053, 1108, 1453, 1506, 1536, 1558, 1595, 1652, 1683, 1700 and 1733 cm^{-1} presented a decrease in the intensity with the steaming time. The band at 1318 cm^{-1} was the only one that increased. Lightness (L^*) was the most affected parameter, followed by yellowness (b^*), while redness (a^*) showed the smallest change. Surface color change (ΔE^*) presented the lowest value between 3 h and 6 h of steam-drying in the boards with flat grain, whereas for boards with quarter grain, the smallest ΔE^* value was obtained after 18 h of steaming.

Keywords: Wood treatment; steam-drying treatment; surface analysis; tropical wood; color uniformity.

†Corresponding author.

A. Berrocal *et al.*

1. Introduction

Tectona grandis L.f. has been largely planted in many tropical regions, including Latin America, Asia, Africa and Oceania, covering approximately 6 million ha.¹ Thanks to its physical, mechanical and aesthetic properties, the wood of this tropical species has become one of the most important in international markets.²

Additionally, teak wood color is considered a major attribute regarding commercialization.³ Thulasidas *et al.*⁴ indicated that teak wood is a premier hardwood valued for the attractiveness of its golden yellow or brown color.

Teak color has been widely studied in the past few years.² The color of the wood from trees grown in plantations is lighter than the color of the wood from natural forests.^{5,6} For this reason, the price of the wood from trees from short-rotation plantations is lower in the timber market.⁴

In addition to its lighter color, the great variability of the heartwood color of teak wood is another inconvenience.^{3,7} For example, Moya and Berrocal⁷ found approximately 15% variation in the wood color parameters (lightness (L^*), redness (a^*) and yellowness (b^*)). Thulasidas *et al.*⁴ found a similar variation in wood from homegarden trees. Finally, Moya and Marin⁵ found 31–53% variation in the color parameters (L^* , a^* , b^*) in cloned trees.

There are various techniques to homogenize the color of the wood or to try to achieve more uniform darker colors.⁸ Steam-drying treatment has been known for a long time as one of the most effective methods to improve the dimensional stability, decay resistance and durability of wood, while simultaneously darkening the wood color.⁹ In terms of the mechanism for the dark color development, the properties and quantities of major chemicals and extractive compositions in wood are modified during the steam-heat treatment.⁹

Wood color can also be homogenized through drying. However, studies on how to obtain darker teak wood are still unfinished.² For example, in a first attempt, Berrocal and Agüero¹⁰ applied a system of preservation and coloring in order to homogenize the color of the sapwood and the heartwood. Salas and Moya,¹¹ meanwhile, found that lightness diminished while redness and yellowness increased after the process of wood drying with three different methods

(air, kiln and solar drying), thus resulting in darker wood.

Other forms of changing the color of teak wood have been implemented which focus on growing trees. They are focused on when the trees are growing. Recently, Moya and Marin⁵ proposed the genetic selection of trees with similar color conditions to that of trees growing in plantation conditions, in order to achieve darker and less variable improved teak wood.

The color change produced by steaming or drying is caused by chemical changes in the wood surface. The Fourier transform infrared spectroscopy (FTIR) has made it possible to perceive those changes. Specifically, changes occurring in the 800–1800 cm^{-1} band are being studied.¹² Huang *et al.*¹³ and Lionetto *et al.*¹⁴ have shown that employing the ratio I_{1316}/I_{1336} provides information concerning the process of degradation of the amorphous and crystalline cellulose zones during the steaming. Moreover, changes due to steaming at peaks at 1738, 1596 and 810 cm^{-1} show alterations in the wood hemicellulose and lignin.^{12,15}

Although efforts have been made to standardize the color of teak wood from plantation trees, little research has been conducted as to the changes produced by steaming in combination with drying on the wood of trees from fast-growth plantations. Therefore, the aim of the present study is to establish the changes of color (measured by $L^*a^*b^*$ color systems) as well as the chemical changes (by FTIR measurements) occurring in the wood surface, using various steaming times (0, 3, 6, 9, 12, 15 and 18 h) in flat and quarter pattern boards in two conditions of moisture content (MC): green and 50%. This work will allow to establish the best conditions regarding steaming time and MC of *Tectona grandis* with different grain patterns.

2. Materials and Methods

2.1. Provenance of the wood, sampling and moisture condition

For the present study, 11-year-old trees from a second thinning intervention in a plantation owned by Aserradero S&Q, located in Rincón de Osa in the province of Puntarenas, Costa Rica (8°40'38" N; 83°29'43" W), were used. *Tectona grandis* 11 years old with 3 × 3 m spacing (1100 trees·ha⁻¹). Stand

Surface Chemical and Color Characterization of Steam-Dried *Tectona grandis* Wood

Fig. 1. (a) Pilot steaming chamber utilized and (b) intensity at 1031 cm⁻¹ band at different steaming times in *Tectona grandis* wood with flat pattern and quarter pattern with different steaming times.

density was 475 trees · ha⁻¹, with an average diameter at breast height (DBH) of 23 cm and 14 m height. The heartwood percentage at DBH varied from 65% to 80%. Approximately, four 2.5 m long logs were extracted from the selected trees. Nine trees were selected from plantation because this number of trees are typically used for determining wood properties.¹³

The logs were sawn using a grain pattern to produce 25-mm-thick boards, allowing for flat-grain- and quarter-grain-patterned boards. About 120 boards were selected, out of which 60 were flat-grain- and the remaining 60 were quarter-grain-patterned. The boards from each grain pattern were then separated into two groups of 30 boards each. One group patterned green condition — was stored to retain the moisture. A second group was air-dried to reach 50% MC. Once both conditions of MC were reached, seven test samples approximately 2.5 cm in width and 35 cm long were extracted from each one of the boards.

2.2. Steam-drying treatment

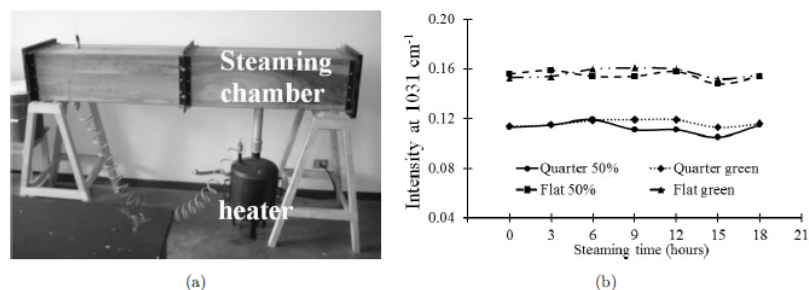
For each steam-drying test with water, 30 test samples of each grain pattern and moisture condition were used (7 steaming times × 2 grain patterns × 2 moisture conditions × 30 samples = 840 samples). A steam pilot wooden chamber (200 cm × 30 cm × 30 cm) was used (Fig. 1) and the steam was provided by a 19-l water-heating tank. An electric resistance was employed to boil the water (Fig. 1).

Steam-drying treatments are described in Table 1; about seven different treatments were applied. For each grain pattern and for each moisture condition, four different baths were conducted. The treatments consist of one control sample and six treatments including steaming of the wood in six different drying times, with a difference of 3 h between them (Table 1). First, water steam was added into the chamber for a conditioning period of 3 h during which the chamber reaches approximately 70°C. The wood to be steam-dried is separated into each grain pattern and moisture condition in seven packages of 30

Table 1. Description of the steam-drying treatments applied to *Tectona grandis* wood in plantations.

No.	Steaming time (h)	Descriptions
1.	0	Control treatment, 0 h steaming and samples dried to 12% MC.
2.	3	Wood was steamed for 3 h and dried to 12% MC.
3.	6	Wood was steamed for 6 h and dried to 12% MC.
4.	9	Wood was steamed for 9 h and dried to 12% MC.
5.	12	Wood was steamed for 12 h and dried to 12% MC.
6.	15	Wood was steamed for 15 h and dried to 12% MC.
7.	18	Wood was steamed for 18 h and dried to 12% MC.

Notes About 3 h of conditioning was applied in all treatments before initiating the steaming.

A. Berrocal et al.

Table 2. Summary of FTIR bands observed between 800 cm^{-1} and 1800 cm^{-1} in steam-treated *Tectona grandis* wood surface.

S. No.	Position (cm^{-1})	Peak assignments	Structural polymers
Peaks present in all <i>Tectona grandis</i> samples			
1.	810	C=O	Glucomanan
2.	1031	C-O stretch	Cellulose and hemicellulose
3.	1053	C-O stretch	Cellulose and hemicellulose
4.	1108	Aromatic skeletal and C-O stretch	Polysaccharides and lignin
5.	1158	C-O-C vibration	Cellulose and hemicellulose
6.	1231	C-O of syringyl ring	Lignin
7.	1318	C-O vibration	Lignin
8.	1373	C-H deformation	Cellulose and hemicellulose
9.	1419	C-H in-plane deformation with aromatic ring stretching	Lignin
10.	1453	CH deformation, asymmetry in CH_3 and CH_2	Cellulose
16.	1506	Aromatic skeletal vibration (C=C)	Lignin
19.	1595	Aromatic skeletal vibration (C=C)	Lignin
24.	1652	Conjugated C=O in quinones coupled with C=O stretching of various groups	Hemicellulose
25.	1717	C=O stretching	In the carboxylic acid in lignin
26.	1733	Conjugated C=O	Xylan in hemicelluloses
Peaks present in all quarter <i>Tectona grandis</i> wood samples			
	1616	Aromatic skeletal vibration (C=C)	Tannin
	1635	Aromatic skeletal vibration (C=C)	Tannin
	1675	C=O stretching in conjugated aromatic	Lignin

Source: Li et al.¹⁸ and Bonifazi et al.²³

boards each. The control package is left without steam and the other six packages are introduced into the chamber once it has been conditioned and steaming continues. Every 3 h, one package is taken out of the chamber and the wood is dried to reach 12% MC. The steaming time was selected according to previous research in tropical species.¹⁶

2.3. Measurement and analysis of the FTIR spectra of the surface of the wood

Once the steam-drying treatment with different times (0, 3, 6, 9, 12, 15 and 18 h) is finished for each grain pattern, three different boards were taken randomly from each time and grain pattern and two small samples were extracted from the surface of the board. Their dimensions (width \times length \times thickness) were $1\text{ cm} \times 1\text{ cm} \times 2 \times 1\text{ mm}$ (this part is in the surface of the board). The FTIR spectra of the three samples were measured on the surface of the wood by means of a Nicolet 380 FTIR spectrometer (Thermo Scientific) using a single reflectance ATR cell (equipped with a

diamond crystal). All data were recorded at room temperature, in the spectral range of $4000\text{--}700\text{ cm}^{-1}$, by accumulating 64 scans with a resolution of 1 cm^{-1} .

The FTIR spectra obtained were then processed by the softwares Spotlight 1.5.1, Hyperview 3.2 and Spectrum 6.2.0 developed by Perkin Elmer, Inc. Baseline correction was applied at $1800\text{--}800\text{ cm}^{-1}$ and the main components in this vibration band were identified. This band was selected as several studies have identified it as the range where the variation in the changes of the surface of the wood mostly occurs,^{17,18} which are described in Table 2. The height of each peak for each steaming time was recorded and standardized taking the I_{1031} band as a reference, given its stability in all the conditions studied. The ratio between the various peaks in the range of $800\text{--}1800\text{ cm}^{-1}$ (Eq. (1)) was then calculated, as well as the band at 1031 cm^{-1} (1) all times and different grain patterns. This band was selected because large differences were not observed among treatments. The intensity was 0.155 cm^{-1} in wood with flat pattern and 0.118 cm^{-1} in wood with radial pattern with different steaming times (Fig. 1(b)).

$$\begin{aligned} \text{Ratio of intensity } (I_n/T_{1031}) \\ = \frac{\text{Intensity of peaks between } 1800 \text{ to } 800 \text{ cm}^{-1}}{\text{Intensity of } 1031 \text{ cm}^{-1}}. \end{aligned} \quad (1)$$

2.4. Surface color measurement and determination of color change

For all conditions of MC and grain pattern, color was evaluated before the steam-drying treatment. Wood surface color was also determined after each steam-drying treatment once the wood reached approximately 12% MC. The MiniScan XE Plus¹⁹ spectrophotometer was utilized to obtain the values of the standardized chromatological system CIEL*a*b*. The range for this measure is from 400 nm to 700 nm, with 11 mm opening at the point of measurement. The observation of the reflection included the specular component (SCI mode), at an angle of 10°, which is normal for the surface of the specimen (D65/10); a visual range of 2° (Standard observer, CIE 1931) and an illumination standard of D65 (corresponding to daylight at 6500 K).

In the analysis of color change, the change in the color parameters (L^* , a^* , b^*) was calculated first with the aid of Eq. (2).

$$\Delta P = P_b - P_a, \quad (2)$$

where ΔP = represents the absolute value of wood color parameters (L^* , a^* or b^*) change between after and before steaming process. P_b is the wood color parameters (L^* , a^* or b^*) after the steam-drying treatment and P_a is the wood color parameters (L^* , a^* or b^*) before the steam-drying treatment.

Following, color change was determined, utilizing the parameter ΔE^* calculated according to the ASTM D 2244 standard²⁰ whose formula is detailed in Eq. (3). The color difference (ΔE^*) was determined for (i) color change that occurred in the wood surface, taking the color before steam-drying treatment as a model, (ii) color change after the steam-drying treatment and (iii) the surface color of wood coming from the natural forest and mature trees,⁵ aimed at establishing the treatment with the lowest color difference with respect to commonly commercialized wood of natural forests (over 100-year-old).

$$\Delta E^* = \sqrt{(\Delta L^*)^2 + (\Delta a^*)^2 + (\Delta b^*)^2}, \quad (3)$$

where ΔE^* = wood color difference, $\Delta L = L^*$ before steaming $-L^*$ after steaming; $\Delta a = a^*$ before steaming $-a^*$ after steaming and $\Delta b = b^*$ before steaming $-b^*$ after steaming. For color change in (ii), the values of L^* , a^* and b^* after steaming were substituted by $L^* = 44.94$, $a^* = 12.44$ and $b^* = 24.26$, which correspond to the color parameters measured in the wood coming from the natural forest.

2.5. Statistical analysis

In each grain pattern (flat or quarter pattern), a variance analysis (ANOVA) was applied. The aim was to know whether differences in the parameter before and after steam-drying treatment exist. The model included the following sources of variation: steaming time (t) at seven levels (0, 3, 6, 9, 12, 15 and 18 h), MC at two levels (green and 50%) and interaction between t and MC. The SAS GLM procedure (SAS Institute, Inc.) was used to conduct the analysis of variance.

In addition, a *forward stepwise* analysis was applied to determine the effects of the three color parameters Δa^* , Δb^* and ΔL^* on the teak wood color before and after steam-drying treatment, with wood from natural forests as a model. For the FTIR spectra, a scatter plot and then regression analysis were conducted taking into account the steaming time (x-axis) and the intensity ratio values (y-axis). The change in the intensity ratio peak assignment was thus observed for the different steaming times.

3. Results and Discussion

3.1. Surface chemistry of steamed *Tectona grandis* wood measured by means of the FTIR spectra

Although the entire range of the spectra (4000–400 cm^{-1}) was not presented, signals were present in all the steaming periods and grain patterns in the region 3500–2500 cm^{-1} , corresponding to stretching of O-H group (close to 3400 cm^{-1}), C-H and CH_2 asymmetric and symmetric stretching (2940 cm^{-1} and 2906 cm^{-1} , respectively) of the combination of cellulose, hemicelluloses and lignin.^{21,22}

A. Berrocal *et al.*

Peak assignments varied slightly in each type of wood (flat or quarter grain) and MC (green and 50%) in the band studied (1000–1800 cm^{-1}). Table 2 summarizes in its first part the common peaks for different types of wood treatment and presents the peak assignments, as well as to which polymer they are assigned, based on reports from Moore and Owen,²¹ Li *et al.*¹⁸ and Bonifazi *et al.*²³

The infrared spectra of the different treatments studied had revealed that the positions of most bands and their intensities in the fingerprint region are similar while some are slightly different (Fig. 2). It was found that the chemical components with the signal at 810, 1035, 1053, 1108, 1158, 1231, 1318, 1373 (C–H in-plane deformation for polysaccharides), 1419 (C–H in-plane deformation), 1453 (C–H deformation and aromatic skeletal vibrations), 1506 (aromatic skeletal vibrations), 1558, 1595 (aromatic skeletal vibrations), 1652 (conjugated carbonyl), 1683, 1700, 1717 and 1733 cm^{-1} (stretching of the carbonyl group C=O) are present in all surfaces in the different treatments (Figs. 2(a) and 2(b)), while chemical components with the signal at 1540, 1554, 1575, 1616, 1635, 1675 and 1695 cm^{-1} were observed in the FTIR spectra of the radial samples when the wood was not steam-treated (Figs. 2(c) and 2(d)).

As for the variation of the intensity ratio for each one of the peaks within the band of 800–1800 cm^{-1} , it was observed that the signal at 1158, 1231, 1373 and 1419 cm^{-1} did not show any trend in the index, due to the treatment of the wood with different steaming times and grain patterns of the boards. Meanwhile, the signals at 1053, 1108, 1453, 1506, 1536, 1558, 1595, 1652, 1683, 1700 and 1733 cm^{-1} showed diminution of the index of vibration regarding the steaming time (Figs. 3(a), 3(b) and 3(d)–3(l)). The only vibration where the index augmented was 1318 cm^{-1} (Fig. 3(c)). In the same way, the variation coefficient varied from 10% to 22% at different intensities (Table 3) and any tendency was not found.

As for the signals at 1540, 1554, 1575, 1616, 1635, 1675 and 1695 cm^{-1} , present in the FTIR spectra of the quarter pattern samples of wood not treated with steam, they diminished or disappeared once the wood was steam-treated (Figs. 3(c) and 3(d)).

As for the bands associated to cellulose (1053, 1373, 1158 and 1453 cm^{-1}), a decrease in the signals in the band between 1053 cm^{-1} and 1453 cm^{-1} (Figs. 3(a) and 3(d)) was observed, while the signals

at 1318 cm^{-1} increased (Fig. 3(c)). Meanwhile, the signals 1373 and 1158 cm^{-1} did not show any modifications. The diminutions observed in the cellulose indicate either the occurrence of changes in its structure or the formation of other compounds, such as the formation of aliphatic alcohols during steaming,¹⁸ which becomes evident in the change of the intensity at 1055 cm^{-1} .

A major aspect to emphasize of the steaming process in *Tectona grandis* wood, is the variation in the intensity of the signals at 1053 cm^{-1} (Fig. 3(a)) and the increment in the intensity at 1318 cm^{-1} (Fig. 3(c)). These changes are designated to increase the glucose ring stretching vibration, and may be due to the cleavage and dehydration of amorphous carbohydrates and/or crystallization of the paracrystalline region of cellulose.¹⁴ The increment in the intensity ratio in the signal at 1318 cm^{-1} (Fig. 3(c)) indicates a decrease in the percentage of cellulose crystallinity.¹⁸ This reveals that the amorphous regions of the teak wood increase with the steaming time.¹⁴

The changes in the intensity of the signals associated with hemicelluloses and lignin — shown in peaks at 1733 cm^{-1} (O-acetyl-4-O-methylglucurono-xylan) (Fig. 3(l)), and 1595 cm^{-1} (belonging to C=O stretching vibrations in the carboxyl group of glucuronic acid unit in xylan) (Fig. 3(h)) — to the aromatic skeletal vibrations plus C–O stretch of lignin²⁴ and to vibrations caused by the equatorially aligned hydrogen at the C₂ atom in the mannose residue of glucomannan,¹⁵ clearly indicating the changes in the structure of the hemicelluloses and the structure of the lignin of teak wood as a result of steaming.

There is an important reference at 810 cm^{-1} intensity. Any signal was found in this intensity for quarter, flat or moisture conditions (Fig. 4). According to Guo *et al.*,¹² in softwood species, the 810 cm^{-1} , corespondent to C=O in the O=C–OH group of the glucuronic acid unit of the glucomannan band, decreased by 47% in steam wood. They affirmed that this chemical change might be related to the effect of the compression which presumably created more porous structures in earlywood due to the heavy distortion of the cell wall but caused a closure of lumens in latewood. Such pores, small cracks and more open lumens would facilitate penetration of steam, leading to higher degradation of hemicellulose structures in the earlywood.¹² However, this structural change was not found in *Tectona grandis*, showing with this

Surface Chemical and Color Characterization of Steam-Dried *Tectona grandis* Wood

Fig. 2. FTIR spectra of steamed *Tectona grandis* wood with flat pattern (a) and (b) and quarter pattern (c) and (d) with different steaming periods.

result the differences between softwood and hardwood species.

Nevertheless, those changes behaved differently with the steaming time and the grain pattern. For example, with the change of intensity at 1595 cm^{-1} (Fig. 3(h)), associated to lignin, the main change occurs at 3 h of steaming, with no more changes thereafter. On the other hand, regarding the intensity associated to xylan, an increment in the ratio I_{1733}/I_{1031} is observed with the steaming time (Fig. 3(l)), indicating further change in the structure of this hemicellulose due to the steaming process.

The intensity of vibration of the xylan band at 1453 cm^{-1} (Fig. 3(d)) ascribed to CH_2 symmetric bending on the xylose ring¹⁵ only showed small changes for the different steaming times. Because the 1456 cm^{-1} peak, associated to the xylan backbone, was nearly unaffected, it is probable that no major degradation of the xylan backbone had occurred, and that the primary effect on the xylan was a side group splitting.¹²

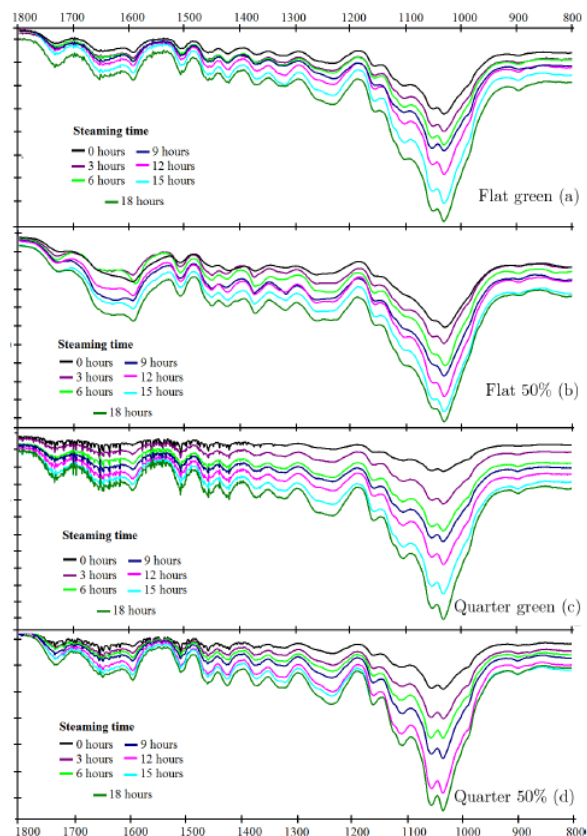
The larger decrease in the relative signal between 1596 cm^{-1} to 1733 cm^{-1} (Figs. 3(h)–3(l)), especially during the first 3 h of steaming of the flat pattern

A. Berrocal et al.

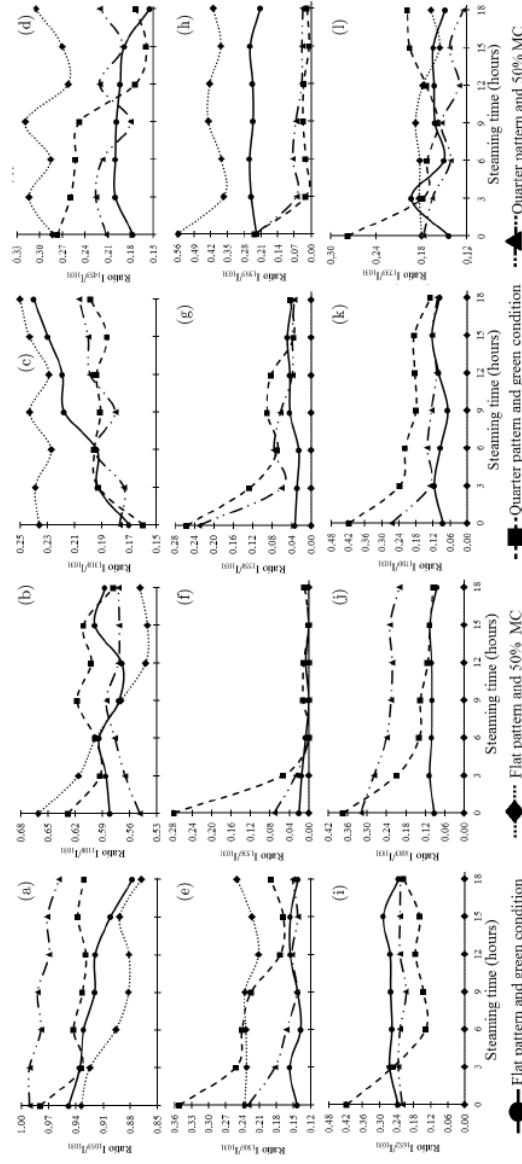

Fig. 3. Changes in the ratio of intensity (I_n/I_0) band at different steaming times in *Tectona grandis* wood with flat pattern and quarter pattern with different steaming times.

Surface Chemical and Color Characterization of Steam-Dried *Tectona grandis* WoodTable 3. Coefficient of variation (%) of change in the ratio of intensity ($I_u/T1031$) band at different steaming times in *Tectona grandis* wood with flat pattern and quarter pattern with different steaming times.

IT	TS(h)	Radial grain		Tangential grain		IT	TS(h)	Radial grain		Tangential grain	
		50%	Green	50%	Green			Green	50%	Green	50%
1053	0	16	23	21	17	1108	0	19	23	13	20
	3	15	14	14	19		3	15	16	15	20
	6	22	20	15	24		6	15	32	16	23
	9	19	29	15	22		9	12	30	13	22
	12	18	24	13	20		12	18	26	20	24
	15	9	18	14	31		15	12	19	19	35
1318	18	17	21	16	22	1453	18	12	23	23	21
	0	17	10	11	21		0	22	15	21	18
	3	23	13	15	15		3	21	17	21	20
	6	20	24	17	22		6	20	16	20	18
	9	20	21	17	18		9	16	17	18	19
	12	20	15	18	24		12	22	18	20	21
1506	15	18	15	13	21	1536	15	16	17	18	17
	18	18	14	14	21		18	18	21	22	20
	0	16	12	24	21		0	15	15	17	18
	3	12	19	19	20		3	21	15	16	16
	6	19	17	17	20		6	22	16	18	17
	9	16	22	26	23		9	19	14	20	20
1558	12	25	19	19	24	1595	12	16	17	15	13
	15	17	17	22	21		15	22	20	17	16
	18	14	25	24	21		18	19	19	12	14
	0	15	12	15	12		0	15	12	15	17
	3	13	11	15	10		3	10	15	17	19
	6	12	11	14	10		6	13	17	18	18
1652	9	11	11	12	13	1683	9	17	18	16	16
	12	14	13	15	11		12	14	11	16	13
	15	11	13	13	13		15	19	14	15	18
	18	11	12	13	9		18	21	12	16	17
	0	17	13	17	13		0	13	23	17	20
	3	16	12	19	17		3	16	18	18	20
1700	6	17	17	16	17	1703	6	17	18	18	20
	9	17	16	17	19		9	15	20	20	21
	12	14	11	15	19		12	19	22	22	20
	15	15	13	15	19		15	15	21	22	19
	18	18	12	15	16		18	15	21	19	19
	0	19	22	22	12		0	19	14	16	12
1700	3	15	19	23	14	1703	3	15	17	13	14
	6	14	19	20	12		6	14	13	17	12
	9	16	15	18	12		9	16	15	18	12
	12	13	21	23	11		12	13	13	13	14
	15	19	16	23	12		15	14	16	13	13
	18	14	22	15	14		18	14	13	15	13

Notes: IT: intensity; TS: time of steaming.

samples, and the steady diminution in quarter pattern samples (Fig. 3(h)), in combination with the lower change in intensity at 1506 cm^{-1} (Fig. 3(e)), indicate that a loss of the C=O group linked to the aromatic skeleton of lignin has probably occurred.

This could indicate that cross-links have been formed between aromatic units in the lignin. Obviously, different behaviors are observed for hemicelluloses and lignin in relation to the degradation under steam conditions. This points to the degradation of

A. Berrocal et al.

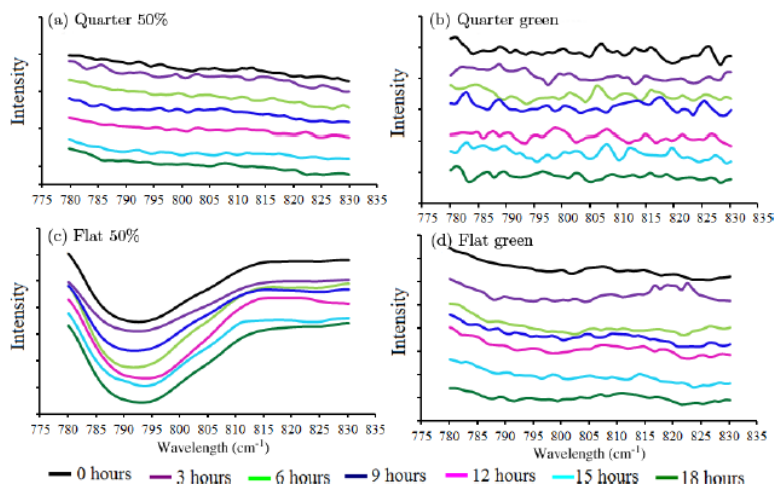

Fig. 4. FTIR spectra from 775 cm^{-1} to 835 cm^{-1} of steamed *Tectona grandis* wood with quarter pattern (a) and (b) and flat pattern (c) and (d) with different steaming periods.

hemicelluloses and lignin following different pathways. Lignin cross-linking is probably a radical reaction²⁵ which might be favored by the increased density of the wood material while the hemicellulose degradation is probably more favored by the more open access to dissolution of carbohydrates.²⁶

3.2. Color change in *Tectona grandis* surface wood induced by steaming and drying

Wood color before the steam-drying treatment showed differences by grain pattern and MC. Flat pattern boards in the two moisture conditions studied (green and 50%) presented lower values of lightness (L^*) and higher values of redness (a^*) relative to quarter pattern boards. As for yellowness (b^*), the color showed no difference between flat and quarter patterns before steaming (Table 4). Differences in color by grain pattern have been pointed out for several species.^{27,28}

The differences in the color parameters L^* and a^* and the lack of difference among parameter b^* , may be explained by two studies: (i) according to Gierlinger *et al.*,²⁹ redness (a^*) and lightness (L^*) indexes

are more correlated with wood extractive content, while the yellowness index is primarily related to the lignin's photochemistry; (ii) on the other hand, Valverde and Moya³⁰ mention that many extractives settle in the radial parenchyma cells, which means that in a radial surface, color will change more than that in a tangential surface. Therefore, L^* and a^* should be expected to change in green condition, since the extractives are exposed and the lignin still has not begun to photodegrade as the drying process has not started, which explains why the differences in b^* are not observed in flat and quarter pattern boards.

The magnitude of the color parameters changed in the different steaming–drying times (Table 4), L^* in particular, followed by b^* and, to a lesser extent, a^* . The steam-drying treatment increased lightness (L^*) significantly in flat and quarter grain green-condition boards (Table 4); however, when the board presents MC above 50%, the effect is the opposite, significantly reducing L^* .

This behavior is reflected in the differential values of luminosity (ΔL^*). ΔL^* values in flat and quarter pattern steam-dried woods were positive for wood in green condition, as opposed to 50% MC wood, where ΔL^* values were negative (Figs. 5(a) and 5(b)). No

Surface Chemical and Color Characterization of Steam-Dried *Tectona grandis* WoodTable 4. Lab system color parameters of *Tectona grandis* wood before and after the different steaming–drying times.

MC	Color parameters	Time	Steaming time (h)						
			0	3	6	9	12	15	18
			Flat pattern						
Green	L^*	Before	40.1A	41.5A	43.4A	43.7A	42.2A	41.2A	42.7A
		After	55.2B	53.9B	54.2B	53.5B	55.7B	55.5B	54.4B
	a^*	Before	11.7A	10.8A	10.4A	11.1A	11.3A	11.5A	11.1A
		After	11.0A	11.2A	10.4A	9.9A	10.3A	9.9B	9.6B
	b^*	Before	29.0A	28.4A	29.1A	28.9A	29.4A	28.3A	29.4A
		After	27.8A	25.4B	27.0B	26.2B	27.9A	26.5B	25.6B
50% MC	L^*	Before	56.5A	53.5A	54.9A	55.1A	55.4A	57.4A	55.8A
		After	51.2B	50.5B	50.4B	51.7B	51.4B	50.0B	50.2B
	a^*	Before	8.1A	8.0A	8.2A	7.8A	8.0A	7.4A	7.3A
		After	9.4B	9.6B	9.1A	9.4B	9.3B	8.4B	8.5A
	b^*	Before	22.9A	23.8A	25.6A	25.7A	27.6A	27.8A	27.7A
		After	23.8A	25.7B	26.3A	28.6B	29.0A	28.1A	28.4A
			Quarter pattern						
Green	L^*	Before	45.4A	46.6A	43.3A	45.2A	46.3A	45.2A	43.6A
		After	54.5B	57.3B	56.6B	57.5B	56.1B	55.1B	53.7B
	a^*	Before	9.1A	9.4A	10.3A	9.8A	9.2A	9.5A	10.4A
		After	8.7A	8.9A	9.4A	9.0A	8.6A	7.8B	7.6B
	b^*	Before	29.9A	29.4A	28.5A	29.1A	29.7A	29.1A	27.1A
		After	27.8B	27.5B	26.5B	28.1A	27.3B	25.3B	24.3B
50% MC	L^*	Before	61.3A	62.7A	62.5A	62.1A	62.5A	62.2A	61.5A
		After	60.2A	60.5B	60.2B	59.5B	57.5B	56.0B	54.4B
	a^*	Before	8.4A	8.1A	9.1A	9.0A	8.7A	8.5A	8.7A
		After	8.8A	8.3A	8.6A	8.8A	8.2A	8.0A	8.2A
	b^*	Before	27.8A	30.9A	27.8A	27.5A	26.8A	29.5A	29.1A
		After	29.2A	28.6A	28.3A	28.4A	26.6A	25.8B	24.5B

Notes: MC: moisture content.

defined behavior was observed in flat pattern among the different times (Fig. 5(a)). The lowest value of ΔL^* in flat pattern boards was observed during the 9 h of steam-drying and in the 3 h of steaming, for green-condition wood and 50% MC, respectively (Fig. 5(a)). For quarter pattern board, the ΔL^* values were not the lowest, after 12 h of steaming of the green-condition wood, while an increase in the steaming time in 50% MC wood was observed (Fig. 5(b)).

Meanwhile, the parameter of redness (a^*) was statistically unaffected in flat and quarter pattern boards in green condition between 0 h and 12 h of steaming–drying. Nevertheless, in the 15- and 18-h steaming treatment, the parameter a^* decreased significantly in both types of grain pattern (Table 4). This is reflected in the fact that the largest differential redness value (Δa^*) was observed at those steaming

times in the two types of grain pattern (Figs. 5(c) and 5(d)). Steam-drying results vary between flat and quarter patterns when the wood has 50% moisture content. For flat grain boards, the redness value increases statistically with any steaming–drying time, while in quarter pattern boards, this color parameter was not statistically affected (Table 4). Again, this behavior may refer to the changes in the differential redness values (Δa^*), which were positive (above one) for flat pattern boards at all steaming times (Fig. 5(c)). In the quarter pattern boards, the same values were negative, without exceeding 0.5 (Fig. 5(d)).

The color parameter b^* decreased statistically after steaming–drying for both grain patterns in green condition, but for the wood with 50% MC, it was only affected statistically in the flat pattern boards that have been subjected to the steam-drying treatment during 3 and 9 h of steaming and in

A. Berrocal et al.

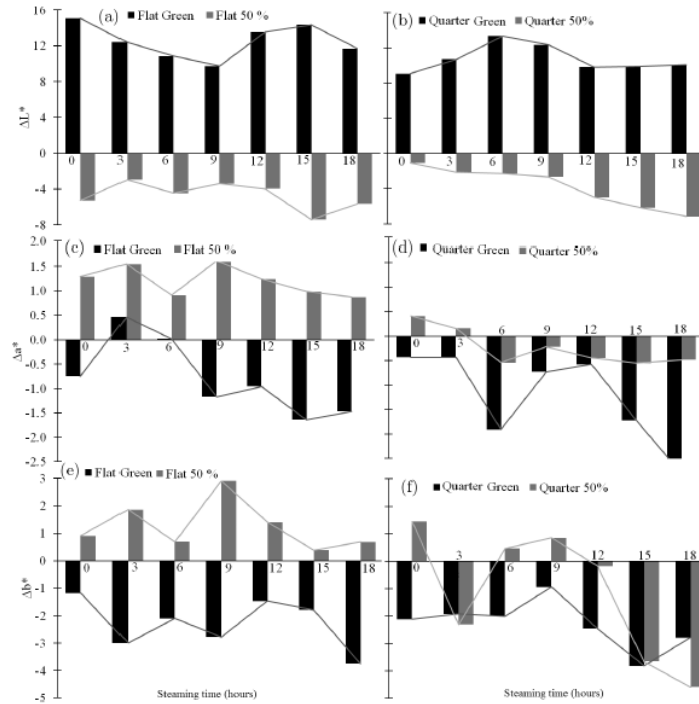

Fig. 5. Color differentials of parameters L^* , a^* and b^* before and after steam-drying *Tectona grandis* flat and quarter pattern boards in two moisture conditions (green and 50% MC).

quarter pattern boards between 15 h and 18 h of steaming (Table 4). The differential change of yellowness (Δb^*) showed that the greatest differentials are observed at 3 and 9 h in flat pattern board, and after 15 h of steaming in quarter pattern boards (Figs. 5(e) and 5(f)).

The behavior of the color parameters is compared to other studies, such as Salas and Moya¹¹ and Basri et al.,³¹ which were conducted under similar moisture or grain pattern conditions. The above mentioned authors found that L^* and b^* diminished statistically when the wood is dried, whereas a^* was statistically unaffected. The results were only congruent for 50% MC wood and not for flat pattern (Table 4) or green-condition wood.

In the evaluation of the surface color change (ΔE^*) after the steam-drying treatment, compared

to the teak from natural forest, a minor change was obtained in the flat grain wood between 3 h and 6 h steaming-drying, for both moisture conditions. Furthermore, color change tends to decrease in quarter pattern boards with increasing steaming-drying time (Fig. 6).

The wood color difference index ΔE^* (Eq. (1)) is expressed as a distance between two points in the color coordinate system, with the quadratic addition of each coordinate difference.²⁰ Cui et al.³² mentioned that the color's change value (ΔE^*) defined the levels at which color differences are perceived. When the values of ΔE^* rise above 10, color change is very appreciable. Consequently, it is preferable to find a steaming condition with the lowest ΔE^* values relative to teak wood from natural forests⁵ in order to

Surface Chemical and Color Characterization of Steam-Dried *Tectona grandis* Wood

Fig. 6. Color change (ΔE^*) of *Tectona grandis* wood surface of flat and quarter pattern boards, in green condition and 50% MC after different steaming-drying times.

achieve the desirable color. According to the ΔE^* values found with the different steaming times and grain patterns (Fig. 6), the lowest color difference between steamed wood and model teak is achieved after 3 h of the steam-drying of the flat pattern boards at 50% moisture content and 6 h of steam-drying of the green condition wood. Meanwhile, for quarter pattern boards, the best condition is 18 h of the steam-drying (Fig. 5).

Color changes relative to changes in the modifications of the chemical composition of the surface of flat pattern boards, coincide with the diminution of the relative intensity between 1596 and 1733 cm^{-1} (Figs. 3(h)–3(l)) and the lowest value of the wood color difference index ΔE^* in this type of grain pattern (Fig. 6). As for the quarter pattern board, with the constant change of the ratio of intensity (ratio I_n/I_{1031}), it also coincides with the decrease of the color change with the steaming time (Fig. 6). This means that color changes of the wood probably occur due to the loss of the C=O group linked to the aromatic skeleton of lignin. Specifically, cross-links have been formed between aromatic units in the lignin. However, hemicellulose degradation may also be occurring. Glucose, for example, showed alteration in the signals at 1318 cm^{-1} (Fig. 3(c)) or xylan, indicated by the alteration in the bands at 1453 cm^{-1} (Fig. 3(d)), which favor dissolution of carbohydrates during steaming,³¹ leaving it more exposed to lignin. As a result, redness (a^*) in the wood tends to be higher in the case of flat green wood after 3 h of

steaming (Fig. 3(c)), and the differences in the values of Δa^* in quarter pattern boards after 18 h of steaming are greater.

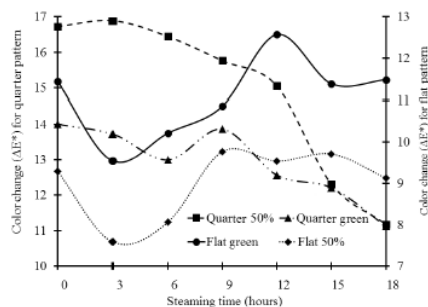
4. Conclusion

The FTIR bands at 1031, 1053, 1108, 1158, 1231, 1318, 1373, 1419, 1453, 1506, 1558, 1595, 1652, 1717 and 1733 cm^{-1} signals in the range studied (800–1800 cm^{-1}) were found to be present in the surfaces of all the different treatments. On the other hand, the chemical components with signals at 1540, 1554, 1575, 1616, 1635, 1675 and 1695 cm^{-1} were evidenced in the FTIR spectra of the quarter pattern samples of wood not subjected to steaming, therefore, were only present in wood before steaming. Regarding the signals at 1158, 1231, 1373 and 1419 cm^{-1} , it was not possible to observe any trend in this intensity; however, bands at 1053, 1108, 1453, 1506, 1536, 1558, 1595, 1652, 1683, 1700 and 1733 cm^{-1} showed a decrease in the vibration ratio with the steaming time. The only signal where this ratio augmented was at 1318 cm^{-1} probably due to the reduction of the cellulose crystallinity by the steaming-drying process, however further research is required to confirm it.

Different steaming-drying times changed the magnitude of the color parameters, L^* in particular, followed by yellowness (b^*) and then by redness (a^*). The evaluation of the color change of the surface due to steaming-drying, with teak wood from natural forests as the model, shows that flat pattern boards present the lowest change between 3 h and 6 h of steaming-drying in the two moisture conditions, while in quarter pattern boards, color change tends to diminish with the increase of the steaming-drying time.

Color changes relative to changes in the modifications of the chemical composition of the surface of flat pattern boards, coincide with the diminution of the relative intensity between 1596 cm^{-1} and 1733 cm^{-1} (Fig. 1) and the lowest value of the wood color difference index ΔE^* in this type of grain pattern (Fig. 5). As for the quarter pattern boards, the constant change of the ratio of intensity (ratio I_n/I_{1031}) also coincides with the decrease of the color change with the steaming time. This means that color changes of the wood probably occur due to the loss of the C=O group linked to the aromatic skeleton of lignin.

A. Berrocal et al.

Acknowledgments

The authors wish to thank the *Vicerrectoría de Investigación y Extensión* at the *Instituto Tecnológico de Costa Rica (ITCR)*, and we thank Life Forestry Costa Rica S.A. for providing a sample of their 11-year-old teak trees from their plantations for the present study.

References

1. FAO, Planted Forests and Trees, Global Planted Forests Thematic Study: Results and analysis, Working Paper No. 38, FAO, Rome (2006).
2. R. Moya, B. Bond and H. Quesada, *Wood Sci. Technol.* **48** (2014) 411.
3. R. Moya and J. Calvo, *Ann. For. Sci.* **69** (2012) 947.
4. P. K. Thulasidas, K. M. Bhat and T. Okuma, *J. Trop. For. Sci.* **18** (2006) 51.
5. R. Moya and B. Marin, *New Forests* **42** (2011) 3296.
6. K. M. Bhat, *Wood News* **9** (1999) 48.
7. R. Moya and A. Berrocal, *Ann. For. Sci.* **67** (2010) 107.
8. S. Fehér, S. Komán, Z. Börcsök and R. Taschner, *BioResources* **9** (2014) 3456.
9. Y. Cao, J. Jiang, J. Lu, R. Huang, J. Jiang and Y. Wu, *BioResources* **7** (2012) 2809.
10. A. Berrocal and P. Agüero, *Kuri Rev. For.* **7** (2006) 1.
11. C. Salas and R. Moya, *Drying Technol.* **32** (2014) 301.
12. J. Guo, K. Song, L. Salmén, Y. Yin, *Carbohydrate Polym.* **115** (2015) 207.
13. X. N. Huang, D. Kocaefe, Y. Kocaefe, Y. Boluk and C. Krause, *Appl. Surf. Sci.* **264** (2013) 117.
14. F. Lionetto, R. Sole, D. Camoletta, G. Vasapollo and A. Maffezzoli, *Materials* **5** (2012) 1910.
15. J. S. Stevanic and L. Salmén, *Holzforschung* **63** (2009) 497.
16. D. Varga and M. E. Van der Zee, *Holz Roh. Werk.* **66** (2008) 11.
17. L. Calienno, C. Pelosi, R. Picchio, G. Agresti, U. Santamaria, F. Balletti and A. L. Monaco, *Stud. in Conserv.* **60** (2015) 131.
18. M. Y. Li, S. C. Cheng, D. Li, S. N. Wang, A. M. Huang and S. Q. Sun, *Chin. Chem. Lett.* **26** (2015) 221.
19. R. S. Hunter and R. W. Harold, *HunterLab: The Measurement of Appearance* (John Wiley and Sons, New York, 1996).
20. American Society for Testing and Materials (ASTM), ASTM D2244-11: Standard Practice for calculation of Color Tolerances and Color differences from instrumentally measured color coordinates, ASTM, West Conshohocken, PA (2014).
21. A. K. Moore and N. L. Owen, *Appl. Spectrosc. Rev.* **36** (2001) 65.
22. N. H. Okoye, A. N. Eboatu, J. S. Fabiyi, P. I. Udeozo, R. U. Arinzea and S. C. Odinma, *Am.-Eurasian J. Sci. Res.* **9** (2014) 45.
23. G. Bonifazi, L. Calienno, G. Capobianco, A. Lo Monaco, C. Pelosi, R. Picchio and S. Serranti, *Polym. Degrad. Stab.* **113** (2015) 10.
24. M. Åkerholm and L. Salmén, *Polymer* **42** (2001) 963.
25. L. P. Ramos, *Quím Nova* **26** (2003) 863.
26. G. Garrote, H. Domínguez and J. C. Parajó, *Holz Roh. Werk.* **59** (2001) 53.
27. B. Dos Santos, V. Sâmia, G. I. Bolzon and J. L. Monteiro de Matos, *Cerne* **20** (2014) 337.
28. M. Nakamura, Y. Miyake and T. Nakano, *J. Wood Sci.* **58** (2012) 505.
29. N. Gierlinger, D. Jacques, M. Grabner, R. Wimmer, M. Schwanninger, P. Rozenberg and L. E. Pâques, *Trees* **18** (2004) 102.
30. J. C. Valverde and R. Moya, *Color Res. Appl.* **39** (2014) 519.
31. E. Basri, D. Rohadi, T. Priadi and I. Wahyudi, *J. Ilmu Tek. Kayu Tropis* **2** (2004) 57.
32. W. Cui, P. Kamdem and T. Rypstra, *Wood Fiber Sci.* **36** (2004) 291.

4. Artículo 4. Efecto de tratamientos de secado-vaporizado sobre el contenido de humedad, tasa de secado, color y defectos de secado en madera juvenil de *Tectona grandis* proveniente de plantaciones de rápido crecimiento.

**EFFECTO DE TRATAMIENTOS DE SECADO-VAPORIZADO SOBRE EL
CONTENIDO DE HUMEDAD, TASA DE SECADO, COLOR Y DEFECTOS DE
SECADO EN MADERA JUVENIL DE *Tectona grandis* PROVENIENTE DE
PLANTACIONES DE RÁPIDO CRECIMIENTO**

Alexander Berrocal, Roger Moya, María Rodríguez y Freddy Muñoz

RESUMEN

Tectona grandis es la segunda especie más importante de reforestación en Costa Rica, por lo que cualquier mejora en su proceso de industrialización es relevante, específicamente en el proceso de secado. Las tablas a ser muestreadas, obtenidas a partir de una plantación de *Tectona grandis* de 12 años, fueron utilizadas para evaluar tres programas de secado, integrados con un proceso de vaporizado, con el fin de determinar el efecto combinado del sistema de secado-vaporizado en la calidad de la madera sometida a este proceso. La variación del contenido de humedad, en relación al tiempo de secado antes y después del período de vaporizado en madera tangencial y radial, fue modelado matemáticamente. Como resultado, en ambos tipos de madera, se observan dos líneas de tendencia en la disminución del contenido de humedad (CH%) con el tiempo de secado. La tasa de secado, para la madera con de corte tangencial y radial, no fue afectado por el proceso de vaporizado y un punto de inflexión fue observado a las 30 horas (40% CH de la madera) el cual permaneció constante, hasta el final del tratamiento. Cambios moderados en los parámetros del color, expresados en termino de los componentes del sistema CIELab, fueron observados. La etapa de vaporizado, integrada al programa de secado, tanto en madera de corte tangencial, como en madera de corte radial, mejoró la incidencia o magnitud de los defectos de secado, dependiendo del tipo de madera y del programa de secado empleado.

Palabras clave: Tasa de secado, programas de secado, vaporizado de la madera, madera juvenil, *Tectona grandis*.

INTRODUCCIÓN

Tectona grandis L. f. es la especie más utilizada, en climas tropicales, para la reforestación comercial (Moya *et al.*, 2014). El área sembrada, estimada para esta especie, es de 4,35 millones de hectáreas en 52 países diferentes (Kollert y Cherubini 2012). Gracias a sus propiedades físicas, mecánicas y estéticas, la madera de esta especie tropical, se ha convertido en una de los más importantes en los mercados internacionales (Moya *et al.*,

2014). La Teca, junto con la caoba (*Swietenia* sp) y el cedro rojo (*Cedrela odorata*), son las maderas duras tropicales con mayor demanda en el mercado de maderas finas (Keogh 2009).

Sin embargo, para estas especies, el prolongado proceso de secado, junto con el alto porcentaje de madera juvenil (Moya *et al.*, 2014, Berrocal *et al.*, 2016b), la aparición de defectos de secado (Salas & Moya, 2014) y la imposibilidad en la consecución de un color uniforme en la madera seca, son algunos de los inconvenientes encontrados cuando se compete con otras maderas tropicales (Valverde & Moya, 2014; Berrocal *et al.*, 2016a).

En relación con el secado de madera de plantación de *T. grandis*, investigaciones anteriores se han centrado en la aplicación de secado a alta temperatura y la calidad de secado. Hsueh y Jing-Sheng (1997) estudiaron 3 diferentes métodos de secado y encontraron los tiempos de secado más rápidos con alta temperatura. Basri y Wahyudi (2013) compararon la calidad de la madera de los árboles jóvenes de *T. grandis* (menos de 10 años de edad) con la madera de árboles de más de 45 años de edad y encontraron una menor calidad de la madera seca de los árboles jóvenes. Pleschberger *et al.* (2013) estudiaron, de nuevo, el efecto del uso de altas temperaturas y humedad de equilibrio (CHE) en diferentes programas de secado, pero los resultados se focalizaron en las propiedades mecánicas de la madera. Si bien, estas investigaciones se han concentrado en mejorar el tiempo de secado, olvidaron mencionar el cambio de color de la madera.

Dos programas de secado fueron modificados al incrementar la temperatura (5°C) y disminuir el contenido de humedad de equilibrio, más la adición de tres nuevas etapas en los tiempos de secado, recomendados para la madera de teca. El tiempo de secado se redujo de 140 a 105 horas con un bajo consumo de energía, aproximadamente se redujo en un 25%, sin embargo hay una ligera disminución en la calidad de la madera seca. Además se encontró que los parámetros de color madera se vieron afectados por la aplicación de programas de secado con alta temperatura, dando un tono más rojizo (a *) y amarillo (b *) en la madera (Berrocal *et al.*, 2016c). Por lo tanto se recomiendan el programa de secado detallado en la Tabla 1, para la madera de árboles de teca de plantaciones de rápido crecimiento.

Recientemente, Salas y Moya (2014) encontraron que la luminosidad disminuyó mientras el enrojecimiento y amarilleo aumentaron después del proceso de secado de la madera con tres métodos diferentes (aire, horno y secado solar), lo que resulta en la madera más oscura. Berrocal *et al.* (2016a) estudiaron el efecto de tres programas de secado diferentes para reducir el tiempo de secado. En este estudio se modificaron los tiempos de secado del programa recomendado (Anexo H) por Sidney *et al.* (1988) para madera de *T. grandis* de bosque natural a madera de plantación. Dos programas de secado fueron modificados por medio del incremento de la temperatura (5 °C) y la disminución del contenido de humedad de equilibrio, más la adición de tres nuevas etapas en los tiempos de secado recomendados para la madera de teca. Como resultado se redujo el tiempo de secado de 140 a 105 horas con un disminución en el consumo de energía, aproximadamente el 25% en la reducción, pero hay una ligera disminución en la calidad de la madera seca. Además se encontró que los parámetros de color madera se vieron afectados por la aplicación de programas de secado a mayor temperatura, dando un tono más rojizo (a *) y amarillo (b *) en la madera (Berrocal *et al.*, 2016c). Posteriormente se recomiendan los programas de secado que se detallan en la Tabla 1, para la madera de árboles de plantaciones de rápido crecimiento.

Por otro lado, existen varias técnicas para homogeneizar el color de la madera, o para tratar de lograr colores oscuros más uniformes (Fehér *et al.*, 2014). El tratamiento vapor-secado ha sido conocido, durante mucho

tiempo, como uno de los métodos más eficaces para mejorar la estabilidad dimensional, incrementar la resistencia a la degradación y la durabilidad de la madera; así como también simultáneamente lograr un oscurecimiento del color de la madera (Cao *et al.*, 2012). En términos del mecanismo para el desarrollo del color oscuro, las propiedades y las cantidades de los principales compuestos químicos y la composición de los extractivos en la madera, se modifican durante el tratamiento con vapor de calor (Cao *et al.*, 2012).

En madera juvenil de teca, Berrocal *et al.* (2016a) encontraron que diferentes tiempos de secado-vaporizado cambian la magnitud de los parámetros de color, L^* , en particular, seguido de la amarillez (b^*) y luego por enrojecimiento (a^*) y los cambios de color de la madera probablemente ocurren debido a la pérdida del grupo $C = O$ que está unido al esqueleto aromático de la lignina. Sin embargo, este estudio fue llevado a cabo en una cámara de vapor piloto y una estufa para muestras pequeñas.

Aunque se han llevado a cabo esfuerzos para estandarizar el color de la madera de teca de los árboles de plantación, relativamente pocas investigaciones se han llevado a cabo para estudiar los cambios producidos por un proceso de vaporizado en combinación con el secado al horno con madera procedente de plantaciones de árboles de rápido crecimiento. Por lo tanto el objetivo de este estudio fue evaluar el efecto de los tratamientos de vapor-secado en el color de madera juvenil de *Tectona grandis* proveniente de plantaciones de rápido crecimiento. Por otra parte, fueron evaluados el contenido humedad final, los defectos de secado (alabeo, encorvadura, arquedaura, acanaladura, grietas y rajaduras), la tensión y la tasa de secado.

MATERIALES Y MÉTODOS

Características de la plantación y patrón de corte: las muestras (tablas) fueron obtenidas a partir de trozas provenientes de un segundo raleo de 12 años de edad, de una plantación de *Tectona grandis* situada en la región de la Península de Osa de Costa Rica, con un espaciamiento de 3 x 3 m (1100 árboles ha⁻¹). La densidad del rodal fue de 475 árboles ha⁻¹ en el momento del muestreo, con un diámetro medio a la altura del pecho (DAP) de 24,5 cm y una altura total de 15,6 metros. Un total de 30 árboles fueron muestreados y cortados y seccionados a una longitud 1,25 m, de tal forma que unas 250 trozas fueron obtenidas, aproximadamente. Para este experimento, 125 trozas fueron aserradas de tal forma que se obtuvieran tablas de corte tangencial y otras 125 trozas para obtener tablas de corte radial.

Programas de secado: Los programas de secado ensayados se obtuvieron a partir de dos estudios previos (Berrocal *et al.*, 2016a y Berrocal *et al.*, 2016b.). En el primer estudio, Berrocal *et al.* (2016a) evaluaron el proceso de secado-vaporizado con diferentes tiempos de vaporizado (0, 3, 6, 9, 12, 15 y 18 horas) en la madera juvenil de *T. grandis* para tablas de corte tangencial y tablas de corte radial y dos contenidos de humedad (verde y 50 %); mediante la variación del color de la madera. A partir de este estudio se encontró que el color de la superficie de la madera es más oscuro cuando las tablas están sometidas al vapor durante 15 horas a 50% de CH. En el segundo estudio, Berrocal *et al.* (2016b) probaron tres tiempos de secado diferentes derivados del programa "H" (Tabla 1) de Sydney *et al.* (1988) para madera de *T. grandis*. A partir de este estudio, se determinó que la madera de árboles de teca de plantaciones de rápido crecimiento, se puede secar con 3 pasos adicionales al programa "H" (Sydney *et al.*, 1988) y se aumentó en 5 °C la temperatura de bulbo seco en el secado final, generando el llamado "programa para madera juvenil". Esta programación se detalla en la Tabla 1. Finalmente, el último tratamiento corresponde al

período vaporizado aplicado en el "programa para madera juvenil". El vaporizado, se aplicó cuando el contenido de humedad alcanza el 50% de CH durante 15 horas (Tabla 1).

Tabla 1. Programa de secado recomendado por Sydney *et al.*, (1988) y programa de secado utilizado para madera juvenil de *Tectona grandis* proveniente de plantaciones de rápido crecimiento.

Etapa	Programa "H" ¹			Programa para madera juvenil			Programa para madera juvenil con vaporizado		
	BS °C	CHE %	CH %	BS °C	CHE %	CH %	BS °C	CHE %	CH %
Calentamiento	55	-	60	55	-	-	55	-	-
	58	14	60	-	-	-	58	14	-
Secado	60	13.8	30	58	14.0	60	58	14.0	60
	60	10.0	25	60	12.5	50	60	12.5	50
							15 horas de vaporizado		
	70	7.7	20	60	10.0	40	60	10.0	40
	70	6.4	20	65	8.5	35	65	8.5	35
	75	3.7	10	70	7.7	30	70	7.7	30
				75	6.4	25	75	6.4	25
				80	5.0	20	80	5.0	20
			80	3.7	12	80	3.7	12	
Equilibrio	75	11.0	-	80	11.0	12	80	11.0	12
Acondicionamiento	75	11.5	-	80	11.5	-	80	11.5	-
Enfriamiento	35	11.5	-	35	-	-	35	-	-

Leyenda: BS: Temperatura de bulbo seco (°C) / CHE: Contenido de humedad en equilibrio (%) / CH: Contenido de humedad (%). ¹De acuerdo con Sydney *et al.* (1988)

Secado de la madera y vaporizado: El ensayo de secado de madera se realizó en un horno convencional con una capacidad de 2 m³ de capacidad (cámara piloto NARDI®, Italia) el cual cuenta con una fuente de energía eléctrica para calentar la resistencia dentro de la cámara. La madera verde se apila en paquetes de 10 tablas de ancho y 30 piezas de altura, para un total de 300 piezas por carga de secado. Reglas de madera de 2.5x2.5 cm de sección transversal fueron utilizados como separadores entre las tablas. La madera fue apilada en el piso de la secadora, posteriormente se formó una caja totalmente cerrada con la ayuda de paredes 3 cm de espesor, de doble foro e internamente relleno de fibra de vidrio como aislante (Figura 1), para formar una caja de vaporizado. Para poder generar el vapor durante el secado, fue utilizado un tanque de almacenamiento de agua sellado herméticamente (Figura 1). El agua que estaba dentro del tanque fue calentado por medio de un calentador de gas licuado de propano (LPG), lo cual generó vapor a una temperatura de 115 °C y a una presión de 478 Pa, este vapor es llevado por medio de una manguera a la pequeña cámara construida para almacenar la madera. El proceso de vaporizado fue mantenido por 15 horas. El programa para madera juvenil fue aplicado una vez para madera radial y una vez para madera tangencial. Por su parte, el programa que incluía el vaporizado fue aplicado dos veces, por cada patrón de corte, de tal forma que se trabajó por duplicado.



Figura 1. Cámara para el proceso de vaporizado, fabricada dentro del horno con el sistema de producción de vapor por medio de calentamiento de agua con gas licuado de petróleo.

Control del contenido de humedad: Para el control CH (%), seis muestras se obtuvieron de la parte central de seis tablas representativas de la carga de madera, apiladas para cada lote de secado. Estas muestras se colocaron a diferentes alturas en cada lado de la pila. Dos muestras se encontraban a 25 cm del suelo, otras dos muestras se encuentra a 25 cm de la parte superior y las dos muestras restantes se encuentra a 50 cm de las otras muestras. El CH fijado para el final del secado fue del 12%. Además del CH% de las muestras testigo, se midió el de cada una de las tablas antes y después del secado. El CH (%) antes del secado, fue llamado "CH inicial" (CH_i), para su determinación una sección transversal de 2,5 cm de espesor se extrajo de cada tabla. El CH_i se determinó en esta pequeña muestra de acuerdo con la norma ASTM D4442-07 (ASTM 2012). El CH final (CH_f) fue determinado por medio de una sección transversal de 2,5 cm de espesor que se extrajo de cada tabla después del secado y CH (%) se midió de nuevo utilizando la norma ASTM D 4442-07 (ASTM 2012).

Evaluación de los defectos de secado: Los defectos de las tablas evaluadas se midieron antes y después del secado y los parámetros analizados fueron alabeo, encorvadura, arquedaura, acanaladura, grietas y rajaduras. La metodología que se detalla en Salas y Moya (2014) y Tenorio *et al.* (2012) se utilizó para evaluar todos los defectos de secado. La norma oficial Nch993EO72 chilena se utilizó para determinar el Índice de Calidad (IQ), que se calcula para los seis defectos y se divide de acuerdo con la ecuación 1 (Pérez *et al.*, 2007). Sus valores y las medias se detallan en Salas y Moya (2014) y Tenorio *et al.* (2012).

$$I = \frac{(Na*0)+(Nb*0,5)+(Nc*2)+(Nd*2,5)}{M} \quad (1)$$

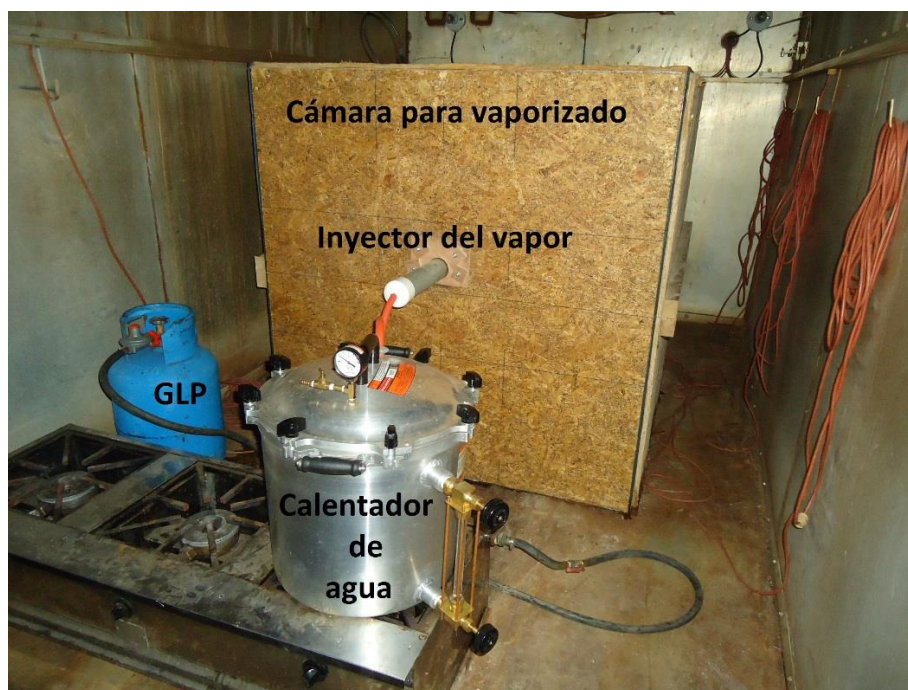
Donde:

I: Índice de calidad

Na: Número de piezas sin ningún tipo de defecto (torceduras, grietas y rajaduras).

Nb: Número de piezas con presencia leve de torceduras, grietas y rajaduras.

Nc: Número de piezas con presencia moderada de torceduras, grietas y rajaduras.

Nd: Número de piezas con presencia severa de torceduras, grietas y rajaduras.

M= Número de piezas totales.

Evaluación del color: El color fue determinado para 42 piezas seleccionadas al azar antes del secado para cada uno de los tratamientos, para el ámbito de la medición se seleccionó solamente el duramen. Después del secado, el color se midió de nuevo en la misma zona seleccionada. Para obtener los valores para el sistema cromatológico estandarizado CIEL*a*b, se empleó un espectrofotómetro modelo MiniScan XE Plus. La información detallada de las condiciones de medición del color se describe en detalle Berrocal *et al.* (2016a). El cambio de color (ΔE^*) se determinó por medio de los valores L^* , a^* y b^* medidos antes y después del secado, calculado de acuerdo con la fórmula establecida en la norma ASTM D 2244 (ASTM, 2014).

Regarding quality evaluation, each defect was analysed based on its percentage of incidence and the magnitude of severity before and after drying.

Análisis estadístico: El coeficiente de variación y los valores medios de MCI y MCF para cada tipo de secado fueron determinados; lo mismo que la distribución de frecuencia de los datos, que se representan gráficamente para mostrar la variación de los dos parámetros de CH (%) para cada secado. Un ANDEVA de una vía fue aplicado para las variables MCI y MCF, así como para los parámetros de color de madera (L^* , a^* b^*) medidos en los diferentes programas de secado, para determinar si había diferencias significativas para cada parámetro. La prueba de Tukey se utilizó para probar la diferencia media con un nivel de significancia de $p < 0,01$. El programa estadístico SAS 8.1 para Windows (SAS Institute Inc., Cary, Carolina del Norte) fue utilizado para llevar a cabo el análisis. En cuanto a la evaluación de la calidad, se analizó cada defecto en función de su porcentaje de incidencia y la magnitud de la gravedad, antes y después del secado.

RESULTADOS

Contenido de humedad y tiempo de secado.

El CH_i de la madera, utilizada para los diferentes tratamientos de vaporizado fue superior al 100%, para el caso de las muestras testigo, el tratamiento de madera radial con vapor, fue el que presentó el valor de CH_i estadísticamente mayor. Sin embargo, a la hora de considerar todas las tablas de la carga, no se presentaron diferencias estadísticas en el CH_i , entre patrones de corte o entre tratamientos de vaporizado (Tabla 1).

Tabla 1. Contenido de humedad inicial y final, así como tiempo de secado para madera de *Tectona grandis* de corte radial y corte tangencial con y sin tratamiento de vaporizado.

Patrón de corte	Datos para muestras testigo			Datos para todas las tablas	
	CH_i (%)	CH_f (%)	Tiempo de secado (h)	CH_i (%)	CH_f (%)
Tangencial sin vaporizado	115 ^A (2.56)	13.17 ^A (2.18)	80.5	107.84 ^A (10.32)	12.83 ^A (7.47)
Tangencial con vaporizado	105 ^A	12.55 ^A	85.0	104.25 ^A	12.64 ^A

	(7.26)	(5.67)		(11.43)	(8.42)
	132 ^B	12.97 ^A	132.0	106.67 ^A	12.26 ^A
Radial sin vaporizado	(17.07)	(5.55)		(12.35)	(11.65)
	100 ^A	12.63 ^A	100.0	102.67 ^A	11.86 ^A
Radial con vaporizado	(18.51)	(4.30)		(13.24)	(10.40)

Nota: Letras para el mismo contenido de humedad, indican significancia estadística al 99%. Los valores entre paréntesis representan el coeficiente de variación.

Para el *CHF* no se encontró diferencia estadística entre los lotes de secado tanto en las muestras testigo como en todas las tablas de los diferentes lotes. En todos los casos el valor fue próximo a 12% que fue el CH (%) de referencia fijado en los programas de secado (Tabla 1). Semejanza en los valores de *CHi* y *CHF* entre las mediciones de las muestras testigo y las mediciones de todas las tablas, fue observada. En relación al tiempo de secado fue observado que los tiempos en la madera con patrón de corte tangencial, presentaron tiempo de secado mayor que la madera con patrón radial (Tabla 1). La madera de corte radial vaporizado solamente aumentó 5 horas en relación al tiempo de secado de la madera sin vaporizado, en tanto que en la madera de corte radial, el aumento en tiempo fue de 32 horas en la madera seca con vaporizado con respecto al tratamiento sin vaporizado.

Contenido de humedad en relación con el tiempo de secado

La variación del contenido de humedad, en relación al tiempo de secado antes y después del período de vaporizado en madera tangencial y radial, puede ser modelado matemáticamente y en ambos tipos de madera se observa dos líneas en la disminución del CH con respecto al tiempo de secado (Figura 2). El punto de inflexión ocurrió al inicio de la etapa de vaporizado. En tablas de corte tangencial, se presenta la misma tendencia en la madera vaporizada y en la madera sin vaporizar; desde el inicio del secado hasta las 30 horas el CH (%) de la madera disminuye, desde su condición verde hasta 40 % (Figura 2a). Después del vaporizado la variación del contenido de humedad, con respecto al tiempo, tiene una disminución hasta alcanzar el 12% de *MC* en los dos secado. La disminución en la madera, a la que no se le aplicó el vaporizado, fue mas lento (aprox. 0.35%/hour); en relación a la madera que fue sometida a una etapa de vaporizado (aprox. 0.83%/hours), sin embargo alcanzó en menor tiempo el 12% CH.



Figura 2. Variación del contenido de humedad en relación con el tiempo de secado para madera de *Tectona grandis* de corte tangencial y radial, con y sin el tratamiento de vaporizado.

En las tablas de corte radial, también se presenta una inflexión cuando el CH (%) es aproximadamente 40% o en las 30 horas de secado (Figura 2b). También se observa una leve diferencia en la tendencia, tanto antes como después del vaporizado (Figura 2b). Antes del punto de inflexión, la madera con vaporizado presenta una disminución en el CH (%) en relación a la madera que no fue vaporizada (1,67 y 1,88 % hora⁻¹, respectivamente). Posterior a la inflexión (40% CH o 30 horas), la madera que no ha sido vaporizada disminuyó más lentamente (aprox. 0,33% hora⁻¹), mientras que la madera que ha tenido una etapa de vaporizado, alcanzó una tasa de disminución de 0,46% hora⁻¹ hasta lograr el 12% de CH (Figura 2b).

Tasa de secado en relación con el tiempo de secado

La tasa de secado para la madera de corte tangencial y radial, no fue afectado por el proceso de vaporizado y nuevamente se observa una inflexión a las 30 horas o 40% de CH de la madera (Figura 3).

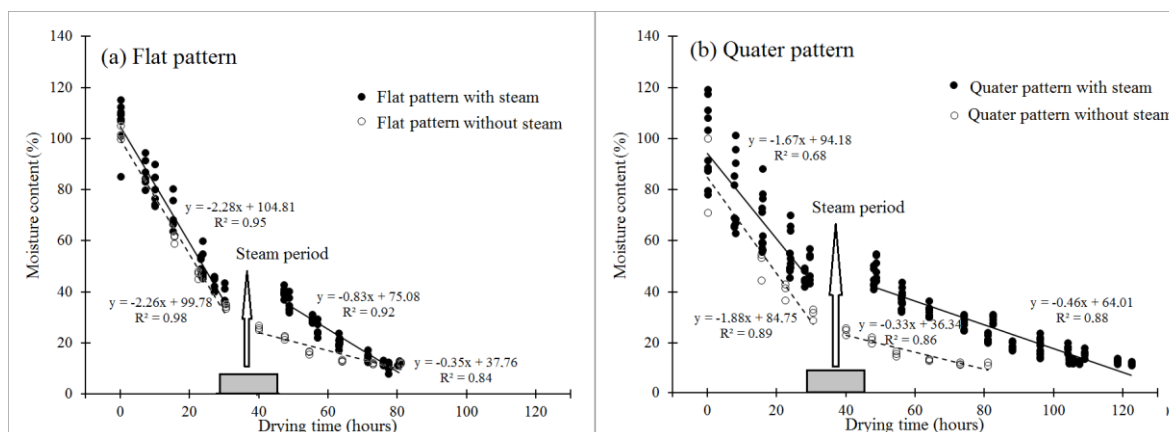

Figura 3. Variación de la tasa de secado (% hora⁻¹) en relación con el tiempo de secado para madera de *Tectona grandis* de corte radial y tangencial con y sin tratamiento de vaporizado.

Sin embargo se observa un cambio en el comportamiento en ese punto de inflexión. Antes de este punto, se muestra una tendencia de disminución de la tasa de secado con respecto al tiempo para los dos tipos de madera y los dos tratamientos (vaporizada y no vaporizada); sin embargo luego de la inflexión, la tendencia de tasa de secado es constante hasta el final del secado, en las diferentes condiciones de madera estudiada (Figura 3).

Cambio de color de la madera

En la Tabla 2 se reportan los valores promedio de los parámetros del color del sistema CIELab antes y después del secado en la madera con y sin tratamiento de vaporizado. Para el parámetro L* (luminosidad) en las tablas de corte tangencial, antes del secado, con y sin tratamiento de vaporizado, no hay diferencia en el color; sin embargo luego del secado, las tablas que fueron vaporizadas presentan menor valor en el parámetro L* en comparación con la madera sin vaporizado. A su vez, en las tablas que fueron vaporizadas no se vio afectado estadísticamente el parámetro L* antes y después del secado. Sin embargo, en las tablas que no recibieron el tratamiento de vaporizado, ocurrió un aumento significativo del parámetro L* luego del secado. Las tablas de corte radial, antes

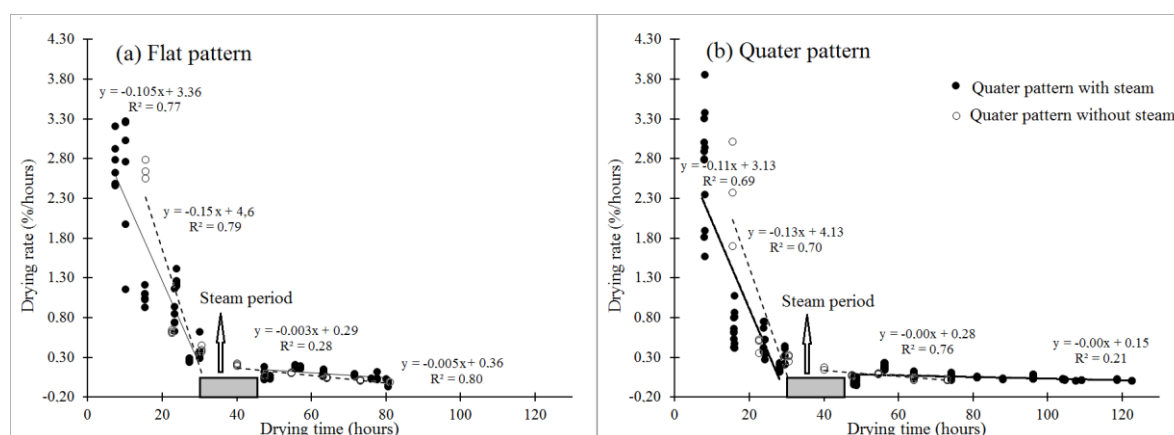
del secado y vaporizadas presentan un valor estadísticamente mayor que las tablas sin tratamiento de vaporizado; sin embargo luego del secado la tablas que fueron vaporizadas presentan un valor estadísticamente menor de L^* en comparación con la madera sin vaporizado. Así mismo, en las tablas vaporizadas disminuyó estadísticamente el parámetro L^* luego del secado; mientras que en las tablas sin vaporizar ocurrió un aumento de L^* (Tabla 2).

Tabla 2. Parámetros del sistema de color $L^*a^*b^*$ de madera de *Tectona grandis* de corte tangencial y radial, antes y después del secado, con y sin tratamiento de vaporizado.

Patrón de corte	Tratamiento de Vaporizado	Parámetro L^*		Parámetro a^*		Parámetro b^*	
		Antes	Después	Antes	Después	Antes	Después
Tangencial	Con	48.6 ^A (20.3)	53.5 ^A (11.7)	10.6 ^A (21.4)	8.9 ^B (16.5)	25.9 ^A (14.2)	21.9 ^B (14.5)
	Sin	50.4 ^A (6.3)	61.0 ^B (16.1)	10.0 ^A (17.9)	8.5 ^B (14.9)	24.4 ^A (13.3)	26.3 ^A (19.6)
Radial	Con	51.7 ^A (17.6)	37.4 ^B (14.3)	9.5 ^A (23.7)	5.0 ^B (12.0)	27.3 ^A (13.2)	13.4 ^B (21.3)
	Sin	47.5 ^C (18.5)	53.4 ^A (13.7)	9.8 ^A (21.0)	9.9 ^A (21.1)	26.7 ^A (14.1)	23.4 ^C (10.3)

Nota: Las letras indican significancia estadística al 99% entre los parámetros del color antes y después del secado, así como también con y sin tratamiento de vaporizado. Los valores entre paréntesis representan el coeficiente de variación.

Para el parámetro a^* (enrojecimiento) no se presenta diferencia significativa entre las tablas vaporizadas y sin vaporizar, antes del secado tanto en las tablas de corte tangencial, como en la de corte radial. Luego del secado, hay una disminución significativa en las tablas de corte tangencial vaporizadas y sin vaporizar; sin embargo en la tablas de corte radial solamente disminuyó el parámetro a^* luego del secado en las tablas vaporizadas, además se observa una disminución significativa en la madera vaporizada en comparación con la madera sin vaporizar (Tabla 2).

Para el parámetro b^* (amarillez), nuevamente no se presentan diferencias estadísticas entre las tablas vaporizadas y sin vaporizar antes del secado en la madera de corte radial y tangencial. Posterior al secado, se presenta una disminución significativa de este parámetro en las tablas que han sido vaporizadas, para los dos tipos de patrón de corte. En tanto que en las tablas sin vaporizar, solamente ocurrió un aumento significativo de b^* luego del secado en las tablas de corte tangencial; sin embargo para las tablas de corte radial, hubo una disminución significativa al comparar antes y después del secado (Tabla 2).

Al evaluar el cambio de color (ΔE^*) la madera vaporizada de corte tangencial, presenta un valor ΔE^* menor que la madera sin vaporizar (Figura 4a); pero en la madera de corte radial, las tablas vaporizadas presentan mayor valor que las tablas sin vaporizar (Figura 4b). En relación con el cambio del parámetro L^* (ΔL^*), en las tablas de corte tangencial, ocurrió en menor magnitud en las tablas con vaporizado (Figura 4a) y nuevamente como ocurrió en el ΔE^* , en las tablas de corte radial, el mayor cambio se dio en las tablas con vaporizado (Figura 4b). Para los cambios de los parámetros a^* y b^* (Δa^* y Δb^* , respectivamente) luego del secado, los mayores valores se presentan en las tablas con tratamiento de vaporizado en la madera de corte tangencial radial (Figura 4).



Figura 4. Cambio de color ΔE^* , cambio de luminosidad (ΔL^*), enrojecimiento (Δa^*) y amarillez (Δb^*) en madera de corte radial y tangencial de *T. grandis* secada con y sin vaporizado.

Defectos de secado

En la evaluación de la incidencia de los defectos de secado (Figura 5), antes del secado las tablas de corte tangencial (Figura 5a) presentaron poca o nula incidencia de alabeo, acanaladura, grietas and rajaduras tanto en la madera vaporizado como en la madera sin vaporizar y por lo tanto la magnitud de estos defectos es próximo a 0 mm (Figura 6a). En tanto que después del secado la incidencia de alabeo, encorvadura y acanaladura aumentó en la tablas con y sin vaporizar, siendo la acanaladura la de mayor aumento (Figura 5a). En el caso de la madera con vaporizado, la incidencia de acanaladura y alabeo fue menor en relación con la madera sin vaporizar, pero la incidencia de los defectos de grietas y rajaduras fue mayor en la madera vaporizada, sin embargo la magnitud fue igual que la madera vaporizada (Figura 6a). Los defectos de arqueadura y encorvadura están presentes en la madera antes del secado en la tablas de corte tangencial, vaporizadas y sin vaporizar (Figura 5a). Luego del secado, la incidencia de arqueadura disminuye en forma similar en las tablas vaporizadas y sin vaporizar (Figura 5a), pero con la ventaja de que en las tablas vaporizadas disminuye la magnitud (Figura 6a). En tanto que para encorvadura, en las tablas vaporizadas, aumenta la incidencia (Figura 5a) y la magnitud (Figura 6a).

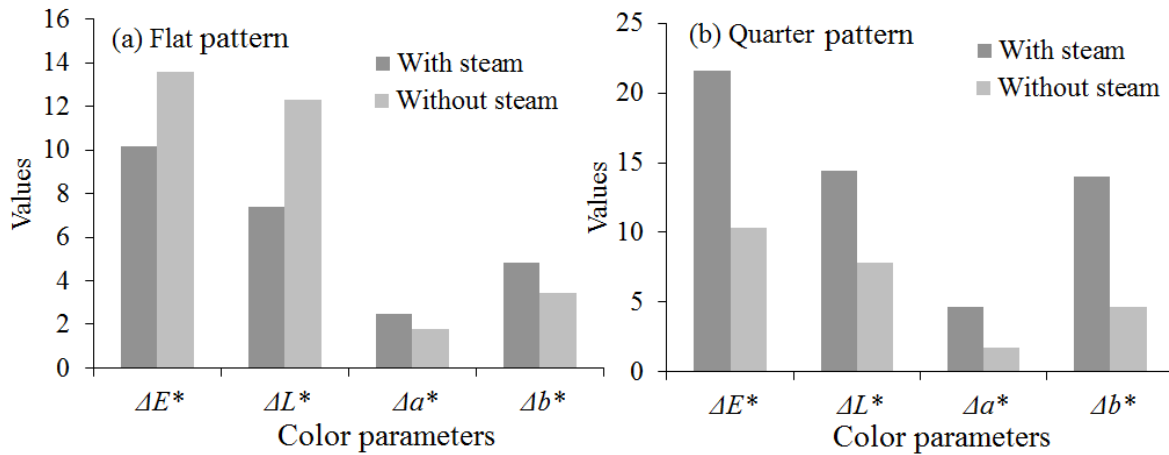

Figura 5. Porcentaje de incidencia de los defectos: alabeo, arqueadura, encorvadura, acanaladura, grietas y rajaduras, en madera de *T. grandis* de corte radial y tangencial antes y después de los tratamiento de secado y secado-vaporizado.

En las tablas de corte radial, la incidencia de alabeo, acanaladura, grietas and rajaduras fue menor al 10% en la madera vaporizada y sin vaporizar antes del secado (Figura 5b), además aquellas tablas con estos defectos presentaban magnitudes sobre 1 mm (Figura 6b). Luego del secado, la incidencia de estos 4 defectos aumentó, no obstante el secado junto con el vaporizado produjo una menor incidencia y magnitud de estos defectos en comparación con sólo el secado, en especial la incidencia de acanaladura y grietas (Figura 5b y 6b). Los defectos arqueadura y encorvadura están presentes en un porcentaje 10-20 y 30%, respectivamente antes del secado, en las tablas con y sin vaporizado. Las magnitudes de estos defectos, en la madera vaporizada y sin vaporizar, son sobre 2 mm (Figura 6b). Luego del secado, la incidencia de estos dos defectos aumentan en la misma proporción en las tablas vaporizadas y sin vaporizar (Figura 5b), sin embargo la magnitud es ligeramente menor en la tablas que han sido vaporizadas (Figura 6b).

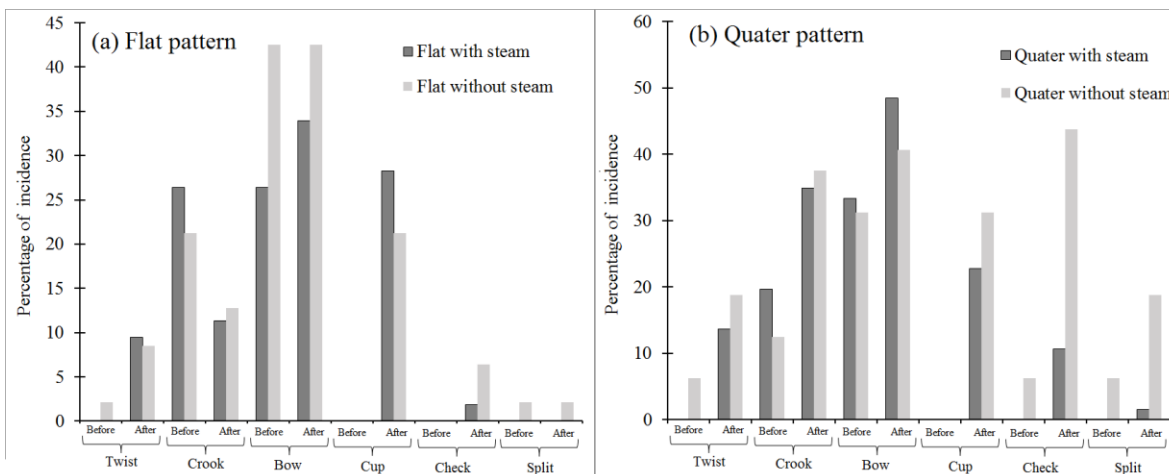

Figura 6. Magnitud de los defectos alabeo, arqueadura, encorvadura, acanaladura, grietas y rajaduras, en madera de *T. grandis* de corte radial y tangencial antes y después de los tratamiento de secado y secado-vaporizado.

Finalmente en la evaluación de la contracción de la madera se encontró que la tablas que fueron vaporizadas y las que no se les aplicó esta tratamiento no presentaban diferencia estadísticas en los valores de contracción en el ancho de la tabla (Tabla 3).

Tabla 3. Porcentaje de contracción de las tablas de madera juvenil de *T. grandis*, de corte radial y tangencial, con y sin vaporizado.

Corte tangencial		Corte radial	
Con vaporizado	Sin vaporizado	Con vaporizado	Sin vaporizado
3.29 (28)A	3.25 (36)A	1.90 (68)A	1.87 (59)A

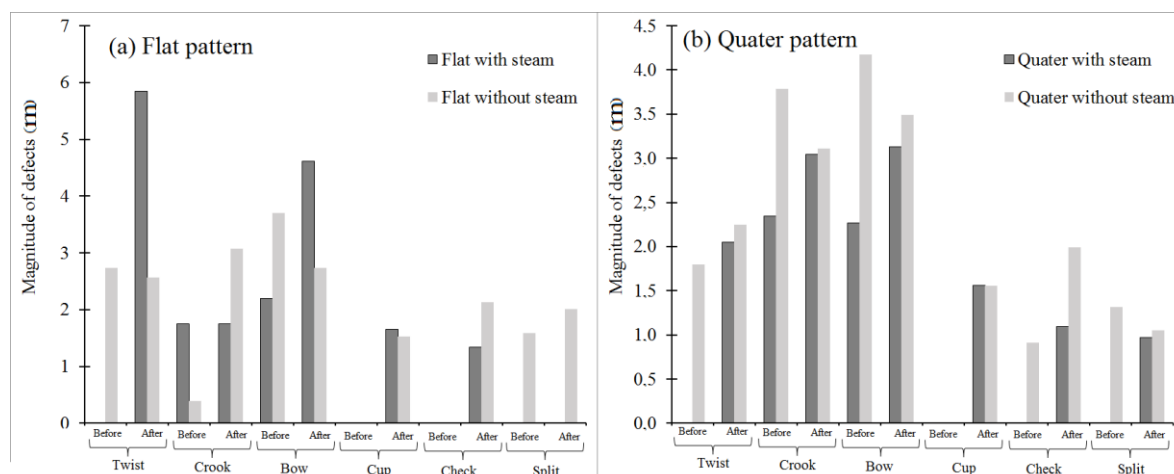
DISCUSIÓN

Los valores de *CHi* en la madera de teca antes del secado (sobre el 100%) son congruentes con otros estudios realizados en madera juvenil de esta especie (Berrocal *et al.*, 2016, Salas y Moya, 2014). Por ejemplo Berrocal *et al.* (2016) encontró valores entre 86% a 115%, rango que contiene los valores de humedad del presente estudio. En tanto que Salas y Moya (2014), indican un rango entre 57% y 109%, y nuevamente este rango es congruente con los valores de *CH* (%) encontrados en este estudio. Otro aspecto importante a destacar es que no se presentan amplias diferencias en el *CHi* de la madera de los diferentes patrones de corte, esto lo que permite es que en un eventual secado que combine tablas con diferentes patrones de corte, todas las tablas presentarán un *CHi* más uniforme entre ellas, y se evita la variabilidad en la pérdida de humedad en las etapas iniciales de secado (Tenorio *et al.*, 2011).

En relación al *CHf*, es importante señalar que tanto la madera que fue vaporizada como la que no fue vaporizada tendieron a alcanzar el *CH* de referencia-12% (Tabla 3). Esta condición es una ventaja cuando se vaporiza la madera, dado que no se está viendo afectado el *CHf* de la madera, por lo que es posible la elaboración de productos de buena calidad ya que los lotes de madera seca tenderán a presentar las mismas condiciones de *CHf* (Berrocal *et al.*, 2016, Gu *et al.*, 2004).

Un aspecto importante a destacar, es que a la hora de comparar los valores de *MCi* y *MCf* presentados en las muestras testigos y en la totalidad de las tablas, hubo poca variación, a excepción de la muestras testigo en el secado de tablas de corte radial a las que no se les aplicó el vaporizado, por lo que el muestreo realizado cumplió con lo establecido, es decir que debe corresponder a la representatividad total del lote de madera (Simpson, 1999)

El tiempo de secado está ampliamente relacionado con el rango de secado (Tenorio *et al.*, 2016), y esto se vio reflejado en el presente estudio, ya que cuando se utilizan programas de secado con altos rangos de secado, se logra obtener menor tiempo de secado, como el caso de los tratamientos DS-2 y DS-3 (Tabla 3).

El tiempo total de secado encontrado en la madera de diferentes patrones de corte, con y sin tratamiento de vaporizado, es muy inferior a los determinados por Salas y Moya (2014), los cuales reportan de 216-264 horas. Así mismo, se logra mantener un tiempo similar al encontrado por Berrocal *et al.* (2016a), que reportó de 105-142 horas y que recomendó estos programas para el secado de la madera de plantación de teca. Igualmente, aunque se aplique una etapa de vaporizado, se logró secar la madera de *T. grandis* entre 100 y 140 horas; siendo ligeramente superior al tiempo utilizado para secar *Pinus radiata* (Ananias *et al.*, 2012), que es una de las especies de más rápido secado artificial en horno.

La etapa de vaporizado, aplicada durante en el secado, no presentó efectos en el *MCf* de la madera (Tabla 3). No obstante el tiempo de secado aumentó en un 15% (Tabla 3). A pesar de que múltiples estudios han mostrado que el tiempo de secado se ve favorecido por la vaporización (Alexiou *et al.*, 1990, Harris *et al.*, 1989, Rezende *et al.*, 2015, Severo *et al.*, 2013), no fue posible observar este comportamiento en la madera de *T. grandis*. Dicho comportamiento puede ser explicado por un tiempo de vaporizado alto (18 horas) en relación al tiempo total de secado y por otro lado a una alta tasa de secado (que reduce el tiempo de secado). Por ejemplo en estudios realizados en especies tropicales como eucalipto (Alexiou *et al.*, 1990, Rezende *et al.*, 2015, Severo *et al.*,

2013) se reportan tiempos de secado de 450-500 horas y una tasa de secado de 0.007065 %/hora en madera con proceso de vaporizado, en tanto que el la madera de teca en el presente estudio presenta tiempo de secado de 82-110 horas, tiempo de secado menor a los mencionado para eucalipto y rangos de secado sobre 0.3 %/hora, muy superior al reportado por la especie anterior.

El efecto del vaporizado en el cambio del color del duramen de la madera de *T. grandis* está asociado a cambios químicos (Berrocal *et al.*, 2016a). Durante el periodo de vaporizado los compuestos polifenólicos del duramen de *Juglans* sp., que le confieren el color oscuro, pueden migrar a la albura y la oscurecen durante el proceso de vaporizado (Sandoval-Torres *et al.*, 2010).

Con respecto al efecto del vaporizado en el color de la madera de *T. grandis*, los resultados obtenidos son contrastantes con lo reportado por la literatura. Tolvaj *et al.* (2010) indicaron que para *Robinia pseudoacacia* el parámetro L* disminuye y los parámetros a* y b* aumentan con la temperatura y tiempo de vaporizado. Para el caso de coníferas (*Pinus sylvestris* y *Picea abies*) el efecto es similar, dado que el tiempo y la temperatura de vaporizado son los parámetros que tienen mayor efecto en el cambio de color. Una disminución en la luminosidad y un incremento en el parámetro a* son observados, sin embargo con respecto al parámetro b* la tendencia varía dependiendo de la temperatura (con 80 °C o menos aumenta el parámetro b* y con una temperatura mayor el parámetro b* disminuye). A mayor tiempo de vaporizado, el cambio en el color quedó mayormente definido (Tolvaj *et al.*, 2012).

Straže *et al.* (2008) determinaron, para *Prunus avium*, en un ensayo de secado-vaporizado, que el efecto del tratamiento con vapor mostró un comportamiento diverso en los parámetros del color de la madera (siendo afectado por la temperatura de vaporizado); comprobando el hecho de que el tiempo de vaporizado es un parámetro esencial para el cambio en los parámetros del color de la madera.

Además del tiempo la temperatura, en el proceso de vaporizado, es otro parámetro relevante y dependiente de la especie; por ello Tolvaj y Molnár (2006) determinaron que para *Robinia pseudoacacia*, en un rango de temperatura de 80 a 130 °C, el cambio de color es más rápido y requiere menos tiempo, en comparación con rangos menores. Para *Quercus cerris*, el tiempo óptimo de homogenización del color de la madera fue de 12 horas a una temperatura de 80-95°C y de 6 horas a una temperatura de 110 °C. Para *Fagus silvatica* el tiempo adecuado fue de 18 horas, no importa la temperatura de vaporizado en un rango de temperatura de 80-95 °C.

Por su parte, Varga y van der Zee (2008) encontraron que los resultados del vaporizado dependen altamente de la especie de madera tratada. Para *R. pseudoacacia* el vaporizado es un método adecuado para la homogenización del color de la madera, especialmente a alta temperatura de vaporizado. Así mismo, la alteración del tono para *Q. robur* e *Hymenolobium petraeum* fue indetectable para la mayoría de parámetros, del color y solamente se observó un decrecimiento moderado de L* a altas temperaturas. Por otra parte, el color de *Intsia bijuga* cambió ligeramente durante el tratamiento. A pesar de que el tiempo de vaporizado es más importante que la temperatura, en lo referente al cambio de color, tanto el tiempo como la temperatura son factores significativos para explicar el cambio de color.

De acuerdo con Durgante-Severo *et al.*(2013) al integrar un tratamiento de vaporizado, previo a un programa de secado, se logró una significativa reducción del contenido de humedad inicial, un incremento en la

tasa de secado y un decrecimiento en el gradiente de humedad dentro de las tablas sometidas a secado. Demostrando que el vaporizado previo al secado puede ser adecuado para reducir los tiempos de secado de *Eucalyptus dunnii*.

Teniendo en consideración lo anteriormente indicado, futuros estudios deben incluir la posibilidad de evaluar un sistema de vaporizado a más alta temperatura (superior a 110 °C) y un mayor tiempo de vaporizado (superior a 24 horas), considerando que ambos factores han sido reportados como esenciales para lograr una modificación significativa del color del duramen de la madera.

CONCLUSIONES

1. La variación del contenido de humedad, en relación al tiempo de secado antes y después del período de vaporizado en madera de corte tangencial y radial, puede ser modelado matemáticamente y en ambos tipos de madera se observa dos líneas en la disminución del contenido de humedad (CH%) con el tiempo de secado. Así mismo con respecto a la tasa de secado, en relación con el tiempo de secado, se obtuvo que la tasa de secado para la madera de corte radial y tangencial no fue afectada por el proceso de vaporizado y se observa una inflexión a las 30 horas o 40% de contenido de humedad de la madera.
2. En relación al cambio de color, se determinó que éste se ve influenciado por el tratamiento de vaporizado y el patrón de corte de la madera. En el parámetro L* (luminosidad) la madera vaporizada presenta un menor valor, con respecto al parámetro a* (enrojecimiento). Para el caso del parámetro b*(amarillez) el comportamiento es similar y tanto el tipo de corte como el tratamiento, tienen un efecto significativo en la reducción de este parámetro después de secado. Al evaluar el cambio de color (ΔE^*), la madera vaporizada y de corte tangencial, presenta un valor ΔE^* menor que la madera sin vaporizar, pero en la madera de corte radial las tablas vaporizadas presentan mayor valor que las tablas sin vaporizar.
3. Con respecto a los defectos de secado, en la madera la incidencia de alabeo, encorvadura y acanaladura aumentó en las tablas con y sin vaporizar, siendo la acanaladura el de mayor aumento. En el caso de la madera con vaporizado, la incidencia de acanaladura y alabeo fue menor en relación con la madera sin vaporizar, pero la incidencia de los defectos de grietas y rajaduras fue mayor en la madera vaporizada, sin embargo la magnitud fue igual que la madera vaporizada, además la madera vaporizada presenta una menor magnitud en estos defectos. Por su parte en la madera de corte radial, la incidencia de alabeo, acanaladura, grietas y rajaduras fue menor al 10% en la madera antes del secado. Luego del secado, la incidencia de estos 4 defectos aumentó, no obstante el secado junto con el vaporizado produjo una menor incidencia y magnitud de estos defectos, en especial la incidencia de acanaladura y grietas.

AGRADECIMIENTOS

Los autores desean agradecer a la Vicerrectoría de Investigación y Extensión del Instituto Tecnológico de Costa Rica (ITCR) por el apoyo financiero para la realización del presente estudio.

REFERENCIAS

- Ananías, R. A., Ulloa, J., Elustondo D. M., Salinas C., Rebolledo, P. & Fuentes C. (2012). Energy consumption in industrial drying of radiata pine. *Drying Technology*. 30(7): 774-779.
- ASTM (American Society for Testing and Materials). (2012). Standard Test Methods for Direct Moisture Content Measurement of Wood and Wood-Base Materials. American Society for Testing and Materials. D-4442-07 International, West Conshohocken, PA.
- ASTM (American Society for Testing and Materials). (2014). *Standard practice for calculation of color tolerances and color differences from instrumentally measured color coordinates*. D-2244-11kSTM International, West Conshohocken, PA.
- Alexiou, P. N., Wilkins, A. P. & Hartley, J. (1990). Effect of pre-steaming on drying rate, wood anatomy and shrinkage of regrowth *Eucalyptus pilularis* Sm. *Wood Science and Technology*. 24(1): 103-110.
- Basri, E. & Wahyudi, I. (2013). Wood Basic Properties of Jati Plus Perhutani from different ages and their relationships to drying properties and qualities. *Journal Penelitian Hasil Hutan* 31(2): 93-102
- Berrocal, A., Moya, R., Rodríguez-Solís, M., Starbird R. & Muñoz, F. (2016a). Surface chemical and colour characterization of juvenile *Tectona grandis* wood subjected to steam-drying treatments: effect of grain pattern and moisture content. *Surface Review and Letters* 23(1): 1-14. DOI: 10.1142/S0218625X15500912.
- Berrocal, A., Moya, R., Bond, B., Rodríguez-Solís, M. & Muñoz, F. (2016b). Decrease in kiln drying time of juvenile *Tectona grandis* L. wood using drying rate. *Wood Fiber and Science* (submitted).
- Berrocal, A., Moya, R., Rodríguez-Solís, M., Muñoz, F. & Pérez, D. (2016c). Drying of plantation-grown *Tectona grandis* wood with daily-controlled drying rate schedules: Effects on final moisture content, drying time, wood color and drying defects. *Journal of Tropical Forest Science* (submitted).
- Cao, Y., Jiang, J., Lu, J., Huang, R., Jiang, J. & Wu, Y. (2012). Color change of Chinese fir through steam-heat treatment. *Color of steam-treated wood*. *BioResources* 7(3): 2809-2819.
- Durgante-Severo, E. T., Tomaselli, I. & Willians-Calonego, F. (2013). Effect of steam thermal treatment on the drying process of *Eucalyptus dunnii* variables. *Cerne, Lavras*. 19(4): 637-645.
- Fehér, S., Komán, S., Börcsök, Z., & Taschner, R. (2014). Modification of hardwood veneers by heat treatment for enhanced colors. *BioResources*. 9(2), 3456-3465.
- Gu, H., Young, T. M., Moschler, W. W., Bond, B. H. (2004). Potential sources of variation that influence the final moisture content of kiln- dried hardwood lumber. *Forest Products Journal*. 54(11): 65-70.
- Harris, R. A., Schroeder, J. G., & Addis, S. C. (1989). Steaming of red oak prior to kiln-drying: Effects on moisture movement. *Forest Products Journal*. 39(11/12):70-72.
- Hsueh, A. & Jing-Sheng, N. (1997). Study on the kiln drying of teak, India-charcoal trema, Formosan alder and schefflera tree 3-cm thick lumber. *Bulletin National Pingtung Polytechnic Institute*. 6(1): 41-48.
- Keogh, R. (2009). The future of teak and the high-grade tropical hardwood sector: Planted forests and trees working paper FP/44E. Available at <http://www.fao.org/forestry/site/10368/en/>
- Kollert, W. & Cherubini, L. (2012) Teak resources and market assessment 2010. FAO Planted Forests and Trees Working Paper FP/47/E, Rome. Available at <http://www.fao.org/forestry/plantedforests/67508@170537/en/>

- Moya, R., Bond, B. & Quesada-Pineda, H. (2014) A review of heartwood properties of *Tectona grandis* trees from fast-growth plantations. *Wood Science and Technology* 48(2): 411-433.
- Pérez, P., Ananías, R. A. & Hernandez, G. (2007). Estudio experimental del secado de renovales de canelo *Drimys winteri*. *Maderas Ciencia y Tecnología*. 9: 59–70.
- Pleschberger, H., Hansman, C., Müller, U. & Teischinger, A. (2013). Fracture energy approach for the identification of changes in the wood caused by the drying processes. *Wood Science and Technology*. 47: 1323-1334.
- Rezende, R. N., Lima, J. T., Paula, L. E. D. R. & Silva, J. R. M. D. (2015). Effect of the steaming on the drying of *Eucalyptus grandis* boards. *Cerne*. 21(1): 37-43.
- Severo, E. T. D., Tomaselli, I., Calonego, F. W., Ferreira, A. L. & Mendes, L. M. (2013). Effect of steam thermal treatment on the drying process of k variables. *Cerne*. 19(4): 637-645.
- Salas, C. & Moya, R. 2014. Kiln-, solar-, and air-drying behavior of lumber of *Tectona grandis* and *Gmelina arborea* from fast-grown plantations: moisture content, wood color, and drying defects. *Drying Technology: An International Journal*. 32(3): 301-310.
- Sandoval-Torres, S., Jomaa, W., Marc, F. & Puiggali, J. R. (2010). Causes of color changes in wood during drying. *Forestry Studies in China*. 12(4):167-175
- Simpson, W. (1999). Drying and control of moisture content and dimensional changes. In *Wood Handbook- Wood as an Engineering Material*; Gen. Tech. Reo. FPL-GTR-113, Madison, WI: U.S. Department of Agriculture, Forest Service, Forest Products Laboratory, 463.
- Straže, A. & Gorišek, Ž. (2008). Research on colour variation of steamed cherrywood *Prunus avium* L. *Wood Research*. 53 (2):77-90.
- Sydney, R., Charles, J., Kozlik, P., Bois, J. & Wengert, E. (1988). Dry kiln schedules for commercial woods: Temperate and tropical. US Forest Service Forest Products Laboratory: Madison, WI 158. *General Technical Report FPL-GTR-57*.
- Tenorio, C. & Moya, R. (2011). Kiln drying of *Acacia mangium* Willd wood: Considerations of moisture content before and after drying and presence of wet pockets. *Drying Technology*. 29(15):1845-1854.
- Tenorio, C., Moya, R. & Quesada-Pineda, H. (2012). Kiln drying of *Acacia mangium* wood: Colour, shrinkage, warp, split and check in lumber before and after drying. *Journal of Tropical Forest Science*. 24 (1):125-139.
- Tenorio, C., Salas, C. & Moya, R. (2015). Kiln drying behavior utilizing drying rate of lumber from six fast-growth plantation species in Costa Rica. *Drying Technology*. 34(4):443-453.
- Tolvaj, L. & Molnár S. (2006). Colour homogenization of hardwood species by steaming. *Acta Silvatica & Lignaria. Hungara*. 2:105-112.
- Tolvaj, L., Hungary, S., Molnár, S., Németh, R. & Varga, D. (2010). Color modification of black locust depending on the steaming parameters. *Wood Research*. 55(2):81-88
- Tolvaj, L., Papp, G., Varga, D. & Lang, E. (2012). Effect of the steaming on the colour change of softwoods. *Bioresources*. 7(3):2799-2808.

- Valverde, J. C. & Moya, R. (2014). Correlation and modeling between color variation and quality of the surface between accelerated and natural tropical weathering in *Acacia mangium*, *Cedrela odorata* and *Tectona grandis* wood with two coating. *Color Research and Application* 39(5) 519-529.
- Varga, D. & van der Zee, M. E. (2008). Influence of steaming on selected wood properties of four hardwood species. *Holz Roh Werkst.* 66:11-18