

CONSTANCIA DE DEFENSA PÚBLICA DE PROYECTO DE GRADUACIÓN

Proyecto de Graduación defendido públicamente ante el Tribunal Evaluador, integrado por los profesores Ing. Gustavo Rojas Moya, Ing. Adrián Chaverri Coto, Ing. Giannina Ortiz Quesada, Ing. Ángel Navarro Mora, como requisito parcial para optar por el grado de Licenciatura en Ingeniería en Construcción, del Instituto Tecnológico de Costa Rica.

GUSTAVO
ADOLFO
ROJAS MOYA
(FIRMA)

Firmado digitalmente
por GUSTAVO
ADOLFO ROJAS
MOYA (FIRMA)
Fecha: 2021.12.06
10:47:40 -06'00'

Ing. Gustavo Rojas Moya.
Director

ADRIAN
CHAVERRI
COTO
(FIRMA)

Firmado
digitalmente por
ADRIAN CHAVERRI
COTO (FIRMA)
Fecha: 2021.12.06
15:17:09 -06'00'

Ing. Adrián Chaverri Coto.
Profesor Guía

GIANNINA
ORTIZ
QUESADA
(FIRMA)

Firmado digitalmente
por GIANNINA ORTIZ
QUESADA (FIRMA)
Fecha: 2021.12.03
08:16:36 -06'00'

Ing. Giannina Ortiz Quesada.
Profesora Lectora

ANGEL HUMBERTO
NAVARRO MORA
(FIRMA)

Firmado digitalmente
por ANGEL HUMBERTO
NAVARRO MORA (FIRMA)
Fecha: 2021.12.06
09:39:56 -06'00'

Ing. Ángel Navarro Mora.
Profesor Observador

Cartago, 24 de noviembre del 2021.

CARTA DE REVISIÓN DE ESTILO

INSTITUTO TECNOLÓGICO DE COSTA RICA

ESCUELA DE INGENIERÍA EN CONSTRUCCIÓN

Estimados señores:

Por este medio yo, Raquel Hernández Castro, incorporada al Colegio de Licenciados y Profesores en Letras, Filosofía, Ciencias y Artes, Costa Rica, con el número de código **030130**, portadora de la cédula de identidad **110260883**, hago constar que revisé y corroboré la incorporación de los cambios al Proyecto final de graduación: **Estudio de capacidad de carga viva del puente sobre el río Sucio, ubicado en la Ruta 32**. Para optar por el grado de Licenciatura en Ingeniería en Construcción que pertenece al estudiante, Joseph Rodríguez Cambronero, cédula: **1-16380668**. Se le ha realizado al documento las correcciones respecto a la acentuación, ortografía, puntuación, concordancia gramatical, coherencia y cohesión en la estructura de los párrafos y otros aspectos morfosintácticos y relativos a los vicios de dicción.

En espera de que la revisión cumpla con los requerimientos del Instituto Tecnológico de Costa Rica se suscribe atentamente,

A handwritten signature in black ink, appearing to be 'Raquel Hernández', is written over a solid horizontal line.

Licda. Raquel Hernández.

Código No.030130

**Estudio de capacidad de carga
viva del puente sobre el río
Sucio, ubicado en la ruta 32**

Abstract

This document is a study of the bridge over the Sucio River on National Route 32 that connects San José with the country's Caribbean, which is one of the most important routes in the country. The structural analysis was carried out by creating a 3D model in order to evaluate the live load capacity of the bridge. A prestressed concrete bridge with a continuous box-type super structure was created, with a substructure and reinforced concrete foundations. Axial, bending and shear tests were performed according to the AASHTO LRFD (2020) standard to establish the current limitations of the structure. Where it was found that the controlled transit of a live load of 150 tons through the bridge at 10 km / h of the special loads for the Modernization project of the Ventanas Garita hydroelectric plant of the Instituto Costarricense de Electricidad is safe.

Keywords: Structural Analysis, Bridge, Visual Evaluation

Resumen

Este documento es un estudio del puente sobre el río Sucio en la ruta nacional 32 que comunica San José con el Caribe del país, la cual es una de las rutas más importantes del país. El análisis estructural se realizó mediante la creación de un modelo 3D con el fin de evaluar la capacidad de carga viva del puente. Se recreó un puente de concreto preesforzado de super estructura continua tipo cajón, con subestructura y fundaciones de concreto reforzado. Se realizaron pruebas axiales, de flexión y cortante según la normativa AASHTO LRFD (2020) para establecer las limitaciones actuales de la estructura. En donde se encontró que es seguro el tránsito controlado de una carga viva de 150 toneladas por el puente a 10 km/h de las cargas especiales, para el proyecto de Modernización de la planta hidroeléctrica Ventanas Garita del Instituto Costarricense de Electricidad.

Palabras clave: Análisis estructural, Puentes, Evaluación Visual

Estudio de capacidad de carga viva del puente sobre el río Sucio, ubicado en la ruta 32

JOSEPH RODRIGUEZ CAMBRONERO

Proyecto final de graduación para optar por el grado de
Licenciatura en Ingeniería en Construcción

Diciembre 2021

INSTITUTO TECNOLOGICO DE COSTA RICA
ESCUELA DE INGENIERIA EN CONSTRUCCIÓN

Contenido

Prefacio	1
Resumen Ejecutivo	2
Introducción	4
Marco Teórico	6
Metodología	14
Resultados	27
Análisis de Resultados	37
Conclusiones	40
Recomendaciones	41
Referencias	43
Apéndices	45
Anexos	58

Prefacio

El puente sobre el río Sucio en la ruta 32 es una de las estructuras más importantes de la ruta, la cual es a su vez una de las vías más importantes del país, este puente fue construido hace casi 35 años, durante los cuales como en la mayoría de puentes del país el mantenimiento ha sido mínimo o con reparaciones deficientes y contraproducentes para la propia estructura como las sobrecapas asfálticas.

Este puente es parte del plan logístico para el transporte de equipos de generación eléctrica los cuales pueden ingresar al país por medio de los puertos del caribe y pacífico, ya que esos equipos en general poseen pesos mayores a los normales que transitan por las vías y generan esfuerzos mayores los cuales pueden dañar o incluso colapsar puentes en malas condiciones problema que ha ocurrido anteriormente en otros países.

El ICE tiene en cuenta que es posible arriesgar esta u otras estructuras nacionales y afectar su propia logística, por lo tanto, realiza un esfuerzo por mantener un monitoreo de las rutas que podrían estar dentro de los planes logísticos de compra y transporte de equipos.

Es por ello que se realizan revisiones estructurales que permiten generar un criterio de seguridad sobre el estado y capacidad de estas estructuras. Con el fin de mantener los planes actualizados para la organización correcta de estos proyectos que tienen un alto precio.

Es por ello que el estudio del puente sobre la ruta 32 pretende establecer la capacidad de carga viva máxima a la cual se puede someter el puente sin generar daños que inhabilite la ruta.

Agradecimientos

Agradezco a Dios por ser la guía y la fuerza para seguir el camino. A mis padres quienes con su arduo trabajo siempre me apoyaron; y confiaron en mis sueños. Al ICE por la oportunidad de generar este proyecto. Y agradezco a todos los profesores que durante años aportaron a la creación de mi perfil personal y profesional, en especial al Ing. Adrián Chaverri quien con su guía y compromiso fue fundamental en este proceso.

Resumen Ejecutivo

El Instituto Costarricense de Electricidad realiza actualizaciones de los equipos de generación eléctrica, con el fin de mantener su alta productividad, es así como actualmente se encuentra en la actualización de los equipos de la represa hidroeléctrica Ventanas Garita.

Para este tipo de actualizaciones se realizan monitoreos de las potenciales rutas de transporte de equipos con el fin de mantener actualizados los esquemas logísticos. Uno de los elementos críticos de este monitoreo es la verificación de los puentes en estas rutas, pues es probable que sean expuestos a cargas superiores a las presupuestadas en los diseños iniciales.

En este documento se realizó el estudio del puente sobre el río Sucio en la ruta 32 la cual conecta la zona caribe con la ciudad capital. El mismo fue analizado de forma exhaustiva en el 2007 por parte del estudio conjunto JICA-MOPT, en este se encontraron deformaciones anormales generadas por errores tanto en el diseño como en su fase constructiva pero sin impacto importante en la clasificación de diseño, por lo que se reiteró que se diseñó previendo cargas HS20-44+25%, el puente fue revisado en el 2015 por el programa eBridge de CIVCO en donde se constató que el mismo mantuvo su condición en un rango satisfactorio, sin un deterioro importante. Aun y cuando es conocido que en el país no se cuenta con un correcto mantenimiento de los puentes y vías en general.

El objetivo de este proyecto fue analizar el puente y determinar la carga viva de tránsito segura a utilizar en este puente sin comprometerlo estructuralmente, utilizando la máxima carga que puede acarrear el ICE con sus equipos actuales.

Por lo tanto, se recomienda establecer comprobaciones visuales del estado del puente

con el fin de establecer el estado en los momentos de uso y posibles limitaciones.

También se realizó un modelo estructural en 3D, mediante el programa especializado de la firma Computers and Structures Inc CSIBridge versión 21, con los planos existentes se realizó un modelo similar a la estructura real con las láminas estructurales que aún mantiene el MOPT siendo una de las limitaciones más importantes, El modelo consta de una superestructura de concreto preesforzado de tipo viga cajón continua, una inclinación en su eje longitudinal de 3.3%, y la subestructura y fundaciones de concreto reforzado, con el cual se obtuvo el modelo que se presenta a continuación:



Figura 1: Puente 3D. Fuente: Elaboración Propia

Con el modelo anterior se obtuvieron resultados de los esfuerzos de axiales, flexión y cortantes en la estructura, además de las deflexiones generadas por el propio peso como por la carga de paso.

Los resultados anteriores permitieron comprobar la premisa de JICA; gran parte de las deflexiones anormales en el puente son producto de un mal diseño inicial y otra parte es consecuencia de problemas constructivos, a los cuales sumadas las cargas se generan deflexiones superiores a las recomendadas por AASHTO pero en un evento aislado no comprometen la estructura.

También se realizaron estudios de flexión y cortante los cuales se vieron limitados por problemas relacionados con las reproducciones de los planos, donde algunas de las láminas ya no

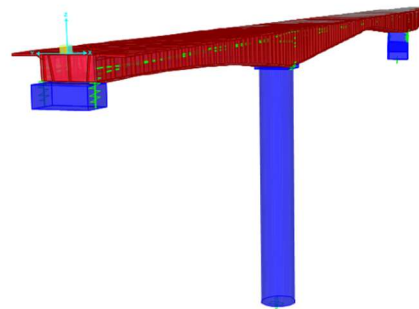
están disponibles, y en otras faltan muchos detalles.

Ante lo cual se determinó seguir comprobaciones muy conservadoras con los mínimos establecidos para el diseño AASHTO LRFD.

En relación con lo mencionado anteriormente se revisó cada una de las partes de la estructura, se determinó que el puente posee una capacidad suficiente para soportar las cargas previstas por el ICE en condiciones controladas.

Cabe mencionar que no se realizaron estudios de torción ya que el puente tendría el paso cerrado para que la carga sea transportada por el centro del mismo, los esfuerzos torsores serían muy bajos, sin ser necesaria la revisión.

Tampoco se realizaron comprobaciones sísmicas por solicitud del ICE y la baja probabilidad de que se dé un evento importante en menos de 10 minutos, en los que será utilizada la estructura.

Finalmente se definió que la carga de 150ton a una velocidad máxima de 10km/h es una carga segura para ser transportada por el puente sin poner en peligro de falla estructural o por servicio de la estructura.

Introducción

En Costa Rica según datos de CIVCO (2019) únicamente el 3% de los puentes se encuentran en una condición satisfactoria y casi 37% en condiciones deficientes, lo cual presenta un escenario complejo para algunas logísticas especiales de transporte.

Las verificaciones visuales y estructurales de los puentes permiten establecer la condición y limitaciones de un puente ante diversos esfuerzos. Para realizar esas verificaciones en Costa Rica existen metodologías de evaluación visuales de puentes como la establecida por el Manual de Inspección Visual de puentes del MOPT y las metodologías planteadas por los programas eBridge y PITRA, también se utiliza la normativa internacional proporcionada mayoritariamente por AASHTO (Manual Bridge Evaluation, LRFD bridge design specifications) y el FHWA (bridge Inspector Reference Manual, Regarding and Coding Guide for the Structure Inventory and Appraisal of the Nation), que se utilizan para el diseño, establecer la seguridad de uso de un puente o la necesidad de intervenciones.

Ya sea por un diseño inicial o el mantenimiento deficiente a través de los años, se generan diversos factores que afectan el puente y provocan que no sea apto para el tránsito de algunas cargas, como las necesarias en los proyectos hidroeléctricos del ICE, es por ello que para el ICE, es necesario monitorear los puentes los cuales podrían afectar la logística de los proyectos e incidir incluso en la elección final de los equipos a instalar en un proyecto hidroeléctrico.

Manterola (2016) menciona que la misión para el diseño de los puentes recae en evitar los grandes esfuerzos y deformaciones a los cuales se exponen este tipo de estructuras.

Es por ello que en este documento se presentan las inspecciones visuales y estructurales realizadas al puente sobre el río Sucio en la Ruta 32 con el fin de evitar sobreesfuerzos en este.

El puente sobre el río Sucio fue construido en 1987, anteriormente ha sido objeto de dos estudios los cuales evidenciaron que el puente poseía deflexiones anormales debido a un mal diseño y errores en la fase constructiva, pero con un mantenimiento satisfactorio a través del tiempo.

Este puente consta de una superestructura continua tipo viga cajón preesforzada la cual descansa sobre pilas de concreto reforzado y un apoyo directo sobre la superficie por medio de un contrapeso. A la estructura además de las ya mencionadas pruebas visuales se le realizaron pruebas para conocer la capacidad ante esfuerzos de flexión y cortantes sin presencia de sismo, pues el puente ha sido catalogado de bajo riesgo ante esta amenaza.

Para el estudio se enfrentaron limitaciones principalmente referentes a los planos, esto producto de que no hay registro de los planos originales de 1984, sino que existen solo algunas láminas reproducidas 20 años después. Lo que obligó a evaluar el puente de forma conservadora con base en los mínimos de diseño para asegurar la seguridad del puente.

Objetivo General

Evaluar la capacidad de carga viva a la cual puede ser expuesto el puente sobre el río Sucio en la ruta 32, mediante la elaboración de un modelo del puente el cual permita la aplicación de la metodología AASHTO de evaluación teórica, con el fin de establecer un peso máximo de los equipos electromecánicos requeridos para transportar los equipos para la modernización de la planta Ventanas Garita.

Objetivos Específicos:

Realizar el estudio bibliográfico para seleccionar los conceptos y requerimientos que permitan seleccionar una metodología de evaluación teórica de puentes la cual se adapte mejor al estudio.

Elaboración de un modelo estructural de los diferentes elementos que componen el puente e intervienen en la capacidad de soportante del mismo.

Realizar el análisis del modelo para así aplicar la metodología de evaluación de puentes y determinar la capacidad de carga y deformaciones del puente.

Marco Teórico

Los puentes son estructuras particulares prueba de esto es que son excluidos del Código Sísmico de Costa Rica, y es que en general para su diseño e inspección se utilizan organismos internacionales como entes de referencia, por lo tanto, a continuación, se presenta un resumen de conceptos importantes.

Puentes

El Manual For Bridge Evaluation “MBE” de AASHTO (2018) define un puente como una estructura que se construye sobre una depresión, obstrucción o río con el fin de permitir el tránsito o transporte de cargas por medio de una calzada o vía férrea mediante una estructura de al menos 7m de longitud, en Costa Rica existen al menos 1670 puentes solo en las rutas nacionales según datos de CIVCO (2019).

Según el Manual de Inspección de Puentes del MOPT (2007) los puentes se dividen en accesorios, superestructura, subestructura y accesos de aproximación, los cuales se amplían a continuación:

Accesorios

Son elementos que no poseen una función estructural, pero son necesarios para el funcionamiento del puente, dentro de los cuales se mencionan:

- a) **Superficie de rodamiento:** La capa soportante de las cargas aplicadas por el tráfico, la cual puede ser de pavimentos rígidos o flexibles de espesores variables los cuales se recomienda se mantengan entre los 2.54cm y 5cm.
- b) **Barandas:** Son estructuras instaladas en los costados del puente de forma longitudinal con el fin de evitar la caída de alguno de los usuarios del puente.
- c) **Juntas de expansión:** Estos elementos son utilizados para permitir la traslación y/o rotación del puente, además de separar fragmentos del mismo. Existen diferentes tipos de juntas dependiendo del tipo de puente.

Superestructura

El BIRM (Bridge Inspector’s Reference Manual) (2012) de AASHTO menciona que la superestructura tiene el propósito de transferir las cargas de tránsito a las cuales se expone el puente hacia la subestructura, mediante elementos como vigas, armaduras, cables, arcos, diafragmas y apoyos secundarios entre otros. El MOPT (2007) menciona los siguientes tipos de super estructura:

- a) **Superestructura de viga:** Se cataloga por la viga utilizada y si es simple o continua, dentro de las cuales se enmarcan la viga I, T y de cajón y las que conforman un marco rígido.
- b) **Superestructura de cercha:** Se utiliza mediante la unión de dos armaduras que se unen mediante el piso, diafragmas y sistemas de arriostres. Este tipo de super estructura se subdivide según la ubicación

de las armaduras en superior, media e inferior.

- c) **Superestructura de Arco:** Son estructuras las cuales mediante vigas o armaduras forman arcos los cuales se someten a esfuerzos de compresión pura, y se subdividen según la ubicación del arco en superior, media o inferior.
- d) **Superestructura Suspendida:** Estos se subclasifican en colgantes y atirantados en donde la mayor diferencia es que en el primero existe una línea principal que une las torres principales, mientras que el otro utiliza líneas para unir ciertos puntos importantes a la torre.

De igual forma el MOPT (2007) menciona que cada superestructura cuenta con los siguientes elementos:

- a) **Sistema de piso:** Elemento que transfiere las cargas de tránsito a los elementos principales, normalmente se cataloga como losa, y puede ser construida en acero, concreto, madera y otros.
- b) **Elementos Principales:** Soportan las cargas de uso del puente y las transmiten a la subestructura dentro de ellas están las vigas principales longitudinales.
- c) **Elementos Secundarios:** Estos elementos redistribuyen las cargas con el fin de hacer más eficiente la estructura, como por ejemplo los elementos diafragma y las vigas secundarias.

Subestructura

El MBE (2018) define la subestructura como los elementos encargados de transferir las cargas de la superestructura a el suelo, y el cual comienza con los apoyos de la superestructura, esto mediante los apoyos, pilas, pilotes entre otros. Es así como como el MIP (2007) clasifica lo siguiente:

- a) **Apoyos:** Se encargan de transmitir cargas verticales entre la super y la subestructura, también permite ofrecer

cierta libertad en traslación y rotación según sea el diseño, los apoyos varían según el tipo de puente dentro de los que existen apoyos de expansión de rodillo, expansión de patín, apoyos fijos de acero y los apoyos rígidos.

- b) **Bastiones:** Este funciona absorbiendo los empujes de terreno en los extremos de la superestructura. Existen diferentes tipos de bastiones como de gravedad, voladizo, de marco, con contrafuertes, cabezal sobre pilotes y de tierra armadas. También varían según el tipo de fundación, los cuales pueden tener fundaciones superficiales las cuales se apoyan en una placa que transmite la presión al terreno directamente o las fundaciones profundas que utilizan elementos como fosos y pilotes para transmitir las cargas a sustratos inferiores.

En general los bastiones poseen los siguientes elementos mostrados en la figura 2.



Figura 2. Elementos de un Bastión. Fuente: MOPT (2007).

- c) **Pilas:** Según el MOPT (2007) estos elementos son apoyos intermedios los cuales son formados por casi los mismos elementos que los bastiones, eliminando los aletones, las pilas pueden ser de tipo muro, marco, de columna sencilla y columna múltiple, los cuales normalmente son construidos en concreto, pero pueden

fabricarse en materiales como acero y madera.

- d) **Accesos de aproximación:** El MIP (2007) indica que son elementos (principalmente losas) que permiten la unión de trasado natural al puente y prevenir asentamientos de los rellenos de aproximación, estos se apoyan en la ménsula de la viga cabezal del bastión.

Para la evaluación de puentes se han creado múltiples manuales los cuales permiten generar uniformidad de criterios en la evaluación de puentes, algunos de los más comunes se muestran a continuación:

Manuales Técnicos

1. **Manual de Inspección de Puentes del MOPT:** Este es el documento oficial en Costa Rica el cual fue publicado en el año 2007 y tuvo una modificación en el año 2014. Este documento es nombrado por sus siglas MIP.



Figura 3: Manual de Inspección de puentes.
Fuente: MOPT (2007)

2. **The Manual for Bridge Evaluation:** Este Manual de la AASHTO publicado en 2018,

presenta pruebas de evaluación más avanzadas según el tipo de puente en estudio.



Figura 4: Manual de evaluación de Puentes.
Fuente: AASHTO (2018)

3. **LRFD Bridge Design Specifications:** Este documento es el último código LRFD publicado por la AASHTO y sustituye al 2017, este documento es el que incluye más elementos para el diseño y evaluación de puentes.

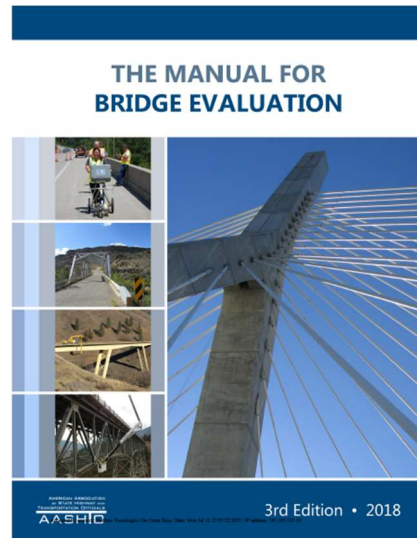

Figura 5: LRFD Bridge design Specifications
Fuente: AASHTO (2020)

4. **LRFD Desing for Higway Bridge Superstructures:** Este documento está basado en el LRFD de AASHTO posee una explicación más extensa de los principales tipos de puentes utilizados normalmente, con principal atención a la super estructura, lo que permite tener explicaciones más profundas de algunos elementos.

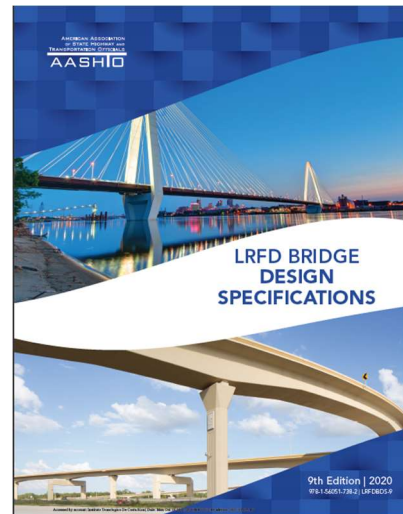

Figura 6: Manual de referencia del Inspector de Puentes Fuente: FHWA (2015)

5. **Bridge Inspector's Reference Manual:** Este documento de la NHI (National Highway Institute) se creó con el fin de brindar mejores parámetros a los inspectores de cómo utilizar las estrategias de evaluación de puentes más usadas.

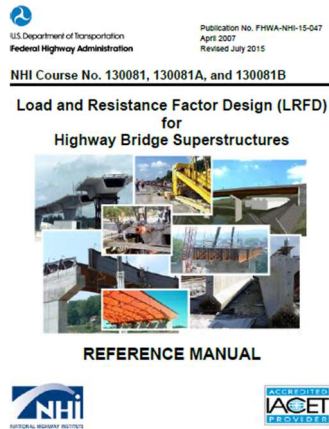

Figura 7: Bridge Inspector Reference Manual. Fuente: NHI (2012)

6. **ACI318-19** toma relevancia en puentes como el presente construido con elementos de concreto, pues algunos aspectos de diseño son redirigidos a este libro por parte del AASHTO LRFD con el fin de homologar diseños y no realizar la repetición de conceptos.

Figura 7 ACI-318

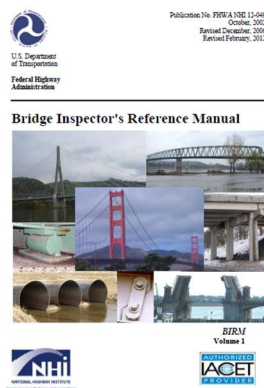

Figura 8: ACI 318-19. Fuente: ACI (2019)

Vehículo Tipo

El vehículo a utilizar para la movilización de los equipos de carga especial ya está definido, lo que limitó a su vez la carga máxima por analizar según el interés del ICE. Según la información brindada por la subárea de gestión de flota-área de planificación y adquisición de vehículos, la carga máxima de arrastre del camión sería de 120 toneladas incluyendo la carga y el remolque, todo lo anterior con un desplazamiento constante de 10 km/h con la vía cerrada. A continuación, sobre el puente, se adjunta un diagrama del vehículo tipo.

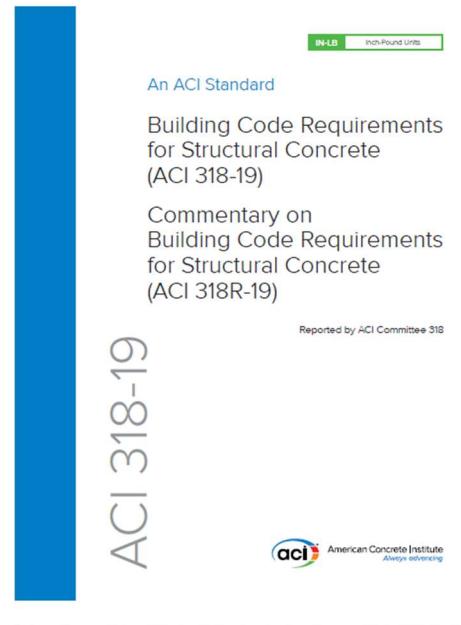

Figura 9: Vehículo de Transporte. Fuente: ICE (2021)

Software

CSI BRIDGE

Este software de Computers and Structures Inc es un programa de elemento finito que integra una serie de elementos que facilitan el diseño y análisis de distintos tipos de puentes incluyendo desde la secuencia constructiva, cálculo de deformaciones, esfuerzos, desplazamientos, hasta pandeos, dimensionado todo utilizando la normativa internacional más importante CSI (2021), cabe recalcar que este programa incluye incluso información del CSCR 2010 con la actividad sísmica de Costa Rica, según zonas y tipos de suelos.

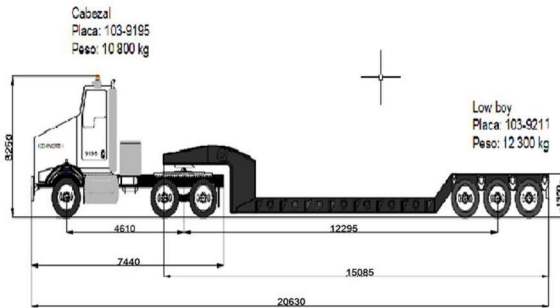
Esfuerzos

Axiales

Según Feandalucia (2008) son esfuerzos que tienden sea a elongar o reducir un elemento en el sentido de aplicación de fuerza, según si son tensionantes (las fuerzas actúan hacia afuera del elemento) o de compresión (actúan sobre el

elemento en el mismo sentido) son esfuerzos presentes en casi todos los elementos. El concreto posee una alta capacidad a la compresión, pero en general su capacidad a la tensión se desprecia.

En el caso de las columnas se realiza la comprobación de la capacidad a compresión de la sección, en donde se tiene que:

$$P_n = 0.85f'_c(A_g - A_{st}) + A_s f_y$$

Fuente: ACI 318 (2019) Eq: 22.4.2.2

Cabe mencionar que al igual que en otras ecuaciones mostradas a continuación se utilizan algunas provenientes del ACI 318-19 esto pues el AASHTO (2020) referencia algunas de las formas de cálculo a otros documentos especializados en cada tipo de elemento, parte del esfuerzo por homogenizar algunos procesos de diseño.

Flexión

Estos esfuerzos según Feandalucia (2008) son generados producto de la combinación de fuerzas comprensivas en las fibras de un área del elemento y fuerzas tensionantes en las fibras del área opuesta separadas por un punto en el cual las fibras no se comprimen ni se tensan llamado eje neutro, por ejemplo, en una viga rectangular en la cual las fibras de la parte superior están siendo comprimidas y las de la cara inferior están siendo elongadas, se provoca que este elemento tienda a doblarse.

Estos efectos toman particular importancia en la superestructura de los puentes en donde producto de la configuración del puente tiende a acrecentarse, en el caso de elementos de concreto el cálculo de la capacidad se realiza primero analizando la geometría de elementos, y luego aplicando las ecuaciones pertinentes.

En caso de las vigas de este puente se determinó que las mismas pueden analizarse como vigas compuestas tipo T en donde se realiza el análisis del bloque de compresión:

$$a = \frac{A_{ps}F_{ps} + A_sF_y - A'sf's - 0.85f'c h_f(b - b_w)}{0.85f'c \times b_w}$$

Fuente: AASHTO (2020) Eq : 5.6.1.2.3

Para así después evaluar la capacidad de momento flector de la viga, para esto se utilizan la ecuación brindada por AASHTO (2020):

$$M_n = A_{ps}f_{ps} \left(d_p - \frac{a}{2} \right) + A_s f_s \left(d_s - \frac{a}{2} \right) - A's f' \left(d'_s - \frac{a}{2} \right) + \alpha_1 f'_c (b - b_w) h_f \left(\frac{a}{2} - \frac{h_f}{2} \right)$$

Fuente: AASHTO (2020)

Una vez que se obtiene la capacidad nominal se aplica un factor de reducción igual a 0.9 según indica AASHTO (2020) siguiendo la metodología LRFD, en donde después se verifica que:

$$\mu / (M_n \cdot \Phi) < 1$$

Si el valor anterior es inferior a 1 significa que la capacidad del elemento es mayor al momento último que será aplicado según la combinación evaluación elegida.

La flexión en columnas es limitada por las fuerzas axiales, en el caso de elementos de concreto reforzado el ACI318-19 posee un proceso de diseño en el cual se calculan o se infieren bloques de compresión, según en los que se divide las secciones de acuerdo con su ubicación y así será su aporte en donde si estos cambian su orientación de momento, según los obtenidos en el cálculo del bloque balanceado estos realizan una disminución de capacidad del momento, siguiendo una ecuación similar a la de compresión pero multiplicando cada valor por su brazo de palanca, obteniéndose la siguiente ecuación:

$$P = 0.85f'cAc_{dc} + A_s f_y \times d_s + A's f's \times d's$$

Fuente: ACI:318-19

Cortantes

Estos esfuerzos también llamados efectos de cizalladura, se generan según Feandalucia (2008) cuando existen fuerzas perpendiculares en un elemento por lo cual el elemento genera fuerzas opuestas, de forma que si se supera el umbral máximo existe una separación del elemento en 2 partes.

En elementos de concreto ACI (2019) menciona que pueden darse cortantes generados por los esfuerzos flexocortantes tienden a ser más pequeños y se distribuyen en más áreas de los elementos en el caso de las vigas T puede considerarse aportes de las alas a la capacidad del mismo, y el cortante en el alma el cual normalmente ocurre tal cual su nombre en el alma de la viga. Para el último tipo de cortante se realiza el cálculo suponiendo que la fractura se realizará en un ángulo de 45°.

La capacidad nominal de cortante en elementos de concreto está influida por la sumatoria del aporte del concreto, el acero y si existe la fuerza vertical generada por los presfuerzos. En el caso del acero se calcula de la siguiente forma:

$$V_s = \frac{A_v f_y d_v}{s}$$

Fuente: AASHTO (2020) Eq 5.7.3.3.1

El aporte del concreto se presenta para elementos no presfuerzados utilizando la siguiente ecuación:

$$V_c = bd(2\sqrt{f'c} + \frac{Nu}{6Ag})$$

Para el caso de los miembros con presfuerzos se utiliza la ecuación:

$$V_c = bd(0.16\sqrt{f'c} + 49)$$

Cabe mencionar que el Instituto de Ingeniería de la UNAM (2000) mencionó que esta ecuación realiza un cálculo muy conservador de la capacidad del elemento.

En el caso de revisiones de cortantes en puentes AASHTO (2020) recomienda utilizar un factor de reducción igual a 0.75.

Torsión

Feandalucia (2008) menciona que estos esfuerzos se generan por medio de la existencia de rotaciones dentro del propio elemento en el eje longitudinal del puente, generando un efecto similar al que se da cuando se gira un trozo de tela para eliminar el exceso de agua en él. En puentes generalmente se generan por la presencia asimétrica de tráfico y embotellamientos, o por diseños asimétricos de los puentes.

Presfuerzos

Estos esfuerzos son intensionales y se constituyen en una forma constructiva. Según Vidaud (2009) esta práctica reduce el agrietamiento, aumenta la flexibilidad en los elementos, permite ahorrar acero, y de las propiedades más importantes en puentes es que se aumenta la durabilidad de los elementos y permite la construcción de claros más grandes sin elevar el tamaño de los elementos. La aplicación de estos esfuerzos intensionales se realiza mediante 2 métodos, el primero en el que se tensan los cables antes de la colocación del concreto llamado preesforzado, el segundo de nombre postensado es en el que como su nombre lo dice el tensado de los cables se realiza después del fraguado del concreto.

Cuando se diseñan elementos presforzados debe considerarse que los cables tendrán pérdidas en su fuerza, estas pérdidas según AASHTO (2020) son por la fricción con los conductos, relajación del acero, pérdidas en los anclajes de fijación y las producidas en el proceso de aplicación, a la suma de las pérdidas anteriores se le llama pérdidas totales del presfuerzo y son

aplicables a concretos con resistencias menores a los 1050kg/cm². Las pérdidas pueden fluctuar entre el 10% y el 20% de la fuerza aplicada en el tendón según el autor consultado, AASHTO (2020) las pérdidas totales se encuentran normalmente dentro del 20% valor que se utilizará para los cálculos en este documento.

Combinación de cargas

Según sea el proceso el cual se realice AASHTO (2020) permite utilizar diferentes combinaciones de mayoración de carga, en donde en un proceso deben valorarse si el elemento es o no parte del sistema sismorresistente. En el caso de evaluaciones sin sismo para diseño debe utilizarse la combinación de fuerza 1 de AASHTO LRFD (2020), la cual se muestra a continuación:

$$LC1 = 1.25CM + 1.5DW + 1.75CV + 1TU + 1EV$$

Para evaluar estructuras existentes AASHTO (2020) brinda la combinación de fuerza 2, esta se utiliza para evaluar el comportamiento de puentes ante el paso de vehículos especiales a petición del dueño o interesado con el fin de evaluar los permisos de paso, esto en condiciones sin viento:

$$LC2 = 1.25CM + 1.25DW + 1.35CV + 1TU + 1EV$$

Para realizar las evaluaciones de deflexiones se utiliza una combinación la cual no posee factores de mayoración:

$$LCX = 1CM + 1DW + 1CV + 1TU + 1EV$$

Para evaluaciones de vehículos en servicio AASHTO (2020) brinda la combinación de servicio 1 la cual utiliza una combinación la cual no posee factores de mayoración, solo se mayor la carga, como se muestra a continuación:

$$LCX = 1CM + 1DW + 1.35CV + 1TU + 1EV + 1V$$

Las ecuaciones anteriores con:

CM: Carga Muerta

DW: Capas de Asfalto

CV: Carga Viva

TU: Cargas de Pretensión

EV: Cargas verticales de agregados

V: Carga de Viento

Metodología

En relación con el objetivo de establecer la seguridad del puente sobre el río Sucio para el paso de equipos de peso especial se define la guía de trabajo la cual está enfocada en 2 áreas de trabajo, la primera se refiere a la condición actual del puente por medio de las revisiones visuales, la otra área de trabajo se dirige al análisis de la capacidad estructural teórica de los elementos del puente. Por lo tanto, se estableció la siguiente metodología para el trabajo.

Estudio Bibliográfico

Se realizó un análisis de la literatura existente acerca de puentes con el fin de reunir el conocimiento teórico el cual permitiese definir el marco de evaluación del puente y su posterior análisis para avalar la carga máxima a trasladar por la estructura. Se revisó la normativa mencionada en el marco teórico, también se

revisaron documentos preparados por instituciones como Lanamme, y el CIVCO, también se revisaron las inspecciones visuales anteriores, la otra área de trabajo se centró en analizar la capacidad estructural teórica de los elementos del puente.

Inspección

Se utilizaron los formularios existentes para la inspección visual elaborados por el MOPT y se realizó una adaptación que facilite el análisis de la información obtenida según los materiales y tipo de puente en cuestión. Se utilizó la inspección visual realizada por el CIVCO en el año 2015 con el fin de establecer un parámetro de daño del puente, en el momento que se desee realizar el tránsito de cargas por este sitio deberá ser comprobado con el fin de que el daño no haya aumentado de forma importante. Dichos formularios se presentan a continuación:

Cuadro 1. Formulario Información General		
Formulario 0	Información General	
ITEM	Sección	Descripción
Tipo de Ruta	5.2.1	Nacional o cantonal
Nombre	5.2.2	Nombre del río, quebrada o estructura asignado
Versión	5.2.3	Generada por SAEP
Ruta	5.2.4	Primaria, secundaria, terciaria o cantonal Tabla 5-1 (MIP, 2014)
Numero Ruta	5.2.5	Número de ruta en el que se ubica
Kilometro	5.2.6	Kilómetro de inicio
Localización	5.2.7	Provincia, cantón, distrito
Encargado	5.2.8	Zonas según CONAVI anexo 1 (MIP, 2014)
Sección de Control	5.2.9	Número brindado por la dirección de planificación del MOPT para rutas nacionales
Código de Puente	5.2.10	Número brindado por la dirección de Planificación del MOPT
Latitud Norte y Longitud Oeste	5.2.11	Coordenadas del puente
Fecha de Diseño	5.2.12	Fecha en que fue diseñado
Fecha de Construcción	5.2.13	Fecha de finalización de construcción

Cuadro 2. Formulario 1		
FORMULARIO 1	Inventario básico del puente	
Ítem	Sección	Descripción
Dirección de Vía	5.3.1	Lugar al que se dirige
Tipo de Estructura	5.3.2	Tipo de estructura en estudio (Tabla 5.4 (MIP, 2014))
Carga Viva	5.3.3	Carga para el que se diseñó (Tabla 5.5 (MIT, 2014))
Longitud Total	5.3.4	Suma de la longitud de todos los tramos longitudinales para puentes, y longitud afectada en el caso de alcantarillas
Especificación	5.3.5	Normativa de diseño utilizada
Numero de Superestructuras	5.3.6	Número de tramos de la estructura, o estructuras separadas por juntas de expansión Anexo 2 (MIP, 2014)
Numero de Subestructuras	5.3.7	Cantidad total de Bastiones y Pilas del Puente Anexo 2 (MIP,2014)
Número de Tramos	5.3.8	Número de Tramos en los que se divide el Puente Anexo 2 (MIP,2014)
Longitud de desvío	5.3.9	Distancia que se recorrería para llegar al destino en caso de cierre del puente
Pendiente Longitudinal	5.3.10	Porcentaje de inclinación longitudinal del puente
Servicios Públicos	5.3.11	Tipos de servicios los cuales tengan tuberías o conductos en el puente Tabla5-7 (MIP, 2014)
Cruza Sobre	5.3.12	Nombre del río o estructura sobre o debajo de la cual atraviesa
Tipo de Pavimento y Espesor	5.3.13	Tipo de pavimento y espesor de la superficie de rodamiento Tabla 5-8 (MIP, 2014)
Conteo de trafico	5.3.14	Total del último conteo diario de tráfico realizado en el lugar.
Restricciones	5.3.15	Anotar restricciones de peso, altura etc existentes en el puente
Ancho del Puente	5.3.16	Anchos entre elementos externos de la sección transversal
Ancho de Calzada	5.3.16	Distancia interna entre cordones de caño
Altura Libre Vertical Superior	5.3.16	Altura entre la rasante y el elemento estructural de mayor altura
Altura Libre Vertical Inferior	5.3.16	Altura entre la parte inferior de la viga de mayor peralte y el nivel de superficie bajo el puente
Ancho de via de acceso	5.3.16	Espacio destinado a las rampas de acceso

Cuadro 3. Formulario 2		
Formulario 2	Inventario básico del puente - Detalle de superestructura	
Ítem	Sección	Descripción
Número de Superestructura	5.4.1	Número de tramos de la estructura, o estructuras separadas por juntas de expansión Anexo 2 (MIP, 2014)
Número de Tramos	5.4.2	Número de Tramos en los que se divide el Puente Anexo 2 (MIP, 2014)
Alineación de Planta	5.4.3	Recto, sesgado o curvo Tabla 5-9 (MIP, 2014)
Material de Viga Principal	5.4.4	Material en el que se construyó Tabla 5-10 (MIP. 2014)
Superestructura	5.4.5	Ofrecer el tipo de superestructura según la tabla 5-11 del MIP (2014)
Tipo de Viga Longitudinal	5.4.6	Tipo de Viga según Tabla 5-12 del MIP (2014)
Longitud Total	5.4.7	Longitud Total en Metros de la superestructura
Longitud de Tramo Máximo	5.4.8	Longitud del Tramo Máximo de la Super Estructura
Número de Vigas	5.4.9	Cantidad de Vigas Longitudinales Principales que conforman la estructura
Espaciamiento de vigas	5.4.10	Separación entre ejes centrales longitudinales de las vigas principales
Altura de viga	5.4.11	Altura de vigas Principales, sin contar la losa en los casos que estén directamente unidos
Tipo de Junta de expansión	5.4.12	Tipo de Junta de expansión en las ubicaciones según la Tabla 5-13 del MIP (2014)
Material de Losa	5.4.13	Material con el que fue construido la losa según la Tabla 5-14 del MIP (2014)
Espesor de Losa	5.4.14	Espesor de la losa soportante construida

Cuadro 4. Formulario 3		
Formulario 3	Inventario Básico del Puente - Subestructura	
Ítem	Sección	Descripción
Numero de Subestructura	5.5.1	Número de identificación de Subestructura según Anexo 2 (MIP, 2014)
Nombre	5.5.2	Nombre de la subestructura según el Anexo 2 del MIP 2014
Materiales	5.5.3	Materiales en los que son construidos los bastiones y las pilas según la tabla 5-16 MIP (2014)
Tipo	5.5.4	Tipo de Bastión según la tabla 5-17 del MIP (2014)
Altura	5.5.5	Altura de los bastiones y la pila
Pila	5.5.6	Tipo de Pila según la tabla 5-18 del MIP (2014)
Ancho y Largo	5.5.7	Ancho y largo de los bastiones y pilas
Tipo Fundación	5.5.8	Tipo de Fundación según tabla 5-19 del MIP (2014)
Ancho y Largo de Fundación	5.5.9	Ancho y largo de las fundaciones.
Tipo de Pilotes	5.5.10	Tipo de Pilotes según la tabla 5-20 del MIP (2014)
Tipo de Apoyo	5.5.11	Tipo de apoyo según tabla 5-21 del MIP (2014)
Ancho de Asiento	5.5.12	Distancia de apoyo entre bordes exteriores de viga longitudinal y viga cabezal

Cuadro 5. Formulario 4		
Formulario 4	Inventario Básico del Puente - Fotografías	
Fotografías Básicas	Sección	Descripción
Rotulo del Puente	3.4	FOTO
Vista a lo largo de la línea centro	3.4	FOTO
Perspectiva de todo el puente	3.4	FOTO
Vista Lateral	3.4	FOTO
Vista Inferior	3.4	FOTO
Vista del cauce del rio	3.4	FOTO
Vista de la subestructura	3.4	FOTO
Vista del elemento que cruza el Puente	3.4	FOTO
Señalización en Puente	3.4	FOTO
Losa	3.4	FOTO
Viga Principal	3.4	FOTO
Bastiones	3.4	FOTO
Pilas	3.4	FOTO
Apoyos	3.4	FOTO
Juntas de Expansión	3.4	FOTO
Superficie Rodamiento	3.4	FOTO
Barandas	3.4	FOTO

Cuadro 6. Formulario 5		
Formulario 5	Inventario Básico del Puente - Planos	
Ítem	Sección	Descripción
Planos del Puente	5.8	Deben adjuntarse los planos existentes del puente.

Cuadro 7. Formulario 6							
Formulario 6							
Ítem	Sección	Tabla MIP (2007)	Calificación				
			1	2	3	4	5
Pavimento	6.1						
Ondulaciones	6.1.1	6-1					
Surcos	6.1.2	6-2					
Grietas en Superficie Rodamiento	6.1.3	6-3					
Baces	6.1.4	6-4					
Sobrecapas en Superficie Rodamiento	6.1.5	6-5					
Barandas	6.2						
Deformación	6.2.1	6-5-2					
Oxidación (acero)	6.2.2	6-6					
Corrosión (acero)	6.2.3	6-7					
Faltante o ausencia	6.2.4	6-8					
Agrietamiento (B. Concreto)	6.2.5	6-9					
Exposición de Acero (B.Concreto)	6.2.6	6-10					
Juntas de Expansión	6.3						
Sonidos Extraños	6.3.1	---					
Filtraciones de agua	6.3.2	6-11					
Faltante o Deformación	6.3.3	6-12					
Movimiento Vertical	6.3.4	6-13					
Juntas Obstruidas	6.3.5	6-14					
Acero de refuerzo expuesto en las juntas	6.3.6	6-10					
Losa	6.4						
Grietas en 1 dirección	6.4.1	6-15					
Grietas en 2 direcciones	6.4.2	6-16					
Descascaramiento	6.4.3	6-17					
Exposición de Acero	6.4.4	6-10					
Nidos de Piedra	6.4.5	6-18					
Eflorescencia en la losa de Concreto	6.4.6	6-19					
Agujeros en la losa de concreto	6.4.7	6-20					
Viga Principal de Concreto	6.8						

Grietas en una dirección	6.8.1	6-34							
Grietas en dos direcciones	6.8.2	6-35							
Descascaramiento	6.8.3	6-17							
Acero de refuerzo expuesto	6.8.4	6-10							
Nidos de Piedra y Cavidades	6.8.5	6-18							
Eflorescencia	6.8.6	6-19							
Viga Diafragma	6.9								
Grietas en una dirección	6.9.1	6-34							
Grietas en dos direcciones	6.9.2	6-35							
Descascaramiento	6.9.3	6-17							
Acero de refuerzo expuesto	6.9.4	6-10							
Nidos de Piedra y Cavidades	6.9.5	6-18							
Eflorescencia	6.9.6	6-19							
Apoyos del puente	6.1								
Rotura de Pernos	6.10.1	6-37							
Deformación	6.10.2	6-38							
Inclinación	6.10.3	6-39							
Desplazamientos	6.10.4	6-40							
Viga Cabezal y Aleton de Bastión	6.11								
Grietas en una dirección	6.11.1	6-34							
Grietas en dos direcciones	6.11.2	6-35							
Descascaramiento	6.11.3	6-17							
Acero de refuerzo expuesto	6.11.4	6-10							
Nidos de Piedra y Cavidades	6.11.5	6-18							
Eflorescencia	6.11.6	6-19							
Protección de Talud	6.11.7	6-41							
Cuerpo Principal del Bastión	6.12								
Grietas en una dirección	6.12.1	6-34							
Grietas en dos direcciones	6.12.2	6-35							
Descascaramiento	6.12.3	6-17							
Acero de refuerzo expuesto	6.12.4	6-10							
Nidos de Piedra y Cavidades	6.12.5	6-18							
Eflorescencia	6.12.6	6-19							
Perdida de talud de protección en frente del Bastión	6.12.7	6-42							
Inclinación	6.12.8	6-43							
Socavación en la fundación	6.12.9	6-44							
Martillo de la pila	6.13								
Grietas en una dirección	6.13.1	6-34							
Grietas en dos direcciones	6.13.2	6-35							

Descascaramiento	6.13.3	6-17							
Acero de refuerzo expuesto	6.13.4	6-10							
Nidos de Piedra y Cavidades	6.13.5	6-18							
Eflorescencia	6.13.6	6-19							
Cuerpo Principal de Pila	6.14								
Grietas en una dirección	6.14.1	6-34							
Grietas en dos direcciones	6.14.2	6-35							
Descascaramiento	6.14.3	6-17							
Acero de refuerzo expuesto	6.14.4	6-10							
Nidos de Piedra y Cavidades	6.14.5	6-18							
Eflorescencia	6.14.6	6-19							
Inclinación	6.14.7	---							
Socavación en la fundación	6.14.8	6-45							

Una vez obtenidos los resultados de la inspección visual realizada por CIVCO, y la aplicación de los formularios se realizó una suma sencilla por cada una de las áreas y se dividen entre los ítems a evaluar con el fin de obtener el promedio por área de cada sección de la estructura, posteriormente se utilizó el criterio de evaluación de desempeño estructural de Ortiz et al (2019), esta selección está ligada directamente al MIP, el mismo consiste en agrupar la condición del puente en la siguiente fórmula:

Ecuación 1: Fórmula Condición Estructural del Puente

$$BCI = 5\% \text{ Accesorios} + 45\% \text{ Superestructura} + 50\% \text{ Subestructura}$$

Fuente: Ortiz et al (2019)

Con lo cual se multiplicaron los valores promedio de cada una de las secciones evaluadas por su valor en el BCI con el fin de obtener un valor general del estado del puente. El ponderado total de la estructura se compara contra un parámetro de daño establecido por la metodología BCI en donde se muestra en valores del 1 a 5, si se obtienen valores <2 la condición es satisfactoria, entre 2 y 3 aceptable, el rango de 3 a 4 insatisfactoria y la condición deficiente corresponde a la calificación de 4 a 5 tal y como se muestra en la figura 6 a continuación:



Figura 10: Escala Evaluación BCI. Fuente: Ortiz et al (2019)

Para el presente informe no fue necesario la aplicación de los otros indicadores propuestos por Ortiz et al (2019) como lo son el indicador de riesgo de variables ambientales, el indicador de uso y el factor de importancia económica, pues este documento tuvo como único interés la determinación de la capacidad estructural del puente para el paso de una carga especial.

Antecedentes

Se realizaron 3 estudios importantes:

- 1- El primero titulado “El estudio sobre el desarrollo de capacidad en la planificación de rehabilitación mantenimiento y administración de puentes basado en 29

puentes de la red de carreteras nacionales en Costa Rica” (2007) realizado por JICA-MOPT, menciona que esta estructura posee una deformación anormal en la viga cajón, además agregan que es probable que la deflexión fuese causada por un diseño deficiente y fallas constructiva, la deflexión de más de 27cm se presenta en el claro número 2, el cual es de 102m de luz, en la figura 11 se presentan 3 líneas, en la línea continua casi horizontal analizaron la posibilidad de que esta

variación fuese realizada por la pérdida de preesfuerzos, la línea punteada permite observar variaciones generadas por pérdidas de esfuerzos en la construcción y finalmente la variación real en la parte más inferior expresa la deflexión real del puente, por lo cual establecieron que las deflexiones reales del puente son producto de una combinación de factores, desde el diseño y los materiales utilizados, hasta malas prácticas constructivas.



Figura 11: Deflexiones Encontradas en el Puente. Fuente: JICA (2007)

También se menciona que el puente se construyó para una carga diseño HS20-44 +25% y que con el paso del tiempo los elementos de concreto han superado su capacidad prevista a la compresión, en donde el promedio en la viga principal aumentó cerca de 30kg/cm² de capacidad, también se mencionan detalles de los suelos del lugar en donde la pila 1 está sobre grandes bloques de roca y lava compactada mientras que la pila 2 se encuentra sobre grava y fragmentos de lava, y la longitud del asiento del puente es mayor a la recomendada por los estándares japoneses la cual se calcula con la siguiente fórmula:

$SE = 0.7 + 0.005L$, siendo SE la longitud del asiento y L la longitud del tramo.

En donde el puente sobre el río Sucio cuenta con un asiento de 1.5m mayor a 1m recomendado. Finalmente esperan que el puente se mantenga hasta el 2035 sin intervenciones importantes.

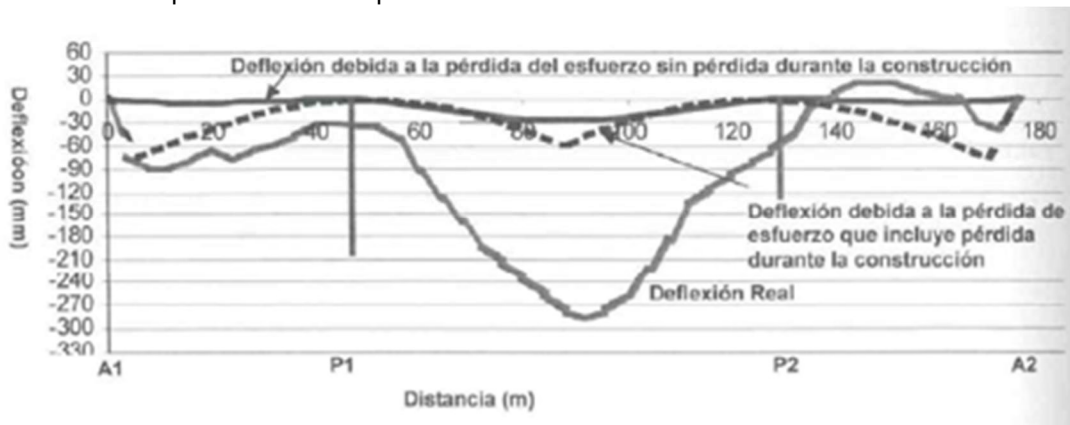
- 2- Evaluación de la vulnerabilidad ante amenazas naturales, ruta nacional 32 tramo San José – río Sucio: realizado por el Lanamme (2009) en donde se cataloga al puente con una clasificación HBR3 con un bajo riesgo sísmico en los próximos 100 años, siendo un factor importante para el presente estudio.
- 3- Informe de Inspección de Inventario Visual de daños en puentes: realizado en el año 2015 realizado por el programa ebridge de CIVCO, el cual mediante la inspección visual evalúa la estructura e identifica algunos problemas como que existen más de una sobrecapa en el puente, y algunos daños menores en la estructura, pero el mismo se encuentra en muy buen estado general.

Estudio de Planos

Se realizó el estudio de los planos del puente brindados por el MOPT en el Sistema de Administración de Estructuras de Puentes (SAEP), de donde se extraen 27 láminas las cuales se componen de 3 planos realizados en el 2007 por el acuerdo de cooperación JICA-MOPT y 24 planos realizados en el 2004 por Euro-Estudios MX los cuales se suponen como copias exactas de los originales del 1984. El MOPT indica que en teoría eran 34 láminas realizadas en México, pero únicamente posee 24 y se desconoce lo sucedido con los 10 restantes. Se destaca que los planos poseen varias inconsistencias, información la cual no está en los mismos que se mencionará más adelante.

Por medio de las láminas se determina el tipo de puente y los elementos que lo componen tanto características geométricas como de resistencia, características de los apoyos y variaciones paramétricas del puente.



Figura 12: Vista frontal Puente. Fuente: JICA-MOPT (2007)

Según la información extraída de los planos la estructura cuenta con diseño sismorresistente, es tipo cajón continuo de forma paramétrica en su eje principal, realizado con concreto preesforzado en la superestructura, y concreto reforzado en los demás elementos, cuenta de 3 tramos el primero de 55.25m, el segundo de 102m y el último de 30m de largo, se identifican 2 pilas, la primera de forma circular y la segunda de forma rectangular, ambas con geometría constante, colocadas al inicio de los tramos 2 y 3, además se identifica un bastión al inicio del tramo 1 el cual está apoyado

directamente en una plantilla de concreto pobre. Las cimentaciones consisten en 2 placas aisladas una bajo cada pila, la fundación de la pila 1, se ubica asentada a 15m bajo el nivel del suelo.

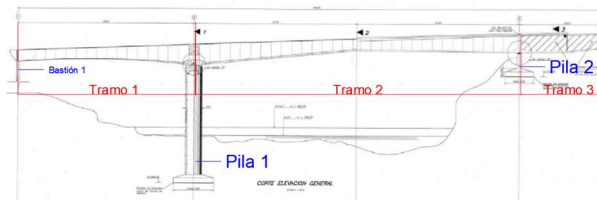

Figura 13: Diagrama Pila 1. Fuente: JICA-MOPT (2007)

La segunda pila se ubica a 5m bajo el nivel del suelo, ambas se ubican sobre una plantilla de concreto pobre de 10cm de espesor. El tramo 3 posee cerca de la mitad de su longitud asentado en una plantilla de concreto pobre rellena de piedras que funcionan como un contrapeso para la etapa constructiva.

Modelo del Software

Se realizaron varios modelos en el programa CSI Bridge con el fin de crear una referencia de los comportamientos del puente ante varios escenarios, aprovechando la versatilidad del programa, hasta definir el modelo final el cual es el utilizado en este documento.

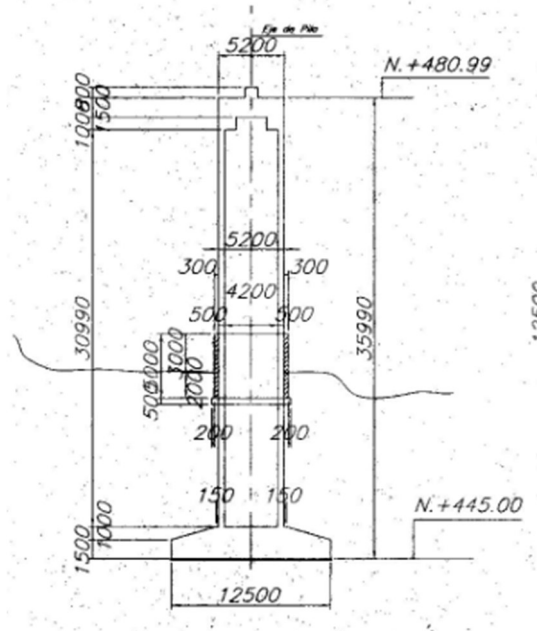
El modelo se realizó desde la pestaña inicio en blanco, a partir de donde se construyó el modelo en 3D a partir de los planos estructurales, como se mencionó anteriormente los planos no

estaban completos por lo que tuvieron que hacer algunas suposiciones como la cantidad de acero en las pilas en donde se tomó las cantidades mínimas indicadas para columnas de concreto reforzado según el ACI318-19..



Figura 14: Puente en Software. Fuente: Elaboración Propia

Para la realización del modelo computarizado se utilizaron los siguientes datos referentes a los materiales:

Cuadro 8. Características de Materiales		
Material	Peso (Kg/m3)	Resistencia (kg/cm2)
Concreto Vigas	2400	350
Concreto de las Pilas	2350	280
Concreto pobre	2300	145
Asfalto	2250	140

En cuanto a los módulos de elasticidad se trabajó con el recomendado para el acero el cual posee un valor de 2100000kg/cm², para el caso del concreto se calculó mediante la especificación ACI318-14:

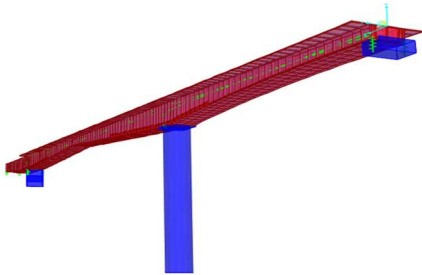
$$E_c = 15100\sqrt{f'_c}$$

En el caso del concreto el Módulo de Poisson se tomó como 0.2. La estructura está conformada por 2 tipos de sección de viga cajón; la primera presente en los primeros dos tramos la cual posee voladizos en ambos lados, y la segunda se encuentra en el tercer tramo no posee voladizos y es la utilizada con un contrapeso.

El primer tramo se realizó siguiendo una variación paramétrica de altura de tipo parabólica, mientras que el segundo y tercer tramo mediante

una variación lineal. Ambas según lo indicado en los planos.

Los cables de pretensión se modelaron según la especificación en planos, mediante la herramienta de tendones de presfuerzo del programa, los mismos ubicados en el alma de las vigas, aplicando una pérdida de fuerza en los cables de presfuerzos de un 20% según lo indicado por el AASHTO (2020) como las pérdidas totales normales. En el caso del acero de refuerzo se utilizó grado 60 de 4200kg/cm²

Cabe destacar que el programa permitió también realizar el modelado del vehículo tipo junto con la velocidad de desplazamiento y el impacto del mismo para obtener los datos necesarios. En este caso se utilizó el vehículo de máxima capacidad de transporte que posee el ICE a su máxima capacidad, con el fin de evaluar el mismo mientras se traslada a 10km/h, para lo que se evaluó el vehículo en movimiento según las fuerzas de cada llanta, no se tomaron en cuenta fuerzas distribuidas extra sobre el pavimento. Las fuerzas producto de frenado y la fricción del contrapeso no fueron tomadas en cuenta.

También fueron aplicadas al modelo las cargas lineales producto de las barandas, las cuales poseen un peso de 578kg/m. En el caso de las fuerzas distribuidas se utilizó:

Cuadro 9. Cargas de Área Extra	
Material	Peso (kg/m2)
Asfalto	340
Contrapeso	11000

En el caso de las cargas de viento se utilizó el modelo automático del programa según la normativa AASHTO LRFD 2018, con viento a velocidad sostenida de 70km/h.

Una vez con todos los datos ingresados se utilizó el programa con 4 combinaciones de carga, la combinación sin factores de mayoración, y las combinaciones de AASHTO (2020) fuerza 1, fuerza 2 y servicio 1.

Una vez finalizado el modelo se procede a la obtención y análisis de los resultados.

Análisis Numérico

Una vez obtenidos los datos del software se procedió a realizar el análisis de los datos, en donde se realizan los siguientes procedimientos.

Análisis de deflexiones en superestructura

Utilizando la combinación sin factores de mayoración se compararon las deflexiones obtenidas por el software a causa del paso del vehículo especial, las deflexiones de referencia de JICA-MOPT y las deflexiones de diseño, AASHTO propone como referencia una deflexión máxima de $L/800$ contra la longitud del tramo para el paso de cargas de diseño.

Análisis de Vigas

En el caso de las vigas se realizó el análisis idealizándolas como vigas T, en donde según el procedimiento normal debe verificarse que actúen de tal forma y no como una viga rectangular. Además, en la revisión la carga total aplicada total se divide entre 2 para así dividir entre las 2 vigas del cajón que se analizará.

Análisis de Flexión en Vigas

En este caso ya que la viga cajón es de sección variable se realizó la evaluación de puntos cada 5m según las fuerzas respectivas que actuaban sobre sí en cada sección, por lo cual se revisó que

el bloque de compresión para establecer las ecuaciones correctas a utilizar.

Cada una de las secciones analizadas son comparada contra los momentos mayorados mediante la combinación de fuerza 2 para verificar su cumplimiento

Análisis de Cortante en Vigas

El análisis de cortante fue realizado específicamente para el alma ya que es el área que resiste este esfuerzo directamente, para esto el cortante total de la sección se dividió entre 2 para dividirlo entre las 2 vigas principales que componen el cajón y así analizar las almas de forma independiente.

Análisis de Columnas por Flexo-Compresión

Para efectuar este análisis se consideraron primero los requerimientos para el análisis de flexo compresión de las pilas según columnas robustas de la metodología ACI318-19, después se realizó el cálculo de compresión pura, carga balanceada y puntos extra sobre y bajo la carga balanceada para obtener el diagrama, y verificar la capacidad.

Cortante de Columnas

El análisis de cortante en las pilas se realizó siguiendo el procedimiento de ACI318-19, evaluándolo únicamente en la sección superior de las pilas, esto porque el cortante es continuo en toda la sección la parte superior es la que posee una menor carga axial, por lo que si esta zona resiste el cortante la parte inferior también lo hará.

Análisis de bastión

El bastión se forma mediante una estructura compuesta de 2 columnas rectangulares y una viga cabezal sobre la cual descansa la estructura, la misma como se mencionó anteriormente. Se realizaron los cálculos de flexión y cortante para la viga, y una prueba de capacidad de compresión de las columnas.

Revisión Acciones Sísmicas

La sismicidad no fue analizada, esto por pedido del Instituto Costarricense de Electricidad, ya que se basa en la premisa de que la carga estará en el puente menos de 10 minutos, por lo tanto la probabilidad de darse un evento extremo en el momento en que la carga se encuentre en los puntos de mayor exigencia, es extremadamente baja, por lo que se decidió no contemplar ese aspecto del estudio.

Resultados

puede sobre el río Sucio en el 2015 se refleja en el resumen que se muestra en el cuadro 10:

Ítem	Área	Factor	Sub Total	%
1	Super estructura	0.45	1.473	0.66
2	Sub estructura	0.50	1.416	0.71
3	Accesorios	0.05	1.750	0.09
Total				1.46

INSPECCION VISUAL

Lo primeros resultados obtenidos son los respectivos a la condición visual del puente, esto mediante la última inspección realizada por el CIVCO en 2015. Cabe mencionar que cada vez que se desee utilizar el puente para este tipo de cargas extraordinarias debe hacerse una nueva inspección visual. La revisión visual realizada al

Además de los resultados presentes en los cuadros 10, 11, 12 y 13, existen otros resultados de la inspección visual que no tienen un impacto directo en la estructura, se encuentran en el apéndice 1.

Para ello se inicia con la evaluación de la superestructura, cabe recalcar que el CIVCO no realizó inspección visual de la parte interna de la viga cajón, únicamente de la externa como se presenta a continuación:

Ítem			Tabla	1	2	3	4	5	Sub Total
Juntas de Expansión		6.3							
1	Sonidos Extraños	6.3.1	---	1					1
2	Filtraciones de agua	6.3.2	6-11					5	5
3	Faltante o Deformación	6.3.3	6-12	1					1
4	Movimiento Vertical	6.3.4	6-13	1					1
5	Juntas Obstruidas	6.3.5	6-14	1					1
6	Acero de refuerzo expuesto en las juntas	6.3.6	6-10	1					1
Losa		6.4							
7	Grietas en 1 dirección	6.4.1	6-15	1					1
8	Grietas en 2 direcciones	6.4.2	6-16	1					1
9	Descascaramiento	6.4.3	6-17	1					1
10	Exposición de Acero	6.4.4	6-10	1					1
11	Nidos de Piedra	6.4.5	6-18	1					1
12	Eflorescencia en la losa de Concreto	6.4.6	6-19	1					1
13	Agujeros en la losa de concreto	6.4.7	6-20	1					1

Viga Principal de Concreto		6.8						
14	Grietas en una dirección	6.8.1	6-34		2			2
15	Grietas en dos direcciones	6.8.2	6-35	1				1
16	Descascaramiento	6.8.3	6-17	1				1
17	Acero de refuerzo expuesto	6.8.4	6-10			3		3
18	Nidos de Piedra y Cavidades	6.8.5	6-18		2			2
19	Eflorescencia	6.8.6	6-19		2			2
Total								1.47

De igual manera se analizó el estado de la superestructura del puente, la cual consta de 2 pilas y un bastión todo en concreto reforzado.

Cuadro 12. Subestructura									
Ítem			Tabla	1	2	3	4	5	Sub Total
Viga Cabezal y Aletón de Bastión		6.11							
1	Grietas en una dirección	6.11.1	6-34	1					1
2	Grietas en dos direcciones	6.11.2	6-35	1					1
3	Descascaramiento	6.11.3	6-17	1					1
4	Acero de refuerzo expuesto	6.11.4	6-10	1					1
5	Nidos de Piedra y Cavidades	6.11.5	6-18	1					1
6	Eflorescencia	6.11.6	6-19				4		4
7	Protección de Talud	6.11.7	6-41	1					1
Cuerpo Principal del Bastión		6.12							
8	Grietas en una dirección	6.12.1	6-34	1					1
9	Grietas en dos direcciones	6.12.2	6-35	1					1
10	Descascaramiento	6.12.3	6-17	1					1
11	Acero de refuerzo expuesto	6.12.4	6-10	1					1
12	Nidos de Piedra y Cavidades	6.12.5	6-18	1					1
13	Eflorescencia	6.12.6	6-19				4		4
14	Pérdida de talud de protección en frente del Bastión	6.12.7	6-42		3				3
15	Inclinación	6.12.8	6-43	1					1
16	Socavación en la fundación	6.12.9	6-44	1					1
Cuerpo Principal de Pila		6.14							
17	Grietas en una dirección	6.14.1	6-34	1					1
18	Grietas en dos direcciones	6.14.2	6-35	1					1
19	Descascaramiento	6.14.3	6-17	1					1
20	Acero de refuerzo expuesto	6.14.4	6-10	1					1
21	Nidos de Piedra y Cavidades	6.14.5	6-18		2				2

22	Eflorescencia	6.14.6	6-19		2				2
23	Inclinación	6.14.7	---	1					1
24	Socavación en la fundación	6.14.8	6-45	1					1
Total									1.42

Finalmente se realizó el análisis de los accesorios del puente, uno de los aspectos que permite deducir el mantenimiento de una estructura.

Cuadro 13. Accesorios									
Ítem			Tabla	1	2	3	4	5	Sub Total
Pavimento		6.1							
1	Ondulaciones	6.1.1	6-1	1					1
2	Surcos	6.1.2	6-2	1					1
3	Grietas en Superficie Rodamiento	6.1.3	6-3	1					1
4	Baces	6.1.4	6-4	1					1
5	Sobrecapas en Superficie Rodamiento	6.1.5	6-5					5	5
Barandas		6.2							
6	Faltante o ausencia	6.2.4	6-8	1					1
7	Agrietamiento (B. Concreto)	6.2.5	6-9	1					1
8	Exposición de Acero (B. Concreto)	6.2.6	6-10			3			3
Total									1.75

Modelado

Luego del análisis de la comprobación visual de la estructura realizada por el CIVCO se examinaron los planos con los cuales se hizo el modelo, utilizando el software CSI Bridge, a partir del cual se obtuvo el modelo base para generar el análisis estructural.



Figura 15: Vista Puente Modelado. Fuente: Elaboración Propia (CSiBridge)

Resultados Superestructura

Se realizó la comprobación de las deflexiones generadas por el puente y la carga sin mayorar, con lo cual como se observa en la gráfica 1, se obtienen las deflexiones máximas previstas por el modelo.

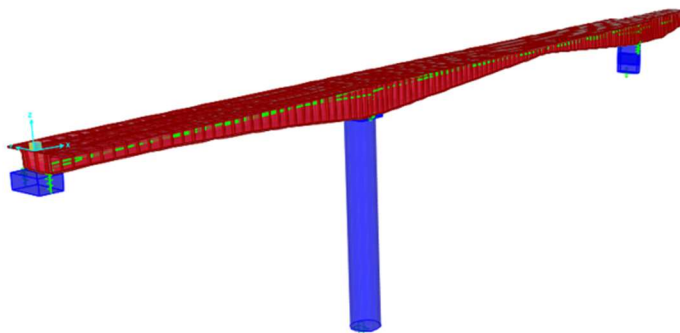
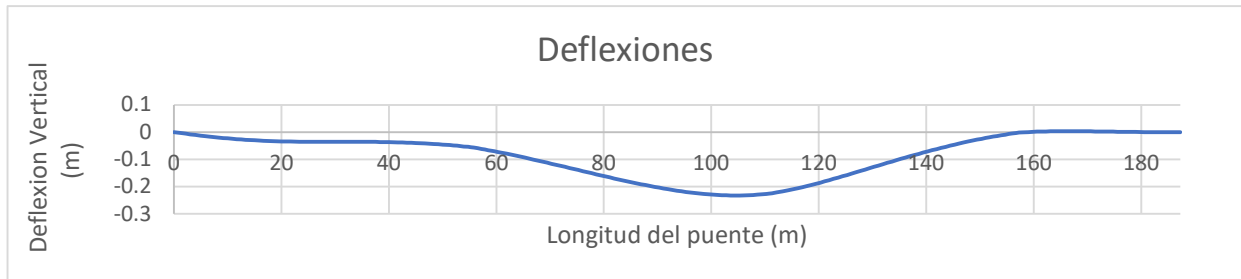

Gráfica 1. Deflexiones totales del modelo

Ya que desde el estudio JICA del puente se conocía sobre algunas deflexiones anormales, se realizaron algunas verificaciones extra según las cargas como se observa en la gráfica 2, también

se presentan las deflexiones por tramo generadas por el peso propio del puente y el vehículo de carga especial del ICE.

Tramo	Longitud Tramo (m)	Sugerido (m)	Real (m)	%
1	55.25	0.069	0.064	0.928
2	102.00	0.128	0.276	2.165
3	30.00	0.038	0.002	0.040

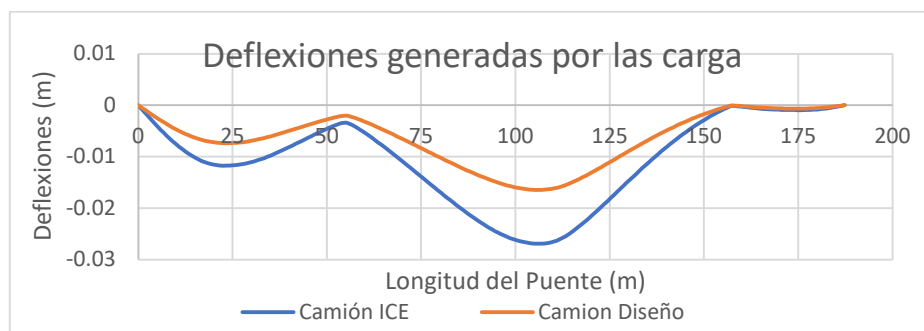

Gráfica 2. Comparación de deflexiones generadas por las cargas.

Las deflexiones anteriores se realizaron extrayendo las deflexiones únicamente generadas por el vehículo de diseño del puente el cual es AASHTO HS20-44 +25% con el fin de comparar las deflexiones para las que fue diseñado el puente y los generados por el paso de la carga esperada por el ICE en el vehículo de carga especial.

Una vez realizadas las deflexiones se continuo con el análisis de la superestructura. Se centró en el análisis de la viga cajón, para lo cual inicialmente con los datos brindados por el modelo

se realizaron las comprobaciones matemáticas, las cuales se presentan en el cuadro 15, cabe mencionar que se presentan únicamente como comprobación de la realización del procedimiento, más estos resultados fueron excluidos del presente estudio, porque los faltantes de información en los planos hacen que el cálculo de esta capacidad de forma directa no sea confiable, y suponiendo que se utilicen las cuantías mínimas de refuerzo como en el cuadro 15 no sería suficiente para que el diseño cumpla con los esfuerzos del elemento.

Cuadro 15. Capacidad a flexión			
Ubicación	$\Phi \times Mn$ (kg m)	Mu	$Mu/\Phi \times Mn$
0.00	813,036.14	9,810.00	0.02
20.00	904,938.03	1,445,400.00	1.59
40.00	1,444,546.40	4,584,824.00	3.17
55.25	2,505,299.12	12,786,977.50	5.10
80	1,237,094.89	2,065,549.00	1.66
100	756,226.62	5,671,181.00	7.49
120	870,392.54	3,293,562.00	3.78
157.25	2,505,299	18,276,769.00	7.29
187.25	1,064,432.38	9,848.00	0.01

Además, la revisión del modelo se realizó mediante la idealización de una viga compleja como lo es el tipo cajón en vigas T, de forma que se limita el apoyo que brindan las losas superiores e inferiores a la capacidad estructural del mismo puente, esto a razón de obtener un análisis externo de la estructura.

Otro aspecto analizado mediante la comparación con modelos de referencia realizados en el software, fue la elaboración de diferentes formas de apoyo al final del tramo 3, esto porque el programa no representa de forma exacta la condición de apoyo y la representación del contrapeso, por lo tanto, se encontró que no existe gran variación entre las formas de representación y los esfuerzos causados en la globalidad de la estructura, lo que obedece más a un factor de simpleza constructiva.

Ante los problemas en los planos que además de poseer láminas faltantes, no están detallados correctamente y existen puntos en donde se expresan secciones que no cumplen con las restricciones mínimas de AASHTO, sumado a que fueron realizados 20 años después de la construcción del puente, se tomó la precaución de examinar su fiabilidad y no tomarlos en cuenta, por lo cual se decidió utilizar la geometría mostrada, la cual sí se representa de forma correcta, y se realizaron las comprobaciones por medio de las cuantías mínimas de material, con el fin de obtener resultados más conservadores ante la imposibilidad de solicitar revisiones más profundas de los elementos para definir los datos faltantes.

Ya que los planos no necesariamente representan el diseño interno real de la viga en campo se procedió a realizar la comparación de la capacidad de esfuerzos de flexión para los cuales

se diseñó el puente inicialmente y se recalificó en el 2007 por el estudio JICA-MOPT por medio de los esfuerzos generados por la combinación fuerza 1 DE AASHTO la cual es la combinación de diseño y los esfuerzos previstos por el paso de la

carga especial, según la combinación de fuerza 2 de AASHTO y los esfuerzos de servicio con fuerzas de viento, los cuales se observan en las gráficas 3, 4 y 5.

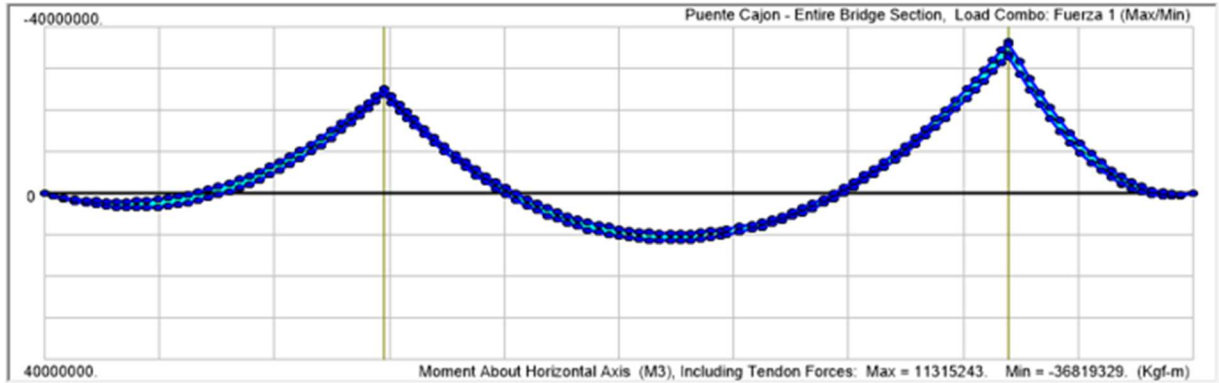

Grafica 3. Momentos generados con la combinación de diseño del puente y vehículo HS20-44+25%

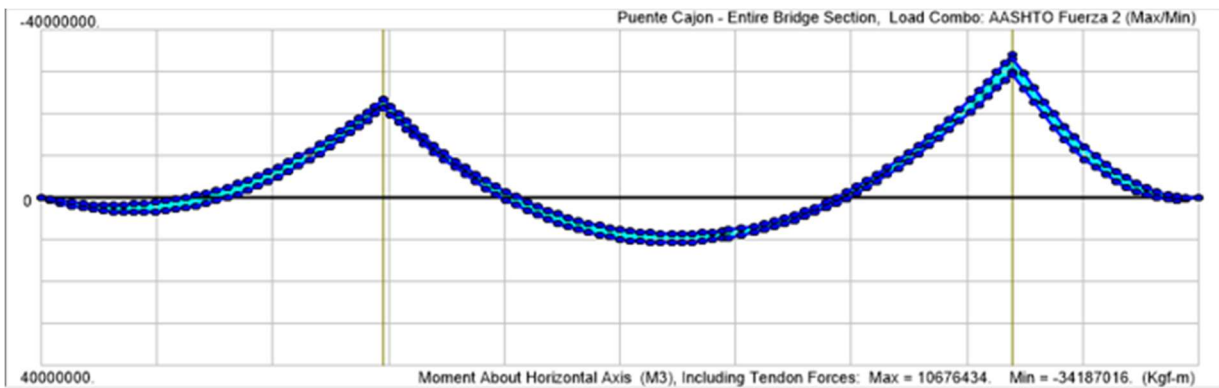

Grafica 4. Momentos generados por la prueba de carga especial (ICE)

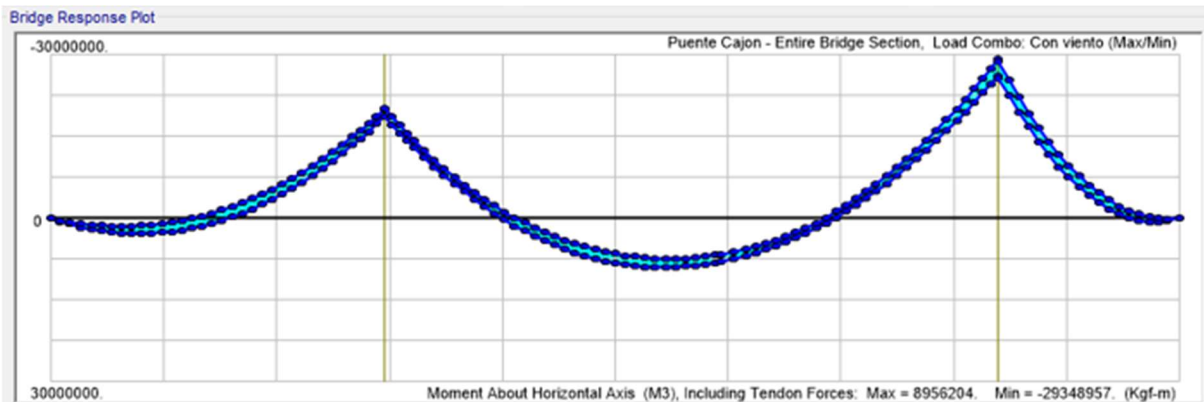

Grafica 5. Momentos generados con la combinación de servicio, con viento a 70km/h

De acuerdo con lo proyectado se continuo con la revisión de los contantes y la capacidad de la viga a ellos, ante los cuales se realizó una comparación de la información en los planos de la estructura y los requerimientos mínimos de AASHTO, para esta verificación se realizó el

análisis cada 5 metros para así acoger secciones de diferentes secciones y los máximos proyectados en las mismas para finalmente llegar a los resultados de los cuadros 16, 17 y 18, los resultados completos se encuentran en el área de anexos.

Cuadro 16. Cortante Tramo 1			
Ubicación (m)	$\Phi \times V_n$	V aplicado	$V_u/\Phi V_n$
0.00	396,249.56	133,079.00	0.34
15.00	412,759.96	50,105.00	0.12
35.00	511,822.34	346,045.00	0.68
50.00	767,733.52	589,962.00	0.77
55.25	949,347.90	679,370.00	0.72

Cuadro 17. Cortante Tramo 2			
Ubicación (m)	$\Phi \times V_n$	V aplicado	$V_u/\Phi V_n$
56.25	949,347.90	679,370.00	0.72
75.00	733,903.39	363,645.00	0.50
95.00	526,714.08	61,184.00	0.12
115.00	474,916.75	219,681.00	0.46
135.00	682,106.06	507,662.00	0.74
157.25	949,347.90	858,117.00	0.90

Cuadro 18. Cortante Tramo 3			
Ubicación (m)	$\Phi \times V_n$	V aplicado	$V_u/\Phi V_n$
157.25	941,092.70	858,117.00	0.91
172.25	2,237,373.64	490,051.00	0.22
187.25	2,324,555.83	121,610.00	0.05

Resultados Sub estructura

La verificación de la subestructura se realizó de igual manera en los resultados brindados por el modelo. Las comprobaciones se iniciaron mediante la realización de los diagramas de interacción de las pilas.

La pila 1 posee una geometría transversal de forma circular uniforme, se decide que el diagrama este conformado por 5 puntos sobre las cargas combinadas y 15 bajo las mismas tal cual se observa en la gráfica 5.

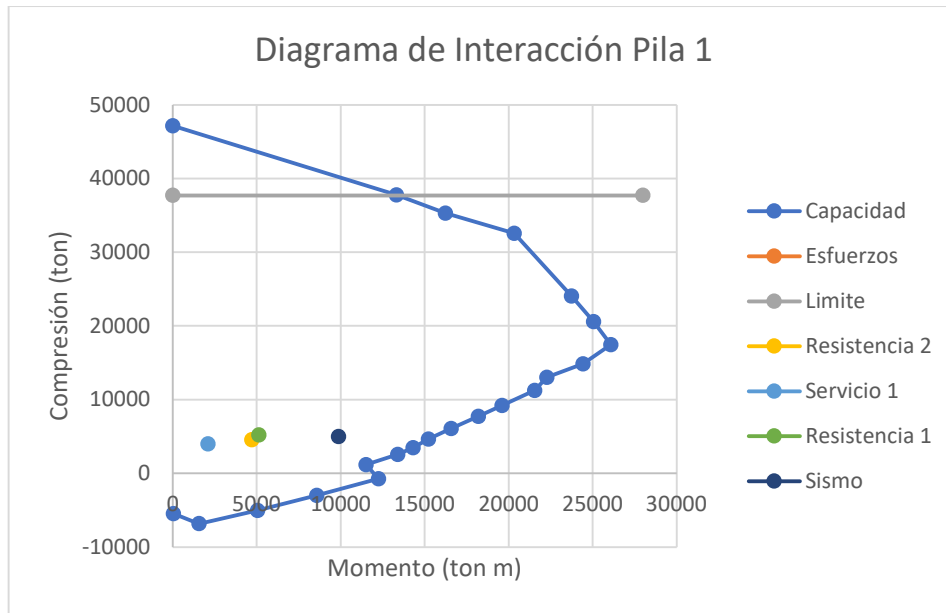

Grafica 6. Diagrama Interacción Pila 1

En el caso de la pila 2 ya que posee forma rectangular, necesita ser analizada en ambas direcciones para comprobar la menor capacidad

tal cual se presenta en las gráficas 6 y 7, en donde se comparan contra los esfuerzos de máximos en la pila.

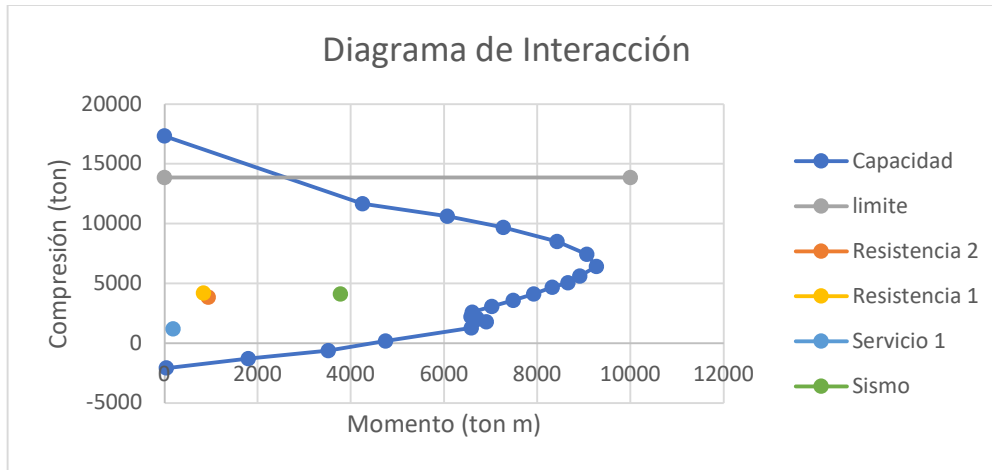

Grafica 7. Diagrama X de Pila 2

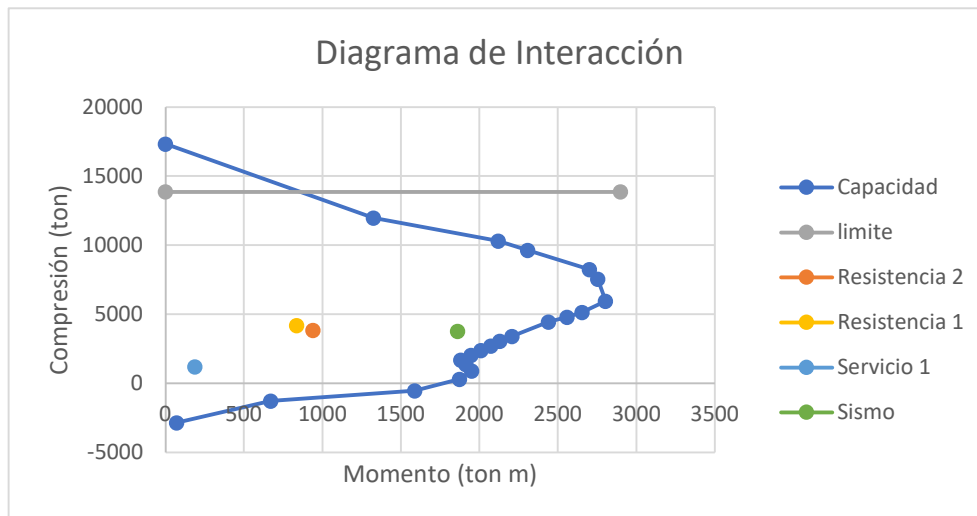

Grafica 8. Diagrama Y de Pila 2

Se realizó la comparación de los resultados de la capacidad de cortante de las pilas y el cortante último proyectado en el escenario del tránsito de la carga especial presentado en el cuadro 19.

Se realizó una revisión del bastión el cual posee función únicamente de soporte y no de contención el cual cuenta con secciones. En el caso de la viga cabezal del bastión la comprobación de flexión y cortante se realizó según el procedimiento de vigas rectangulares, también se hizo la revisión de las columnas en flexo-compresión y cortante,

resultados los cuales se presentan en el cuadro 20. Por su parte el cortante en la viga cabezal se muestra en el cuadro 21.

Cuadro 19. Cortante en las Pilas			
Pila	ΦV_n (ton)	V_u (ton)	$V_u/\Phi V_n$
1	1460	135.0	0.09
2 (x)	3016	130.0	0.043
2 (y)	2518	130	0.052

Cuadro 20. Esfuerzos de Flexión en Viga Cabezal

Elemento	$\Phi \times Mn$ (ton m)	Mu (ton m)	$Mu/\Phi \times Mn$
Viga Cabezal	38.79	6.6	0.17

Cuadro 21. Cortante en V Cabezal

Dato	Valor	Unidad
ΦVn	472.76	Ton
Vu	23.00	Ton
$Vu/\Phi Vn$	0.05	-

Análisis de Resultados

Con los resultados de la inspección visual realizada en el 2015 por el CIVCO se determinó que el daño mayor del puente se ha dado en los accesorios, los cuales no han tenido un mantenimiento adecuado a lo largo del tiempo, lo que ha generado que se presenten incluso partes faltantes de las barandas y malas reparaciones de la superficie de rodamiento.

Por su parte la superestructura es la sección del puente con una mejor condición junto con la subestructura, las cuales poseen algunas grietas principalmente en una dirección y de poco espesor, desde que el puente fue analizado en el año 2007, hasta las últimas evaluaciones en 2015 la eflorescencia se ha mantenido, pero la misma se encuentra en áreas definidas y no se ha expandido de forma importante, en el caso de la pila 1 poseen algunas grietas pequeñas y daños ligeros provocados por rocas que han bajado por el cauce del río y la pila 2 junto con el bastión poseen algunas grietas y eflorescencia, pero ningún daño importante.

En forma general el puente obtuvo una calificación satisfactoria en relación con los índices de medición de satisfactoria, pues la condición general es mayor que 2, esto a su vez es un reflejo de que la condición estructural se ha preservado en el tiempo, esto se ratificó con los estudios realizados en el 2007, en donde se indica que la resistencia promedio de las vigas cajón supera en 30kg/cm² a la resistencia del concreto proyectada, la cual inicialmente era de 350kg/cm².

Con la información del modelo se comparan las deflexiones proyectadas por este contra las existentes en la realidad, donde el puente posee una deformación real cerca a los 27cm.

Según lo proyectado en el modelo, la deformación original proyectada para el diseño de la estructura debió ser aproximadamente de 20cm sin una carga viva, la cual era ya muy alta, superando los 12.8cm recomendados por AASHTO.

Al aplicarle las cargas deben sumársele las deflexiones y como se observa en la gráfica 2 la deformación generada por las cargas tanto la de HS20-44+25% como la generada por la carga especial son de 1.6cm y 2.7cm extra respectivamente, tienen un efecto menor si se compara con las cargas naturales del puente.

Si se analizan los tramos como se observa en el cuadro 14 el tramo más largo es a su vez el que presenta deflexiones más altas y anormales con un 230% de lo recomendado, o de 23.9cm proyectados.

Estas deflexiones por sí solas no representan la posibilidad de una falla estructural o de servicio ante el paso excepcional de una sola carga, como fue consultado a la ingeniera Gianina Ortiz, este tipo de cargas y deflexiones pueden generar la aparición de más grietas en la estructura principal del puente, pero no representa una inhabilitación del puente por un uso extraordinario.

Una vez realizadas las deflexiones se prosigue con el análisis numérico del puente el cual se inició con la superestructura.

Para ello se realizó la verificación de los esfuerzos de flexión en la viga cajón, como se menciona anteriormente al realizar los cálculos los mismos evidencian zonas en las cuales la capacidad no cumpliría como se observa en el cuadro 15, por lo cual se decidió realizar una prueba extra, ya que el puente fue verificado en el 2007 como un puente con diseño y condición para un tránsito de cargas HS20-44 +25%, esta condición al ser comparada con la comprobación

con la combinación de verificación resistencia 2 y servicio 1 de AASHTO permite observar en las gráficas 3, 4 y 5 que si bien son muy similares las gráficas de resistencia la capacidad mínima a los esfuerzos de diseño permitidos son mayores a los que se expondrían ante el paso de la carga especial, y mucho mayores en el caso del análisis de servicio el cual contiene el análisis con cargas de viento.

Ya que los planos no necesariamente muestran el diseño real del puente y al realizar el cálculo mediante las cuantías de acero, se decidió no tomar en cuenta el cuadro 15 y apoyarse en las gráficas 3 y 4, las cuales muestran que el puente está capacitado para soportar los esfuerzos a flexión a los cuales serían expuestos, ya que son inferiores para las cargas que fue diseñado siendo los últimos el parámetro limitante.

Al continuar con la superestructura se llevó a cabo el análisis de la capacidad de cortante, cabe destacar que para esto se realizó la distancia de aros máxima permitida y el espesor de barra más pequeño que se menciona en planos, para lo cual como se observa en los cuadros 16, 17 y 18 las secciones en las cuales se realizarón los cálculos poseen una capacidad suficiente para soportar los cortantes últimos aun en las condiciones conservadoras planteadas para la evaluación.

La torsión no fue analizada en este caso ya que, al mantener la vía cerrada para poder transportar las cargas, la misma serían trasladada justo por el centro de la vía lo que ocasiona que los esfuerzos torsores sean bajos.

Al continuar con la evaluación lo siguiente fue la subestructura, se puede observar que la exigencia está en la pila en según la gráfica 6 la capacidad es mucho más amplia que los esfuerzos flexo-compresivos últimos en una condición con ausencia de sismo. Ya que no se analizó el sismo y siguiendo la recomendación de AASHTO (2020) el factor de reducción para esta prueba es de 0.65 en los puntos sobre la carga balanceada y factores entre los 0.65 y 0.9 según la deformación del último acero, lo cual permite obtener el valor más bajo proyectado para la capacidad, cabe recordar que los miembros a compresión conformados por

aros únicamente evalúan el 80% de su capacidad, lo que significa que la pila está diseñada con un amplio respaldo para estas condiciones de carga.

La evaluación del cortante en la pila 1 se realizó de igual forma según la cuantía mínima y la máxima separación permitida, los resultados se muestran en el cuadro 19, la capacidad supera ampliamente los esfuerzos últimos, esta revisión se efectuó únicamente en la parte superior pues se posee un cortante constante y además el área generalmente posee aros más distanciados y una fuerza compresiva menor, por lo tanto al descender en la columna la capacidad aumentaría.

En el caso de la pila 2 se utilizó el mismo procedimiento de obtención de resultados que en la pila 1, con la diferencia de que se realizaron comprobaciones en ambas direcciones tanto de flexocompresión como de cortante, con los resultados presentados en la gráfica 7 y 8, el caso del cortante se observa en el cuadro 19, donde la capacidad de la pila es muy amplia comparada con sus esfuerzos.

El bastión por su parte fue analizado tanto en la viga cabezal como en las columnas, la exigencia de las columnas ante esfuerzos de compresión son sumamente bajos al igual que los momentos sobre estas, lo cual sumado a que estos están en gran parte bajo la superficie genera un efecto estabilizador del elemento.

Además, se comprobó con el modelo que las columnas actúan principalmente a compresión, pero las mismas poseen una gran capacidad de flexocompresión lo cual puede corroborarse en el apéndice 6.

Por su parte la viga cabezal se revisa suponiendo que es una viga simplemente reforzada y con la cuantía mínima de acero, pues no existe un detalle exacto de la misma, como se expresa en el cuadro 20, la misma se comporta satisfactoriamente, ante lo cual, si la viga posee un refuerzo mayor diseñado según las indicaciones de AASHTO o ACI la viga tendrá una mayor capacidad, no siendo un factor limitante. En el caso del bastión existe un detalle que no fue posible analizar y este es el neopreno, ya que no

existe información de su tamaño, material o capacidad se toma como una limitante del análisis.

Una de las limitaciones para este análisis es la verificación de las fundaciones, producto de que no hay un registro de los suelos en esta ubicación, ante esto se toma como guía el registro realizado en 2007 en donde se menciona que se encuentra en suelos superficialmente duros, y siendo un puente de casi 8000 toneladas, diseñado para soportar el paso de cargas superiores a las 50 ton, una sobrecarga aproximada de 100 ton en el puente sería aproximadamente un 1.25%, en donde sino existen desplazamientos en las fundaciones de forma importante no es probable que se dé por esta carga.

Para finalizar el análisis debe considerarse que el estudio realizado se apegó a criterios conservadores como forma de compensación ante las limitaciones presentadas por la administración del puente, pero el mismo posee un diseño amplio y fuerte el cual ha mantenido una condición satisfactoria, en otras palabras, el puente no muestra señas de un decremento de su capacidad estructural.

Conclusiones

Según lo proyectado por el estudio JICA-MOPT el puente no necesitará intervenciones importantes en su estructura en condiciones normales de uso hasta el 2035.

Según el estudio JICA-MOPT el puente posee valores de deformaciones mayores a las recomendadas, las cuales según las revisiones del CIVCO no generaron daños importantes en la estructura, según el análisis realizado junto con las deformaciones proyectadas por el modelo para el uso especial, las mismas no representan una limitante para el uso del puente.

La superestructura diseñada con la metodología LRFD y los valores de sobre resistencia permite soportar esfuerzos mayores a los que generará a la carga a su paso, según la comparación de los esfuerzos previstos, en un diseño contra la comprobación.

Las pilas, evaluadas con refuerzos mínimos poseen una capacidad adecuada para soportar las condiciones en el paso de la carga.

El bastión tiene una capacidad suficiente para el paso de la carga especial.

El puente posee una capacidad para soportar la carga viva proyectada para el transporte de carga especial, la cual consta de 150 ton incluyendo el peso del camión y los equipos necesarios, con desplazamientos constantes inferiores a los 10km/h.

Recomendaciones

1. Revisión y levantamiento de los neoprenos ubicados en el primer bastión tanto antes como después del paso de la carga.
2. Se sugiere la adquisición y utilización del software CSi Bridge para las evaluaciones de puentes por parte del ICE, pues el programa ofrece herramientas valiosas que permiten generar verificaciones automáticas utilizando los códigos de diseño internacionales incluyendo los de AASHTO, los de Europa y Japón, en donde el puente únicamente se modela y el programa analiza y responde si los esfuerzos que se desean aplicar a la estructura cumplen con las limitaciones de diseño y las combinaciones seleccionadas. con lo cual el proceso de verificación se limitaría a inspecciones visuales previas al paso de cargas.
3. Generar un sistema de participación interinstitucional con el MOPT y las municipalidades en relación con las rutas utilizadas con el fin complementar mejor la base de datos SAEP para aprovechar los recursos aplicados.
4. Capacitar al personal en el uso del sistema SAEP con el fin de que el personal pueda obtener más información, sobre el estado de los puentes nacionales y cantonales.
5. Crear un sistema único de evaluación de puentes según las necesidades del Instituto Costarricense de Electricidad, el cual se base en un protocolo que permita facilitar el procedimiento a seguir, priorizando los elementos críticos, para el uso deseado.
6. Realizar las verificaciones visuales por medio de equipos de trabajo capacitados, en el área estructural y enfocados en los parámetros a evaluar.

Referencias

- Ingenieros y de arquitectos de Costa Rica.
- American Association of State Highway and Transportation Officials (AASHTO). (2020). **LRFD BRIDGE DESIGN SPECIFICATIONS**. 9na ed. Estados Unidos. Editorial American Association of State Highway and Transportation Officials.
- American Association of State Highway and Transportation Officials (AASHTO). (2018). **The Manual for Bridge Evaluation**. 3ra ed. Estados Unidos. Editorial American Association of State Highway and Transportation Officials.
- American Concrete Institute (ACI). (2019). **Building Code Requirements for Structural Concrete (ACI318-19)**. Estados Unidos. Editorial: American Concrete Institute.
- Centro de investigación de vivienda y construcción (CIVCO). (2015). Informe de Inventario e Inspección Visual de Daños puente sobre río Sucio. Propiedad del Consejo Nacional de Vialidad (CONAVI). **CIVCO**. Costa Rica
- Centro de investigación de vivienda y construcción (CIVCO). (2019). Informe de Inventario de puentes en rutas nacionales de Costa Rica. Propiedad del Consejo Nacional de Vialidad (CONAVI). **CIVCO**. Costa Rica.
- CFIA. (2013). Lineamientos para el diseño Sismorresistente de Puentes. Costa Rica. Editorial: Colegio Federado de
- Computer and Structures Inc. (2021). CSI BRIDGE Information General. **CSiEspaña**. www.csiespana.com/
- Federal Highway Administration (FHWA) & National Highway Institute (NHI). (2015). **Load and Resistance Factor Design for Highway Bridge Superstructures**. Estados Unidos. US Department of Transportation.
- Federal Highway Administration (FHWA) & National Highway Institute (NHI). (2015). **Bridge Inspector's Reference Manual**. 1 vol. Estados Unidos. US Department of Transportation.
- Federación de Enseñanza de Andalucía (Feandalucia). (2011). Tipos de Esfuerzos Físicos. **Temas para la educación**. Vol n°15 Julio 2011. Feandalucia. España
- Instituto de Ingeniería UNAM; Asociación Nacional de Industriales del Preesfuerzo y la Prefabricación AC. (2000). **Manual de diseño de estructuras prefabricadas y presforzadas**. ANIPPAC. México.
- Juan Manterola. (2016). **Los ingenieros han descubierto la creación del mundo moderno en formas. Circulo de Bellas Artes**. España.
- Laboratorio Nacional de Materiales y Modelos Estructurales (KANAMME). (2009). Evaluación de la vulnerabilidad ante amenazas naturales, Ruta Nacional 32, tramo San José- Río Sucio. **LAMNAMME**. Costa Rica
- Ministerio de Obras Públicas y Transportes (MOPT). (2007) **Manual de Inspección de Puentes**. San José, Costa Rica.
- Ministerio de Obras Públicas y Transportes (MOPT) & Agencia de Cooperación Internacional de Japón (JICA). (2007). **El estudio sobre el desarrollo de**

capacidad en la planificación de rehabilitación, mantenimiento y administración de puentes basado en 29 puentes de la red de carreteras nacionales en Costa Rica. Costa Rica. Editorial: Oriental Consultants Company Limited.

Ortiz G et al. (2021). Priorización de Intervenciones en Puentes Utilizando

Indicadores. **Tecnología en Marcha.** Vol 34-3 julio-septiembre 2021. Pag 134-142. CIVCO. Costa Rica.

Ortiz G. (2021). Inspecciones Visuales. Cartago. Comunicación Personal.

Vidaud I. (2009). Concreto Presforzado: Una técnica con Historia. **Construcción y Tecnología en Concreto.** Instituto Mexicano del Cemento y Concreto. México.

Anexos

Anexo 1... Planos de la estructura

Anexo 2... Equipo de transporte de Carga

Anexo 1

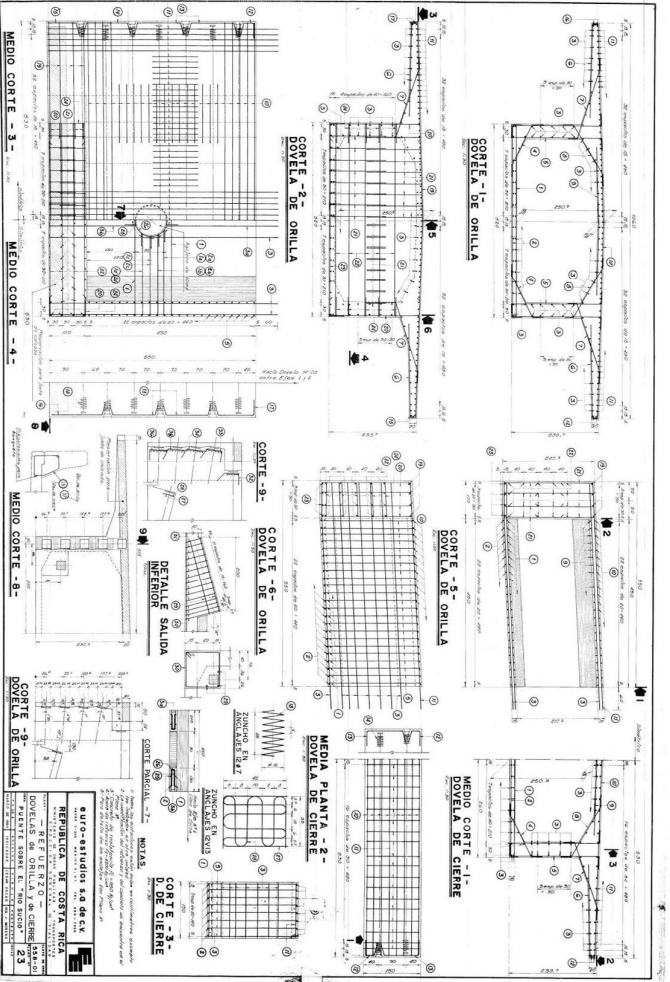
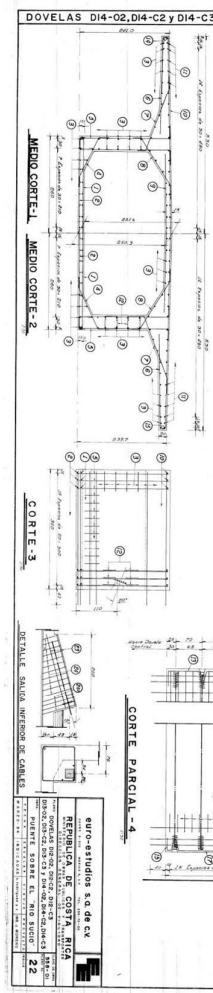
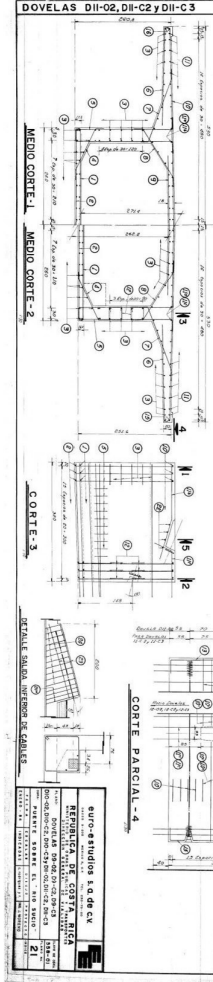
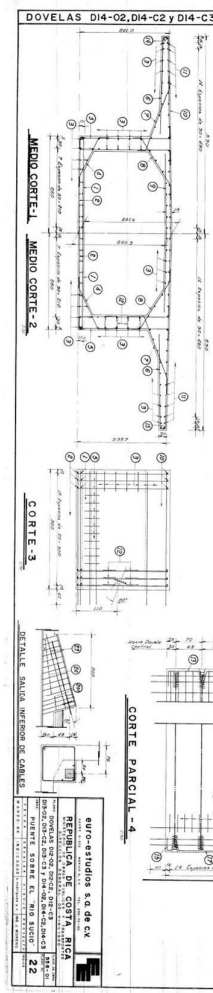
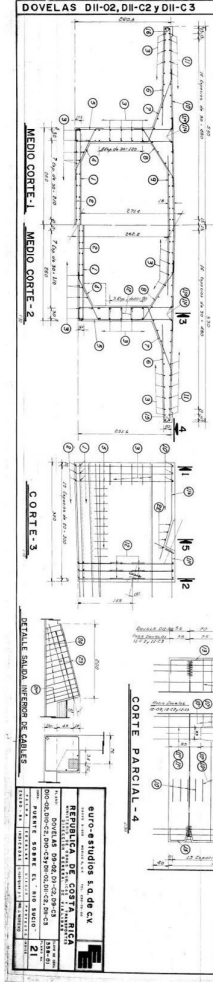
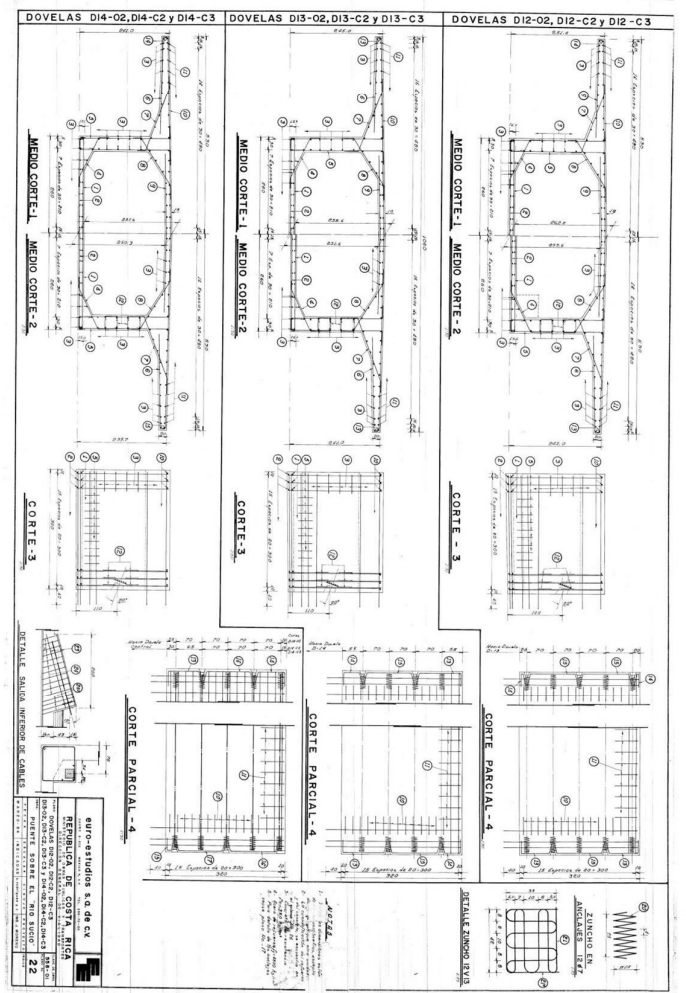
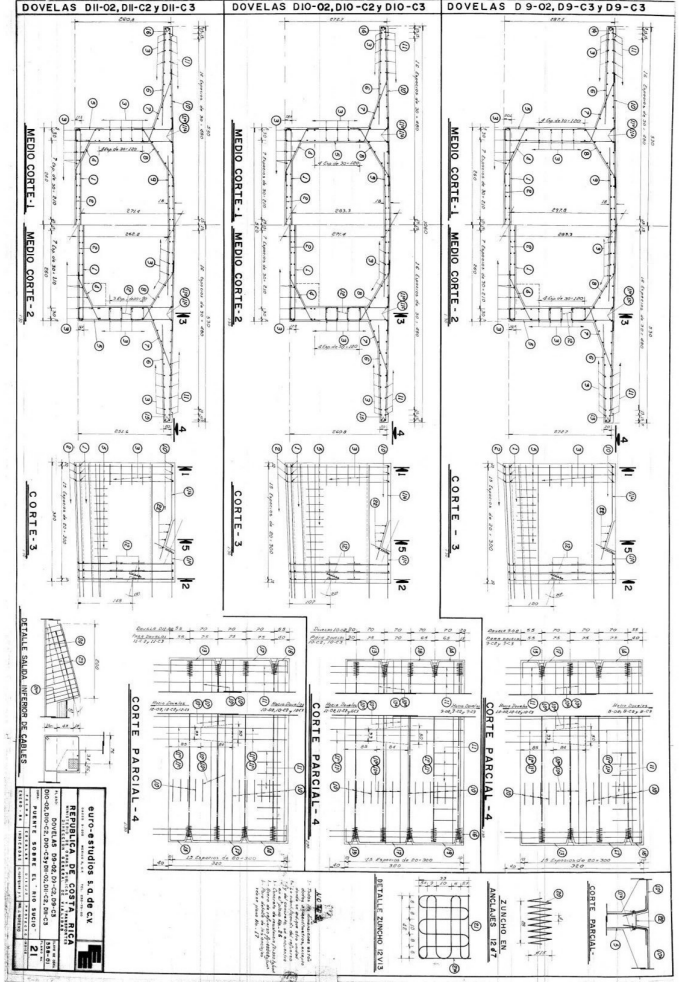

LISTA DE VARILLAS		LISTA DE VARILLAS		LISTA DE VARILLAS		LISTA DE VARILLAS	
DOVELAS TIPO D1		DOVELAS TIPO D2		DOVELAS TIPO D3		DOVELAS TIPO D4	
VARILLA	QUANTIDAD	VARILLA	QUANTIDAD	VARILLA	QUANTIDAD	VARILLA	QUANTIDAD
1	1	1	1	1	1	1	1
2	1	2	1	2	1	2	1
3	1	3	1	3	1	3	1
4	1	4	1	4	1	4	1
5	1	5	1	5	1	5	1
6	1	6	1	6	1	6	1
7	1	7	1	7	1	7	1
8	1	8	1	8	1	8	1
9	1	9	1	9	1	9	1
10	1	10	1	10	1	10	1
11	1	11	1	11	1	11	1
12	1	12	1	12	1	12	1
13	1	13	1	13	1	13	1
14	1	14	1	14	1	14	1
15	1	15	1	15	1	15	1
16	1	16	1	16	1	16	1
17	1	17	1	17	1	17	1
18	1	18	1	18	1	18	1
19	1	19	1	19	1	19	1
20	1	20	1	20	1	20	1
21	1	21	1	21	1	21	1
22	1	22	1	22	1	22	1
23	1	23	1	23	1	23	1
24	1	24	1	24	1	24	1
25	1	25	1	25	1	25	1
26	1	26	1	26	1	26	1
27	1	27	1	27	1	27	1
28	1	28	1	28	1	28	1
29	1	29	1	29	1	29	1
30	1	30	1	30	1	30	1
31	1	31	1	31	1	31	1
32	1	32	1	32	1	32	1
33	1	33	1	33	1	33	1
34	1	34	1	34	1	34	1
35	1	35	1	35	1	35	1
36	1	36	1	36	1	36	1
37	1	37	1	37	1	37	1
38	1	38	1	38	1	38	1
39	1	39	1	39	1	39	1
40	1	40	1	40	1	40	1
41	1	41	1	41	1	41	1
42	1	42	1	42	1	42	1
43	1	43	1	43	1	43	1
44	1	44	1	44	1	44	1
45	1	45	1	45	1	45	1
46	1	46	1	46	1	46	1
47	1	47	1	47	1	47	1
48	1	48	1	48	1	48	1
49	1	49	1	49	1	49	1
50	1	50	1	50	1	50	1
51	1	51	1	51	1	51	1
52	1	52	1	52	1	52	1
53	1	53	1	53	1	53	1
54	1	54	1	54	1	54	1
55	1	55	1	55	1	55	1
56	1	56	1	56	1	56	1
57	1	57	1	57	1	57	1
58	1	58	1	58	1	58	1
59	1	59	1	59	1	59	1
60	1	60	1	60	1	60	1
61	1	61	1	61	1	61	1
62	1	62	1	62	1	62	1
63	1	63	1	63	1	63	1
64	1	64	1	64	1	64	1
65	1	65	1	65	1	65	1
66	1	66	1	66	1	66	1
67	1	67	1	67	1	67	1
68	1	68	1	68	1	68	1
69	1	69	1	69	1	69	1
70	1	70	1	70	1	70	1
71	1	71	1	71	1	71	1
72	1	72	1	72	1	72	1
73	1	73	1	73	1	73	1
74	1	74	1	74	1	74	1
75	1	75	1	75	1	75	1
76	1	76	1	76	1	76	1
77	1	77	1	77	1	77	1
78	1	78	1	78	1	78	1
79	1	79	1	79	1	79	1
80	1	80	1	80	1	80	1
81	1	81	1	81	1	81	1
82	1	82	1	82	1	82	1
83	1	83	1	83	1	83	1
84	1	84	1	84	1	84	1
85	1	85	1	85	1	85	1
86	1	86	1	86	1	86	1
87	1	87	1	87	1	87	1
88	1	88	1	88	1	88	1
89	1	89	1	89	1	89	1
90	1	90	1	90	1	90	1
91	1	91	1	91	1	91	1
92	1	92	1	92	1	92	1
93	1	93	1	93	1	93	1
94	1	94	1	94	1	94	1
95	1	95	1	95	1	95	1
96	1	96	1	96	1	96	1
97	1	97	1	97	1	97	1
98	1	98	1	98	1	98	1
99	1	99	1	99	1	99	1
100	1	100	1	100	1	100	1

GOBIERNO DE COSTA RICA

COMISIÓN NACIONAL DE PUENTES

DIRECCION DE PUENTES

DISEÑO

APROBADO

REVISADO

ESCALA

FECHA

PLAN GENERAL

PUENTE SOBRE RIO SUCIO E.L. 32

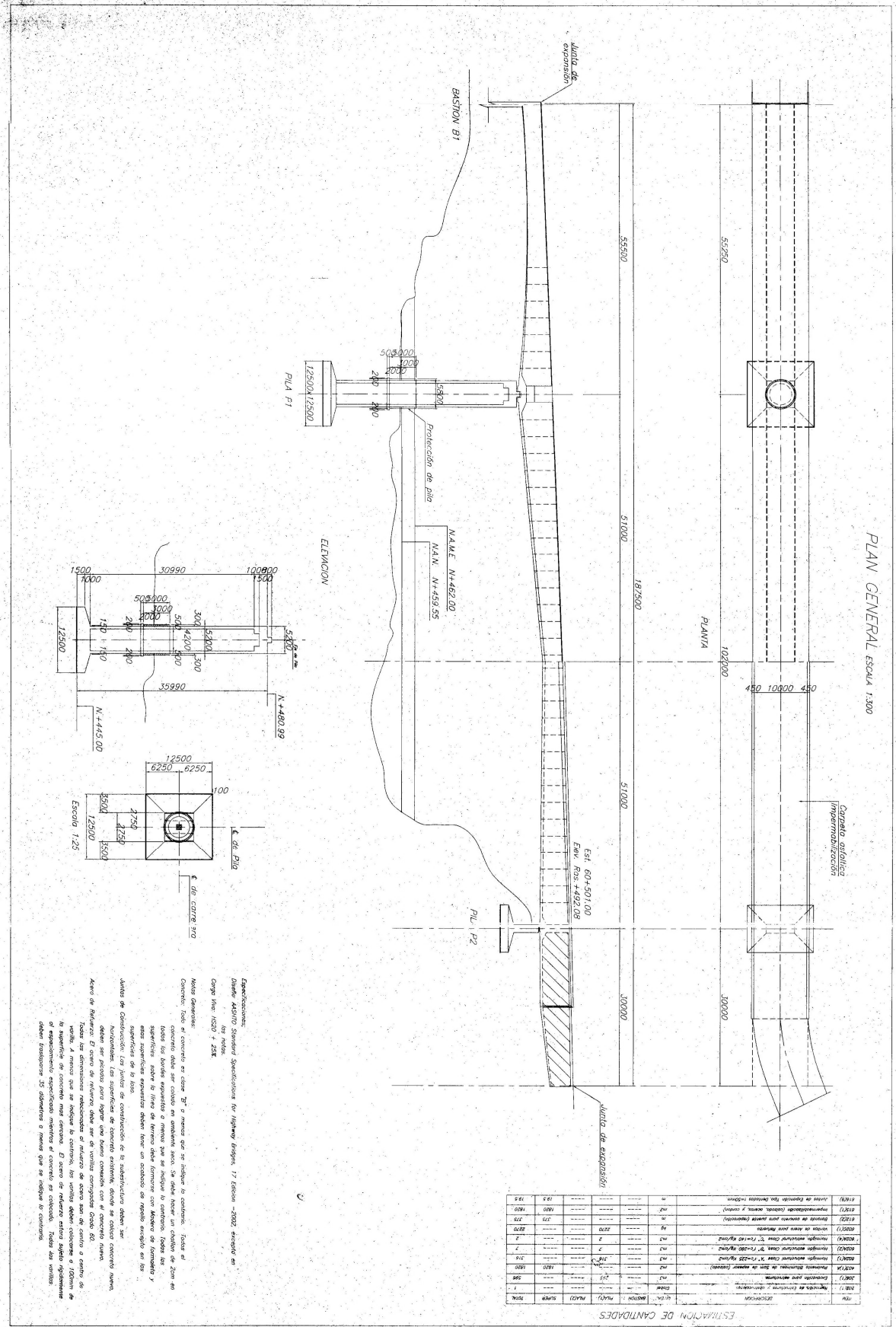

PLAN GENERAL ESCALA 1:300

ESTIMACION DE CANTIDADES

ITEM	DESCRIPCION	UNIDAD	CANTIDAD	VALOR	TOTAL
1.001	Gravilla para macadam	m ³	1000	1000	1000
1.002	Gravilla para base	m ³	1000	1000	1000
1.003	Gravilla para sub-base	m ³	1000	1000	1000
1.004	Gravilla para drenaje	m ³	1000	1000	1000
1.005	Gravilla para juntas	m ³	1000	1000	1000
1.006	Gravilla para juntas	m ³	1000	1000	1000
1.007	Gravilla para juntas	m ³	1000	1000	1000
1.008	Gravilla para juntas	m ³	1000	1000	1000
1.009	Gravilla para juntas	m ³	1000	1000	1000
1.010	Gravilla para juntas	m ³	1000	1000	1000
1.011	Gravilla para juntas	m ³	1000	1000	1000
1.012	Gravilla para juntas	m ³	1000	1000	1000
1.013	Gravilla para juntas	m ³	1000	1000	1000
1.014	Gravilla para juntas	m ³	1000	1000	1000
1.015	Gravilla para juntas	m ³	1000	1000	1000
1.016	Gravilla para juntas	m ³	1000	1000	1000
1.017	Gravilla para juntas	m ³	1000	1000	1000
1.018	Gravilla para juntas	m ³	1000	1000	1000
1.019	Gravilla para juntas	m ³	1000	1000	1000
1.020	Gravilla para juntas	m ³	1000	1000	1000
1.021	Gravilla para juntas	m ³	1000	1000	1000
1.022	Gravilla para juntas	m ³	1000	1000	1000
1.023	Gravilla para juntas	m ³	1000	1000	1000
1.024	Gravilla para juntas	m ³	1000	1000	1000
1.025	Gravilla para juntas	m ³	1000	1000	1000
1.026	Gravilla para juntas	m ³	1000	1000	1000
1.027	Gravilla para juntas	m ³	1000	1000	1000
1.028	Gravilla para juntas	m ³	1000	1000	1000
1.029	Gravilla para juntas	m ³	1000	1000	1000
1.030	Gravilla para juntas	m ³	1000	1000	1000
1.031	Gravilla para juntas	m ³	1000	1000	1000
1.032	Gravilla para juntas	m ³	1000	1000	1000
1.033	Gravilla para juntas	m ³	1000	1000	1000
1.034	Gravilla para juntas	m ³	1000	1000	1000
1.035	Gravilla para juntas	m ³	1000	1000	1000
1.036	Gravilla para juntas	m ³	1000	1000	1000
1.037	Gravilla para juntas	m ³	1000	1000	1000
1.038	Gravilla para juntas	m ³	1000	1000	1000
1.039	Gravilla para juntas	m ³	1000	1000	1000
1.040	Gravilla para juntas	m ³	1000	1000	1000
1.041	Gravilla para juntas	m ³	1000	1000	1000
1.042	Gravilla para juntas	m ³	1000	1000	1000
1.043	Gravilla para juntas	m ³	1000	1000	1000
1.044	Gravilla para juntas	m ³	1000	1000	1000
1.045	Gravilla para juntas	m ³	1000	1000	1000
1.046	Gravilla para juntas	m ³	1000	1000	1000
1.047	Gravilla para juntas	m ³	1000	1000	1000
1.048	Gravilla para juntas	m ³	1000	1000	1000
1.049	Gravilla para juntas	m ³	1000	1000	1000
1.050	Gravilla para juntas	m ³	1000	1000	1000
1.051	Gravilla para juntas	m ³	1000	1000	1000
1.052	Gravilla para juntas	m ³	1000	1000	1000
1.053	Gravilla para juntas	m ³	1000	1000	1000
1.054	Gravilla para juntas	m ³	1000	1000	1000
1.055	Gravilla para juntas	m ³	1000	1000	1000
1.056	Gravilla para juntas	m ³	1000	1000	1000
1.057	Gravilla para juntas	m ³	1000	1000	1000
1.058	Gravilla para juntas	m ³	1000	1000	1000
1.059	Gravilla para juntas	m ³	1000	1000	1000
1.060	Gravilla para juntas	m ³	1000	1000	1000
1.061	Gravilla para juntas	m ³	1000	1000	1000
1.062	Gravilla para juntas	m ³	1000	1000	1000
1.063	Gravilla para juntas	m ³	1000	1000	1000
1.064	Gravilla para juntas	m ³	1000	1000	1000
1.065	Gravilla para juntas	m ³	1000	1000	1000
1.066	Gravilla para juntas	m ³	1000	1000	1000
1.067	Gravilla para juntas	m ³	1000	1000	1000
1.068	Gravilla para juntas	m ³	1000	1000	1000
1.069	Gravilla para juntas	m ³	1000	1000	1000
1.070	Gravilla para juntas	m ³	1000	1000	1000
1.071	Gravilla para juntas	m ³	1000	1000	1000
1.072	Gravilla para juntas	m ³	1000	1000	1000
1.073	Gravilla para juntas	m ³	1000	1000	1000
1.074	Gravilla para juntas	m ³	1000	1000	1000
1.075	Gravilla para juntas	m ³	1000	1000	1000
1.076	Gravilla para juntas	m ³	1000	1000	1000
1.077	Gravilla para juntas	m ³	1000	1000	1000
1.078	Gravilla para juntas	m ³	1000	1000	1000
1.079	Gravilla para juntas	m ³	1000	1000	1000
1.080	Gravilla para juntas	m ³	1000	1000	1000
1.081	Gravilla para juntas	m ³	1000	1000	1000
1.082	Gravilla para juntas	m ³	1000	1000	1000
1.083	Gravilla para juntas	m ³	1000	1000	1000
1.084	Gravilla para juntas	m ³	1000	1000	1000
1.085	Gravilla para juntas	m ³	1000	1000	1000
1.086	Gravilla para juntas	m ³	1000	1000	1000
1.087	Gravilla para juntas	m ³	1000	1000	1000
1.088	Gravilla para juntas	m ³	1000	1000	1000
1.089	Gravilla para juntas	m ³	1000	1000	1000
1.090	Gravilla para juntas	m ³	1000	1000	1000
1.091	Gravilla para juntas	m ³	1000	1000	1000
1.092	Gravilla para juntas	m ³	1000	1000	1000
1.093	Gravilla para juntas	m ³	1000	1000	1000
1.094	Gravilla para juntas	m ³	1000	1000	1000
1.095	Gravilla para juntas	m ³	1000	1000	1000
1.096	Gravilla para juntas	m ³	1000	1000	1000
1.097	Gravilla para juntas	m ³	1000	1000	1000
1.098	Gravilla para juntas	m ³	1000	1000	1000
1.099	Gravilla para juntas	m ³	1000	1000	1000
1.100	Gravilla para juntas	m ³	1000	1000	1000

Notas: Todo el concreto en obra "B" o menor que se indique en columna. Todas las superficies expuestas deben tener un acabado de reboso simple en (B).

Notas de Construcción: Las juntas de construcción de la subestructura deben ser de tipo "B" y de concreto mas fuerte que el concreto de la estructura. El concreto de referencia debe ser de unida con gradiente 60.

Nota de Referencia: El centro de referencia debe ser de unida con gradiente 60.

Todas las dimensiones reducidas al final de cada una de ellas a un centro de unida. A menos que se indique lo contrario, las unidas deben colocarse a 100mm de las superficies de concreto mas cercano. El centro de referencia debe ser el centro de gravedad de las superficies de concreto. Todas las unidas deben ser de tipo "B" y de concreto mas fuerte que el concreto de la estructura. Se debe tener un acabado de reboso simple en (B).

PLAN GENERAL
PUENTE SOBRE RIO SUCIO E.L. 32
PROYECTO: RECONSTRUCCION DEL PUENTE

GOBIERNO DE COSTA RICA
COMISIÓN NACIONAL DE PUENTES
DIRECCION DE PUENTES
DISEÑO
APROBADO
REVISADO
ESCALA
FECHA
PLAN GENERAL
PUENTE SOBRE RIO SUCIO E.L. 32
PROYECTO: RECONSTRUCCION DEL PUENTE

PROTECCION DE PILA
PILA P1(1)

ESCALA 1:100

SECCION A-A

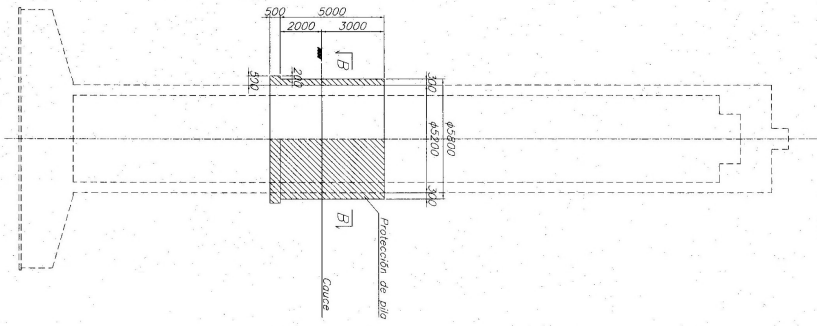

SECCION B-B

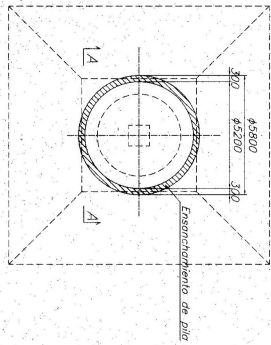

NOTAS:

Concreto: El concreto que se utiliza para la protección, debajo de la base debe ser Clase "C". El resto del concreto debe ser Clase "B".
Anchajes: Los anclajes de enclaje deben ser perforados con la profundidad y diámetro como lo muestra la tabla de acuerdo al diámetro de la barra de enclaje.

GOBIERNO DE COSTA RICA		DIRECCION DE PUENTES		DISEÑO		DIBUJO		AUTORIZADO		ESCALA		DISEÑO No. 1002	
COOPERACION JICA - MOP		DEPARTAMENTO DE PUENTES		ING. CARLOS		ING. CARLOS		ING. CARLOS		1:100		FOLIO 2 DE 3	
PROTECCION DE PILA PUENTE SOBRE RIO SUCQUI PROYECTO RECONSTRUCCION ALCANTARA													

Gobierno de Costa Rica
 COOPERACION JICA - MOP

DIRECCION DE PUENTES
 DEPARTAMENTO TECNICO DE PUENTES

DISEÑO: JUAN RAMIRO
 M.E. S.M.

REVISOR: JUAN RAMIRO
 M.E. S.M.

APROBADO: JUAN RAMIRO
 M.E. S.M.

ESCALA: Natural

HOJA No. 8 2003

PROTECCION DE PILA
 PUENTE SOBRE RIO SOCIO
 PROYECTO RECONSTRUCCION JICA/MOP

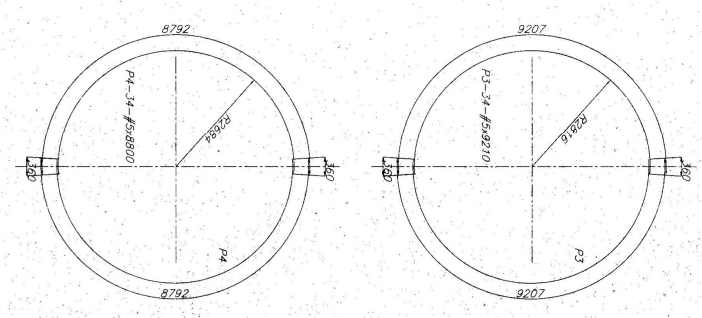
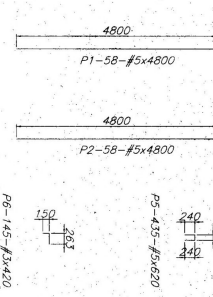
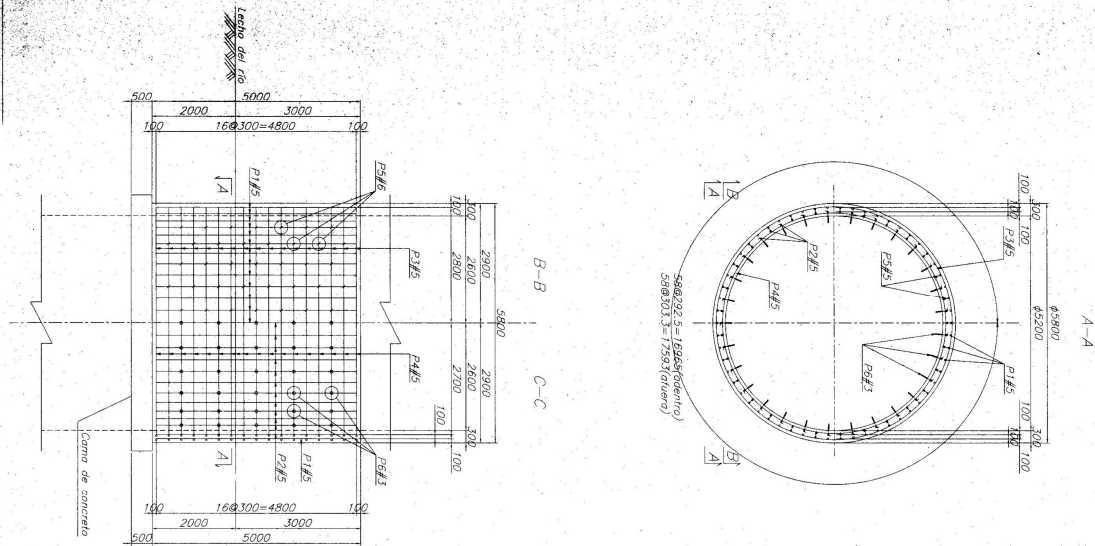

PROTECCION DE PILA ESCALA 1:50
 PILA P1(2)

ACERO DE REFUERZO

MARKA	#	LONGITUD (CM)	CMPT. (KGS)	MARKA	#	LONGITUD (CM)	CMPT. (KGS)
F1	F5	4800	58	F5	45	420	145
F2	F5	4800	58	F5	45	420	145
F3	F5	8210	34	F5	45	420	145
F4	F5	8800	34	F5	45	420	145
F5	F5	620	435	F5	45	420	145
F6	F3	420	145	F3	145	0.255	2288 kg
		TOTAL				2288 kg	

NOTAS:
 Concreto: El concreto que se utilizara para la proteccion debeja de la zona adha ser Clase "C". El resto del concreto debe ser Clase "B".
 Anclajes: Los agujeros de anclaje deben ser perforados con la profundidad y diametro como lo muestra la tabla de acuerdo al diametro de la bora de anclaje.

DETALLE DE ANCLAJE

MARKA	#	LONGITUD ANCLAJE (MM)	LONGITUD ANCLAJE (MM)	MARKA	#	LONGITUD ANCLAJE (MM)
1	5	150	150	2	5	150
2	5	200	200	3	5	200
3	5	250	250	4	5	250
4	5	300	300	5	5	300
5	5	350	350	6	5	350
6	5	400	400	7	5	400
7	5	450	450	8	5	450
8	5	500	500	9	5	500
9	5	550	550	10	5	550
10	5	600	600	11	5	600

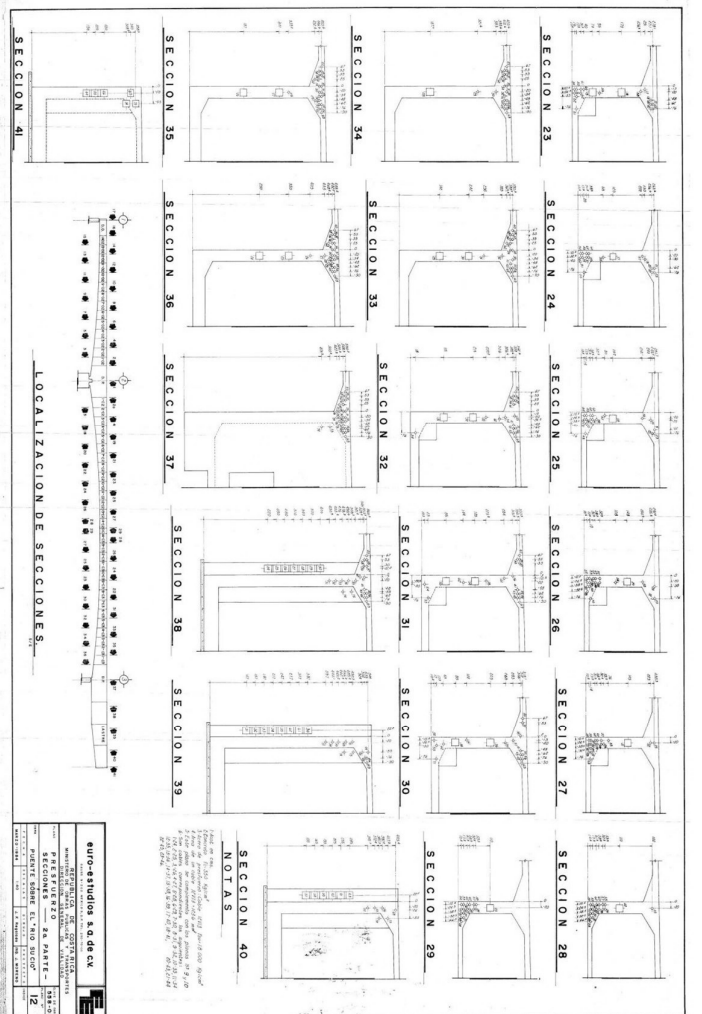
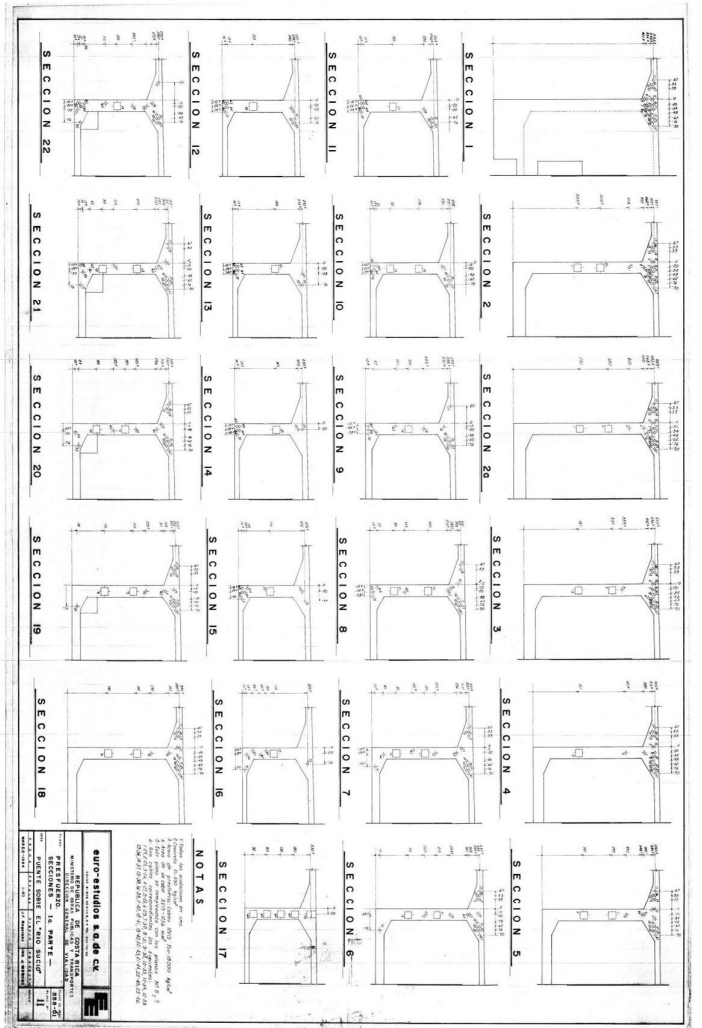
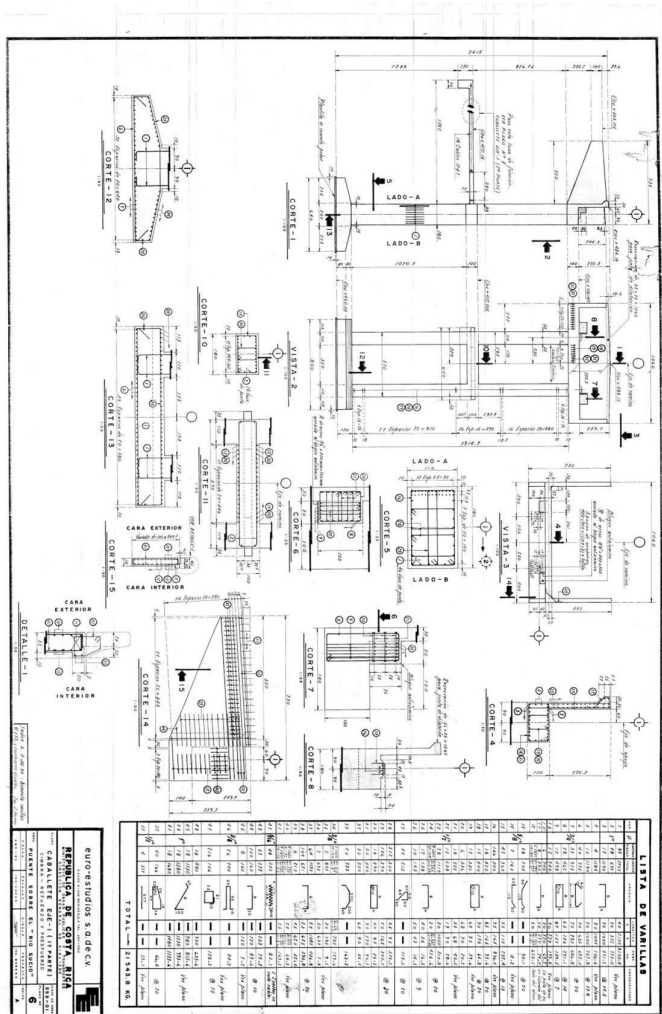
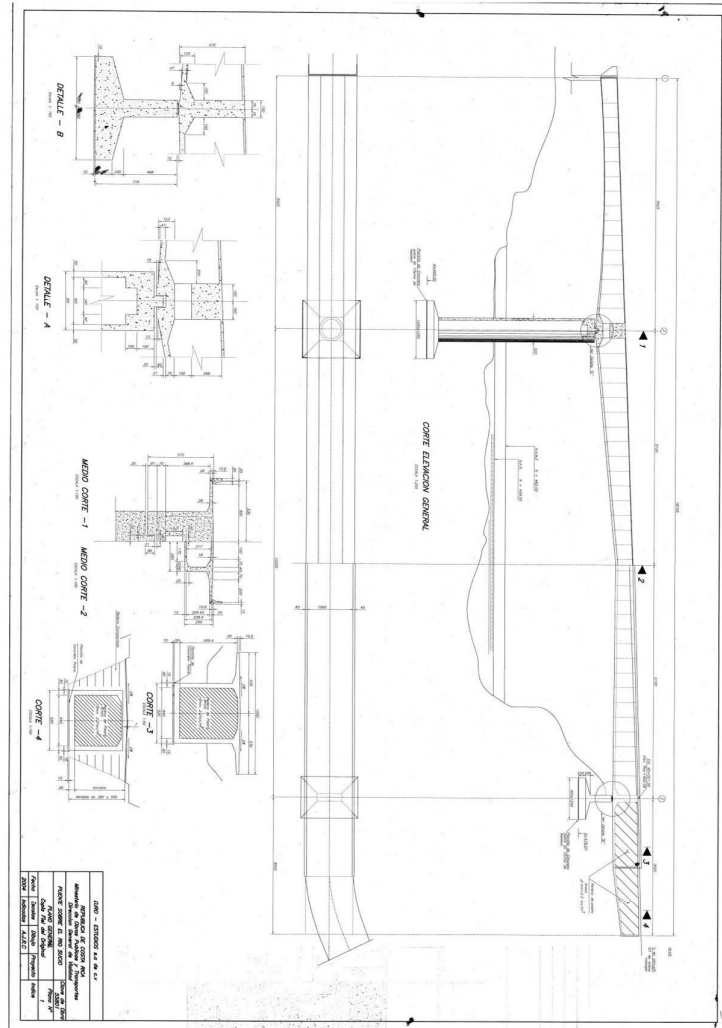

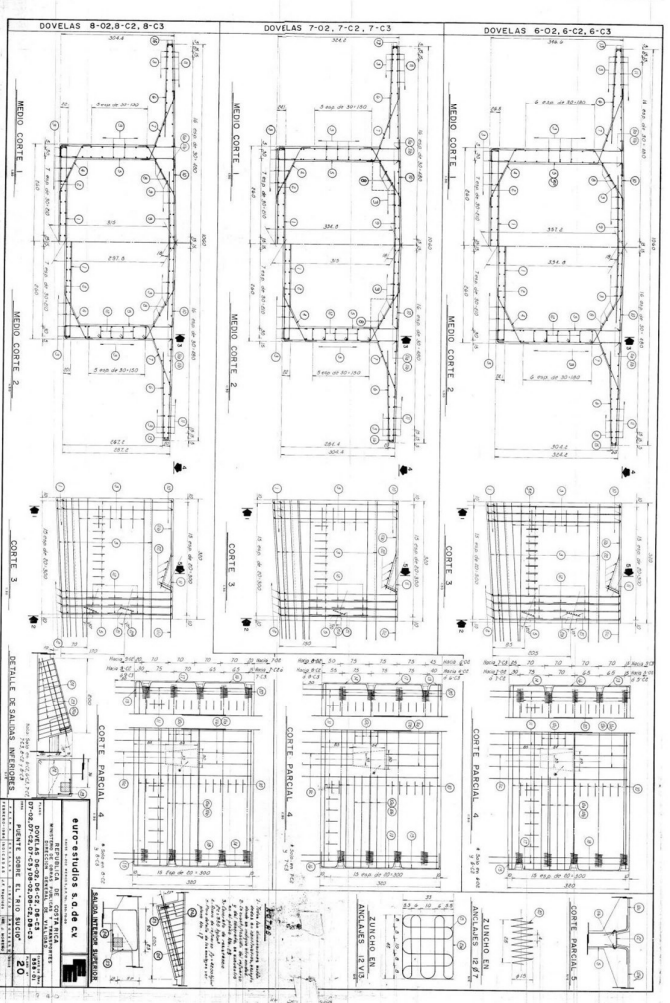
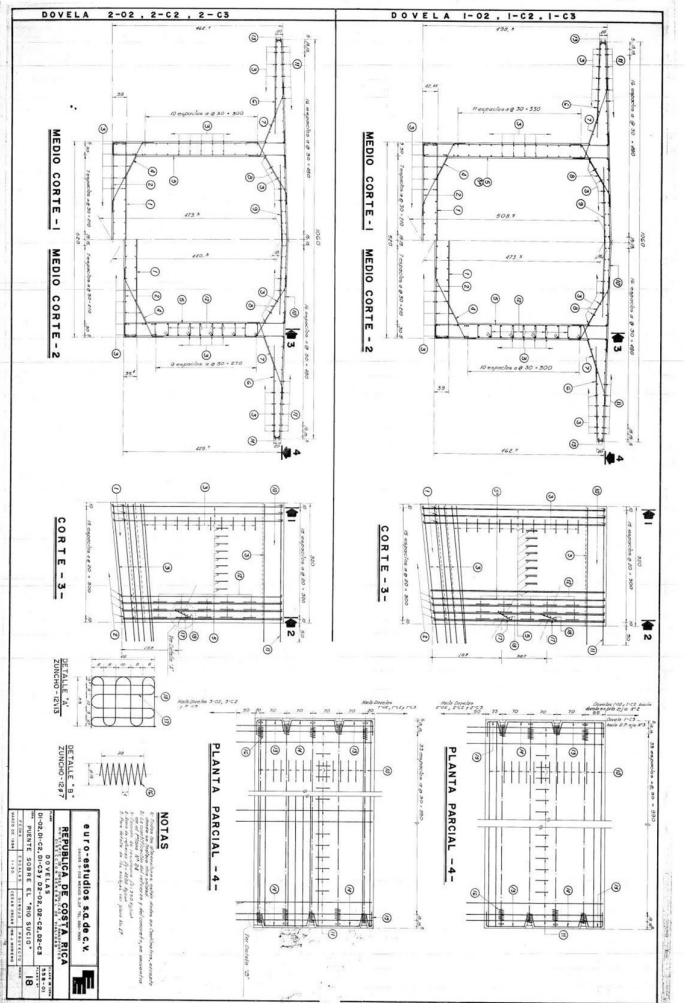
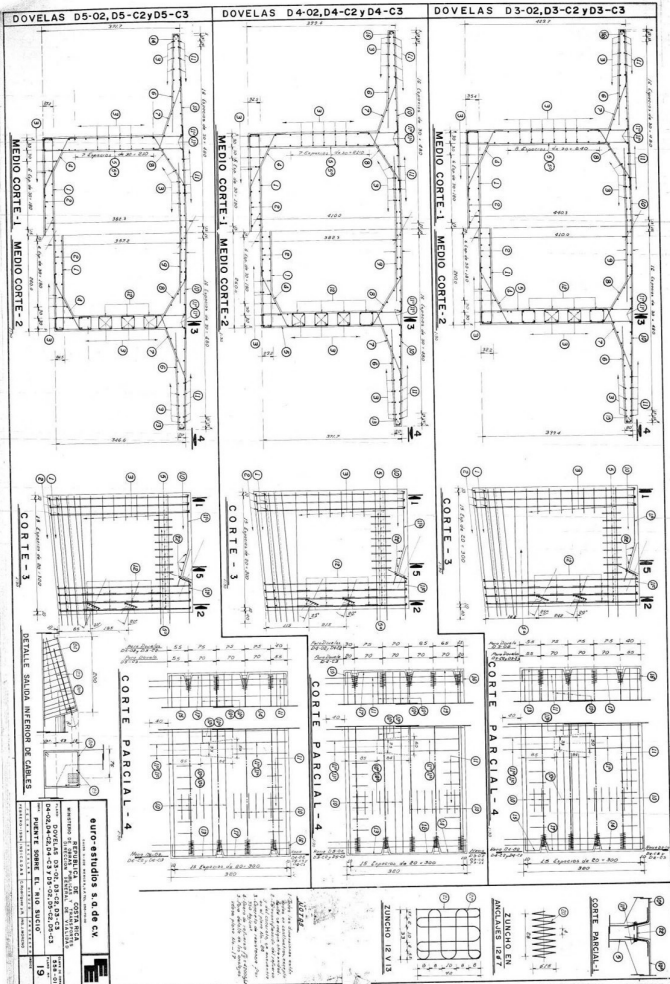
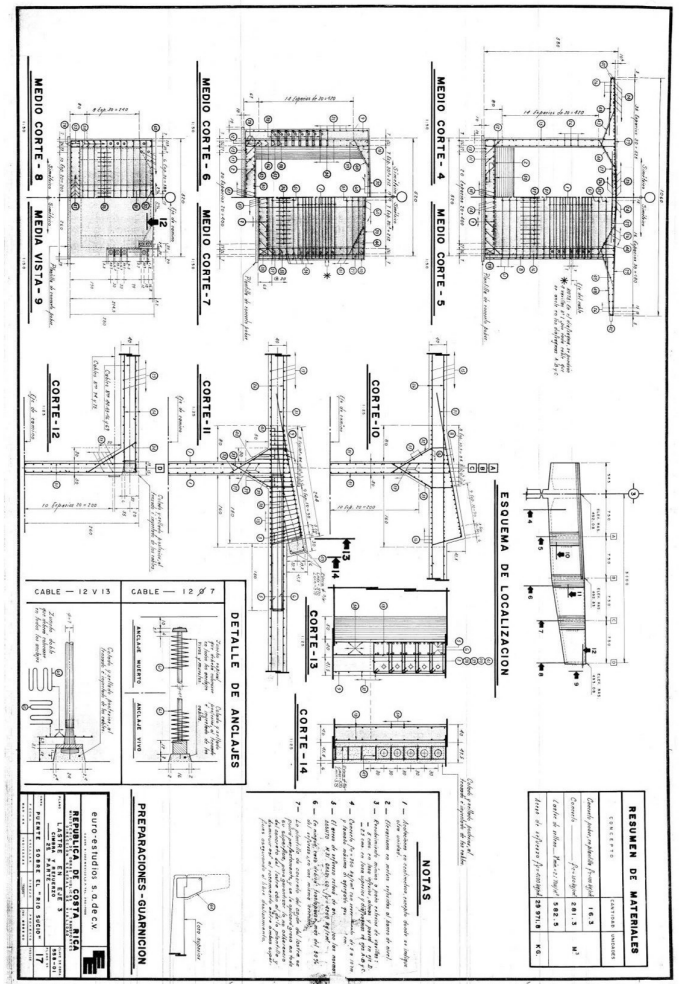

LISTA DE VARILLAS		
DOVELAS TIPO D-3		
1	10	10
2	10	10
3	10	10
4	10	10
5	10	10
6	10	10
7	10	10
8	10	10
9	10	10
10	10	10

LISTA DE VARILLAS		
DOVELAS TIPO D-4		
1	10	10
2	10	10
3	10	10
4	10	10
5	10	10
6	10	10
7	10	10
8	10	10
9	10	10
10	10	10

LISTA DE VARILLAS		
DOVELAS TIPO D-5		
1	10	10
2	10	10
3	10	10
4	10	10
5	10	10
6	10	10
7	10	10
8	10	10
9	10	10
10	10	10

LISTA DE VARILLAS		
DOVELAS TIPO D-6		
1	10	10
2	10	10
3	10	10
4	10	10
5	10	10
6	10	10
7	10	10
8	10	10
9	10	10
10	10	10

LISTA DE VARILLAS		
DOVELAS TIPO D-7		
1	10	10
2	10	10
3	10	10
4	10	10
5	10	10
6	10	10
7	10	10
8	10	10
9	10	10
10	10	10

LISTA DE VARILLAS		
DOVELAS TIPO D-8		
1	10	10
2	10	10
3	10	10
4	10	10
5	10	10
6	10	10
7	10	10
8	10	10
9	10	10
10	10	10

LISTA DE VARILLAS		
DOVELAS TIPO D-9		
1	10	10
2	10	10
3	10	10
4	10	10
5	10	10
6	10	10
7	10	10
8	10	10
9	10	10
10	10	10

LISTA DE VARILLAS		
DOVELAS TIPO D-10		
1	10	10
2	10	10
3	10	10
4	10	10
5	10	10
6	10	10
7	10	10
8	10	10
9	10	10
10	10	10

LISTA DE VARILLAS		
DOVELAS TIPO D-11		
1	10	10
2	10	10
3	10	10
4	10	10
5	10	10
6	10	10
7	10	10
8	10	10
9	10	10
10	10	10

LISTA DE VARILLAS		
DOVELAS TIPO D-12		
1	10	10
2	10	10
3	10	10
4	10	10
5	10	10
6	10	10
7	10	10
8	10	10
9	10	10
10	10	10

LISTA DE VARILLAS		
DOVELAS TIPO D-13		
1	10	10
2	10	10
3	10	10
4	10	10
5	10	10
6	10	10
7	10	10
8	10	10
9	10	10
10	10	10

LISTA DE VARILLAS		
DOVELAS TIPO D-14		
1	10	10
2	10	10
3	10	10
4	10	10
5	10	10
6	10	10
7	10	10
8	10	10
9	10	10
10	10	10

LISTA DE VARILLAS		
DOVELAS TIPO D-15		
1	10	10
2	10	10
3	10	10
4	10	10
5	10	10
6	10	10
7	10	10
8	10	10
9	10	10
10	10	10

LISTA DE VARILLAS		
DOVELAS TIPO D-16		
1	10	10
2	10	10
3	10	10
4	10	10
5	10	10
6	10	10
7	10	10
8	10	10
9	10	10
10	10	10

LISTA DE VARILLAS		
DOVELAS TIPO D-17		
1	10	10
2	10	10
3	10	10
4	10	10
5	10	10
6	10	10
7	10	10
8	10	10
9	10	10
10	10	10

LISTA DE VARILLAS		
DOVELAS TIPO D-18		
1	10	10
2	10	10
3	10	10
4	10	10
5	10	10
6	10	10
7	10	10
8	10	10
9	10	10
10	10	10

LISTA DE VARILLAS		
DOVELAS TIPO D-19		
1	10	10
2	10	10
3	10	10
4	10	10
5	10	10
6	10	10
7	10	10
8	10	10
9	10	10
10	10	10

LISTA DE VARILLAS		
DOVELAS TIPO D-20		
1	10	10
2	10	10
3	10	10
4	10	10
5	10	10
6	10	10
7	10	10
8	10	10
9	10	10
10	10	10

LISTA DE VARILLAS		
DOVELAS TIPO D-21		
1	10	10
2	10	10
3	10	10
4	10	10
5	10	10
6	10	10
7	10	10
8	10	10
9	10	10
10	10	10

LISTA DE VARILLAS		
DOVELAS TIPO D-22		
1	10	10
2	10	10
3	10	10
4	10	10
5	10	10
6	10	10
7	10	10
8	10	10
9	10	10
10	10	10

LISTA DE VARILLAS		
DOVELAS TIPO D-23		
1	10	10
2	10	10
3	10	10
4	10	10
5	10	10
6	10	10
7	10	10
8	10	10
9	10	10
10	10	10

LISTA DE VARILLAS		
DOVELAS TIPO D-24		
1	10	10
2	10	10
3	10	10
4	10	10
5	10	10
6	10	10
7	10	10
8	10	10
9	10	10
10	10	10

LISTA DE VARILLAS		
DOVELAS TIPO D-25		
1	10	10
2	10	10
3	10	10
4	10	10
5	10	10
6	10	10
7	10	10
8	10	10
9	10	10
10	10	10

LISTA DE VARILLAS		
DOVELAS TIPO D-26		
1	10	10
2	10	10
3	10	10
4	10	10
5	10	10
6	10	10
7	10	10
8	10	10
9	10	10
10	10	10

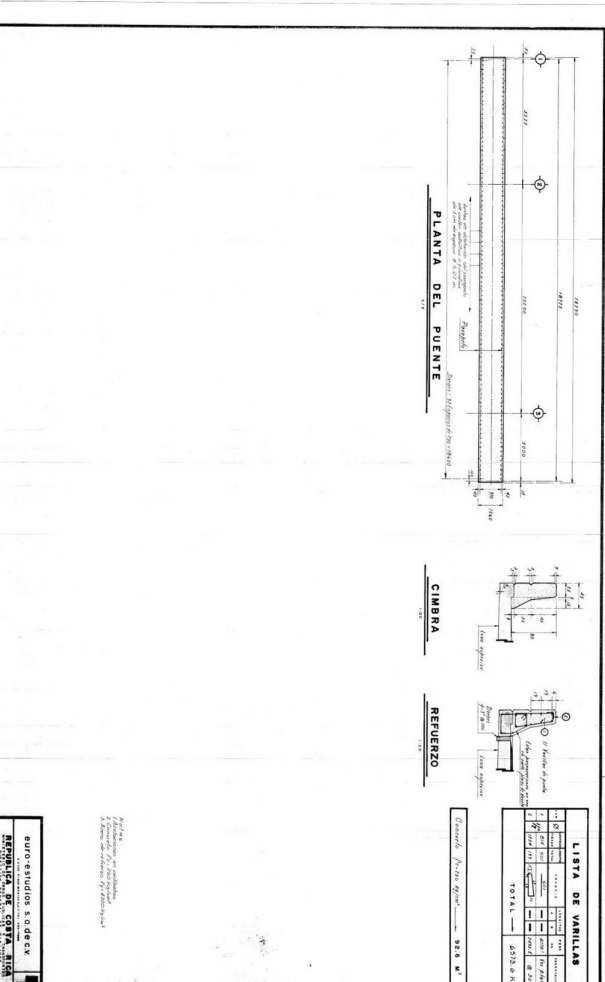

euro-estudios s.a de cv
REPUBLICA DE COSTA RICA
LISTA DE VARILLAS
CONCRETO ARMADO
27

euro-estudios s.a de cv
REPUBLICA DE COSTA RICA
LISTA DE VARILLAS
CONCRETO ARMADO
26

Anexo 2

Cabezal
 Placa: 103-9195
 Peso: 10 800 kg

Low boy
 Placa: 103-9211
 Peso: 12 300 kg

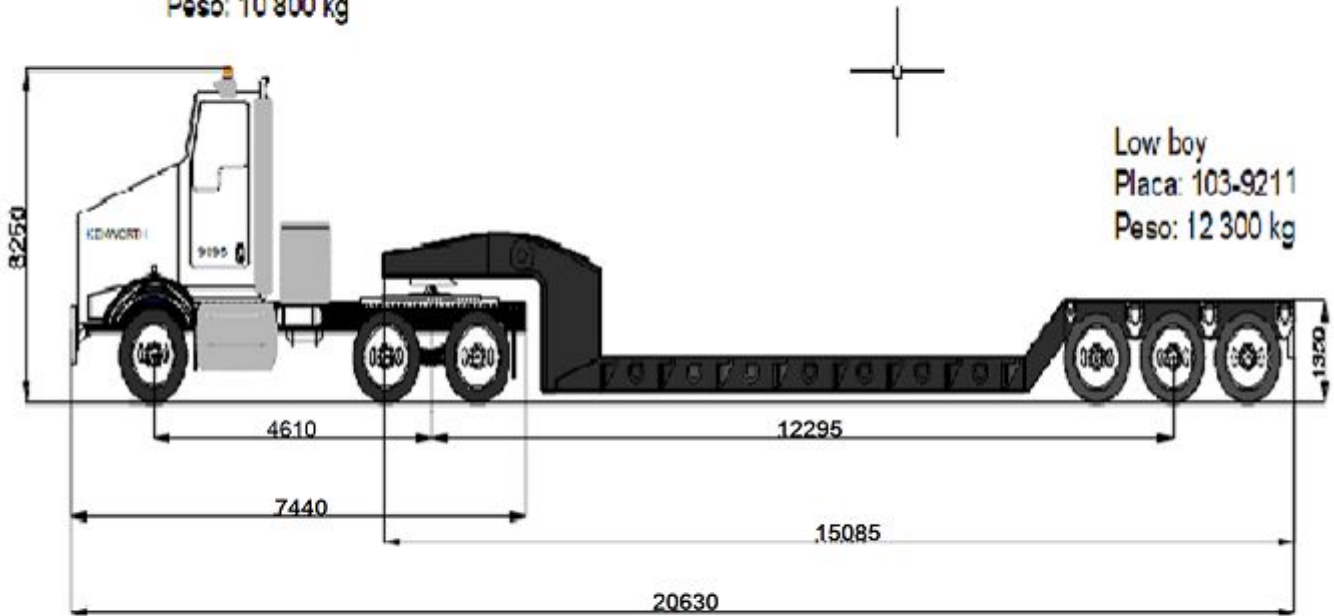

INSTITUTO COSTARRICENSE DE ELECTRICIDAD



SUB PROCESO GESTIÓN DE LA FLOTA
 ÁREA DE PLANIFICACIÓN Y
 ADQUISICIÓN DE VEHÍCULOS

Encargado del Área:
 Ing. Marlon Alfaro Guerrero

Firma _____

Coordinador de SETRAN:
 Lic. Guillermo Rojas Flores

Firma _____

Diseño e Inspección
 Jaime Barquero Bonilla

Firma _____

Coordinador Operativo
 Jorge Alvarez Herrera

Firma _____

Apéndice

Apéndice 1... Formulario de Inspección Visual

Apéndice 2... Cálculo de flexión de Superestructura

Apéndice 3... Cálculo de cortante en Superestructura

Apéndice 4... Cálculo de Flexo – Compresión en Pilas

Apéndice 5... Cálculo de Cortante en Pilas

Apéndice 6... Cálculos de Bastión

Apéndice 1

Cuadro 22. Formulario 0

Cuadro 22. Formulario 0		
Formulario 0	Información General	
ITEM	Sección	Descripción
Tipo de Ruta	5.2.1	Nacional
Nombre	5.2.2	Rio Sucio
Versión	5.2.3	-
Ruta	5.2.4	Primaria (1)
Numero Ruta	5.2.5	32
Kilometro	5.2.6	37
Localización	5.2.7	San José, Vásquez de Coronado, Dulce Nombre
Encargado	5.2.8	Zona 5-1 Guápiles
Sección de Control	5.2.9	1-feb
Código de Puente	5.2.10	-
Latitud Norte y Longitud Oeste	5.2.11	10°8'50.01" N -83°5652.72"O
Fecha de Diseño	5.2.12	11-jul-84
Fecha de Construcción	5.2.13	23-mar-87



Cuadro 23. Formulario 2





Cuadro 23. Formulario 2		
Formulario 2	Inventario básico del puente - Detalle de superestructura	
Ítem	Sección	Descripción
Numero de Superestructura	5.4.1	1
Número de Tramos	5.4.2	3
Alineación de Planta	5.4.3	(1) Recto
Material de Viga Principal	5.4.4	(2) Concreto Preesforzado
Superestructura	5.4.5	Viga Continua
Tipo de Viga Longitudinal	5.4.6	(4) Viga Cajón
Longitud Total	5.4.7	187.25m
Longitud de Tramo Máximo	5.4.8	102m
Numero de Vigas	5.4.9	1
Espaciamiento de vigas	5.4.10	-
Altura de viga	5.4.11	4.125m (Variada)
Tipo de Junta de expansión	5.4.12	Solo al final, tipo (4) Dentada
Material de Losa	5.4.13	Concreto
Espesor de Losa	5.4.14	20cm

Cuadro 24. Formulario 3

Formulario 3	Inventario Básico del Puente - Subestructura	
Ítem	Sección	Descripción
Numero de Subestructura	5.5.1	3
Nombre	5.5.2	Pilas y Bastión
Materiales	5.5.3	(1) Concreto
Tipo	5.5.4	(1) Gravedad
Altura	5.5.5	Bastión 1 (4.8m), Pila 1 (35.99m), pila 2 (7.18m)
Pila	5.5.6	Pila 1 (columna sencilla), Pila 2 (Muro)
Ancho y Largo	5.5.7	Bastión 1 (5.2x1.8)m, Pila 1 (Circular 5.2m Diámetro), Pila 2 (5.2x1.5)m
Tipo Fundación	5.5.8	(1) Placa Aislada
Ancho y Largo de Fundación	5.5.9	B1 (8x6.5)m, P1 (12.5x12.5)m, P2 (12.5x9)m
Tipo de Pilotes	5.5.10	-
Tipo de Apoyo	5.5.11	B1 (Movil), P1 (Fijo), P2 (Fijo)
Ancho de Asiento	5.5.12	B1 1.125m

Cuadro 25. Formulario 4

Formulario 4	Inventario Básico del Puente - Fotografías	
Fotografías Básicas	Sección	Descripción
Rotulo del Puente	3.4	 <p>Fuente: CIVCO (2015)</p>
Vista a lo largo de la línea centro	3.4	 <p>VISTA LÍNEA DE CENTRO</p> <p>Fuente: CIVCO (2015)</p>

<p>Perspectiva de todo el puente</p>	<p>3.4</p>	 <p>Fuente: CIVCO (2015)</p>
<p>Vista Lateral</p>	<p>3.4</p>	 <p>VISTA LATERAL</p> <p>Fuente: CIVCO (2015)</p>
<p>Vista Inferior</p>	<p>3.4</p>	 <p>Fuente: CIVCO (2015)</p>
<p>Vista del cauce del rio</p>	<p>3.4</p>	 <p>Fuente: Lamnamme (2009)</p>
<p>Bastiones</p>	<p>3.4</p>	 <p>Fuente: CIVCO (2015)</p>

Pilas

3.4



Fuente: CIVCO (2015)

Juntas de Expansión

3.4



Fuente: CIVCO (2015)

Apéndice 2

Ubicación [m]	FC [kg/cm2]	As [cm2]	Ac [cm2]	Fy [kg/cm2]	h [cm]	d [cm]	Mf [cm]	df [cm]	aps	Tipo (doble o sola)	Lx [cm]	0.3% o 0.15h	b [cm]	bw [cm]	Mf [cm]	Tornos	Apps x Tornos (cm)	Apps Total (cm)	Fs [kg/cm2]	Spo-20% Perdas (kg/cm2)	M aplicado [kg cm]	β1	0.65-β1-0.85	ρ	Azf [cm2]	ρf	ρb	pmn	As min	As - Asmin	α	C	CdE	cs	cc	Mn [kg cm]	Φ	Φ+Ms [kg m]	Mu	Mu/ΦMu																					
																						$\rho = \text{min} \left(\frac{0.008}{f_y}, 0.005 \right)$	$\beta = \text{As} \times d$	$Azf = 0.85 \times \left(\frac{M_f}{f_y} \right) \times (\beta - bw) \times hf$	$\rho_f = \frac{Azf}{b \times d \times hf}$	$\rho_b = \frac{0.85 \times f_c \times \beta \times hf}{f_y \times (b \times d \times hf)}$	$\rho = \text{min} \left(\frac{0.85 \times f_c \times \beta \times hf}{f_y \times (b \times d \times hf)}, \rho_b \right)$	$\rho_{pmn} = \frac{0.85 \times f_c \times \beta \times hf}{f_y \times (b \times d \times hf)}$	$\rho_{As \text{ min}} = \frac{M_f}{f_y \times (b \times d \times hf)}$	$\rho_{As - Asmin} = \rho - \rho_{As \text{ min}}$	$\alpha = \frac{A_{p \text{ aplic}} \times (b \times hf - A_{p \text{ aplic}} \times hf) \times (b \times hf)}{b \times hf \times hf}$	$C = \frac{d}{h}$	$CdE = \frac{d}{h}$	$cs = \frac{d}{h}$	$cc = \frac{d}{h}$	$M_n = Aps \times Fps \times \left(hf - \frac{d}{2} \right) + As \times Fy \times \left(hf - \frac{d}{2} \right) + A_s \times Fy \times \left(hf - \frac{d}{2} \right) - 0.85 f_c \times (b \times d - bw) \times hf \times \left(\frac{d}{2} - \frac{hf}{2} \right)$	AASHTO	$M_u = \Phi \times M_n$																							
0	350	32.071349	4	4300	240	225	40	20	192.00	Sola	5625	72	72	40	2	12.36	24.72	18000	14400	19989	0.8	0.8	0.00354343	90.6666667	0.00596708	0.039596708	356.370704	0.00999432	0.00953443	32.0713493	0	7.820812263	9.776	0.0494896	0.54	0.9	613.036.14	9.10.00	0.02																						
5	350	32.071349	4	4300	240	225	40	20	192.00	Sola	5625	72	72	40	2	12.36	24.72	18000	14400	19989	0.8	0.8	0.00354343	90.6666667	0.00596708	0.039596708	356.370704	0.00999432	0.00953443	32.0713493	0	7.820812263	9.776	0.0494896	0.54	0.9	613.036.14	9.10.00	0.02																						
10	350	32.071349	4	4300	240	225	40	20	192.00	Sola	5625	72	72	40	2	12.36	24.72	18000	14400	19989	0.8	0.8	0.00354343	90.6666667	0.00596708	0.039596708	356.370704	0.00999432	0.00953443	32.0713493	0	7.820812263	9.776	0.0494896	0.54	0.9	613.036.14	9.10.00	0.02																						
15	350	34.209439	4	4300	250	240	40	20	204.00	Sola	5625	76.5	76.5	40	2	12.36	24.72	18000	14400	1992887	0.8	0.8	0.00354343	103.4466667	0.00563716	0.039632716	380.4740741	0.00911668	0.00953443	34.2094396	0	4.07545224	5.043	0.0212621	0.76	0.9	687.89.06	1.70.857.00	19.19																						
20	350	34.209439	4	4300	250	240	40	20	204.00	Sola	5625	76	76	40	2	12.36	24.72	18000	14400	1499720	0.8	0.8	0.00354343	107.6666667	0.00563408	0.03963408	388.4740741	0.00911668	0.00953443	34.2094396	0	4.07545224	5.043	0.0212621	0.76	0.9	687.89.06	1.70.857.00	19.19																						
25	350	37.000226	4	4300	275	260	40	20	220.00	Sola	5625	82.5	82.5	40	2	12.36	24.72	18000	14400	907968	0.8	0.8	0.00354343	120.4466667	0.00541831	0.039611831	411.148	0.0044514	0.00953443	37.0002255	0	0.93407795	1.148	0.0044514	0.624	0.9	674.50.37	1.07.968.00	0.93																						
30	350	39.188151	4	4300	290	275	40	20	232.00	Sola	5625	87	87	40	2	12.36	24.72	18000	14400	1333088	0.8	0.8	0.00354343	133.6666667	0.00526605	0.03956605	435.2262036	0.00406267	0.00953443	39.1881508	0	4.66378784	5.83	0.021199	0.86	0.9	1.045.84.97	1.53.288.00	1.27																						
35	350	41.891002	4	4300	310	295	40	20	248.00	Sola	5625	106	106	40	2	12.36	24.72	18000	14400	2064768	0.8	0.8	0.00354343	206.8133333	0.00519954	0.03959954	485.8809867	0.00384813	0.00953443	41.8910016	0	29.1671788	37.07	0.016678	0.708	0.9	1.136.131.88	2.64.290.00	2.36																						
40	350	51.141158	4	4300	375	360	40	20	300.00	Doble	5625	225	225	40	2	12.36	24.72	18000	14400	4584824	0.8	0.8	0.00354343	458.4824	0.00323597	0.03923597	536.1929206	0.00323597	0.00953443	51.1411585	0	45.88760784	57.36	0.015932	0.868	0.9	1.644.548.40	4.34.471.00	3.17																						
45	350	55.801188	4	4300	405	390	40	20	324.00	Doble	5625	243	243	40	2	12.36	24.72	18000	14400	6387033	0.8	0.8	0.00354343	638.7033	0.00318484	0.039218484	577.7386033	0.00318484	0.00953443	55.8011883	0	55.1783798	68.72	0.0119885	0.916	0.9	1.931.037.61	6.30.700.00	4.00																						
50	350	64.142088	4	4300	460	450	40	20	372.00	Doble	5625	279	279	40	2	12.36	24.72	18000	14400	8800889	0.8	0.8	0.00354343	880.0889	0.00316801	0.039206801	660.542314	0.00316801	0.00953443	64.1420886	0	64.1420886	81.45	0.0088888	1.08	0.9	1.901.088.53	6.80.688.00	4.63																						
55.25	350	79.802044	4	4300	575	560	40	20	460.00	Doble	5625	345	345	40	2	12.36	24.72	18000	14400	12789977.9	0.8	0.8	0.00354343	1278.9977.9	0.00294596	0.039216456	811.6986384	0.00294596	0.00953443	79.8020425	0	95.8200826	119.8	0.0218973	1.344	0.9	2.505.299.12	11.853.296.00	6.10																						

Ubicación [m]	FC [kg/cm2]	As [cm2]	Ac [cm2]	Fy [kg/cm2]	h [cm]	d [cm]	Mf [cm]	df [cm]	aps	Tipo (doble o sola)	Lx [cm]	0.3% o 0.15h	b [cm]	bw [cm]	Mf [cm]	Tornos	Apps x Tornos (cm)	Apps Total (cm)	Fs [kg/cm2]	Spo-20% Perdas (kg/cm2)	M aplicado [kg cm]	β1	0.65-β1-0.85	ρ	Azf [cm2]	ρf	ρb	pmn	As min	As - Asmin	α	C	CdE	cs	cc	Mn [kg cm]	Φ	Mu [kg m]	Mu/ΦMu																						
																						$\rho = \text{min} \left(\frac{0.008}{f_y}, 0.005 \right)$	$\beta = As \times d$	$Azf = 0.85 \times \left(\frac{M_f}{f_y} \right) \times (\beta - bw) \times hf$	$\rho_f = \frac{Azf}{b \times d \times hf}$	$\rho_b = \frac{0.85 \times f_c \times \beta \times hf}{f_y \times (b \times d \times hf)}$	$\rho = \text{min} \left(\frac{0.85 \times f_c \times \beta \times hf}{f_y \times (b \times d \times hf)}, \rho_b \right)$	$\rho_{pmn} = \frac{0.85 \times f_c \times \beta \times hf}{f_y \times (b \times d \times hf)}$	$\rho_{As \text{ min}} = \frac{M_f}{f_y \times (b \times d \times hf)}$	$\rho_{As - Asmin} = \rho - \rho_{As \text{ min}}$	$\alpha = \frac{A_{p \text{ aplic}} \times (b \times hf - A_{p \text{ aplic}} \times hf) \times (b \times hf)}{b \times hf \times hf}$	$C = \frac{d}{h}$	$CdE = \frac{d}{h}$	$cs = \frac{d}{h}$	$cc = \frac{d}{h}$	$M_n = Aps \times Fps \times \left(hf - \frac{d}{2} \right) + As \times Fy \times \left(hf - \frac{d}{2} \right) + A_s \times Fy \times \left(hf - \frac{d}{2} \right) - 0.85 f_c \times (b \times d - bw) \times hf \times \left(\frac{d}{2} - \frac{hf}{2} \right)$	AASHTO	$M_u = \Phi \times M_n$																							
55.25	350	79.802044	4	4300	575	560	40	20	467.50	Sola	5625	172.50	172.5	40	2	12.36	24.72	18000	14400	12789977	0.8	0.8	0.00354343	1278.9977	0.00294596	0.039216456	811.6986384	0.00294596	0.00953443	79.8020425	0	95.8200826	119.8	0.0218973	1.344	0.9	2.016.010.61	11.833.296.00	6.34																						
60	350	79.802044	4	4300	575	560	40	20	467.50	Sola	5625	172.50	172.5	40	2	12.36	24.72	18000	14400	12789977	0.8	0.8	0.00354343	1278.9977	0.00294596	0.039216456	811.6986384	0.00294596	0.00953443	79.8020425	0	95.8200826	119.8	0.0218973	1.344	0.9	2.016.010.61	11.833.296.00	6.34																						
65	350	79.802044	4	4300	575	560	40	20	467.50	Sola	5625	172.50	172.5	40	2	12.36	24.72	18000	14400	12789977	0.8	0.8	0.00354343	1278.9977	0.00294596	0.039216456	811.6986384	0.00294596	0.00953443	79.8020425	0	95.8200826	119.8	0.0218973	1.344	0.9	2.016.010.61	11.833.296.00	6.34																						
70	350	85.938611	4	4300	627.5	612.5	40	20	517.94	Sola	5625	182.76	182.7647	40	2	12.36	24.72	18000	14400	2029176	0.8	0.8	0.00354343	2029.176	0.00447378	0.039447378	2391.7794334	0.00447378	0.00953443	85.9386115	0	55.0772487	61.85	0.0183308	1.06117647	0.9	1.643.939.82	2.829.178.00	1.83																						
75	350	85.938611	4	4300	627.5	612.5	40	20	517.94	Sola	5625	182.76	182.76	40	2	12.36	24.72	18000	14400	750291	0.8	0.8	0.00354343	750.291	0.00306366	0.03940366	832.3012888	0.00306366	0.00953443	85.9386115	0	43.2485026	47.20	0.008076	1.03081928	0.9	1.387.927.21	793.201.00	0.66																						
80	350	94.760217	4	4300	613.14	598.14	40	20	217.84	Doble	5627	247.88	247.8824	40	2	12.36	24.72	18000	14400	206648	0.8	0.8	0.00354343	2066.48	0.00484055	0.039484055	188.8892306	0.00484055	0.00953443	94.760217	0	56.7021117	69.26	0.0173669	0.95519412	0.9	1.217.994.89	945.048.00	1.08																						
85	350	94.760217	4	4300	613.14	598.14	40	20	217.84	Doble	5627	247.88	247.88	40	2	12.36	24.72	18000	14400	2417688	0.8	0.8	0.00354343	2417.688	0.00318806	0.039218806	345.121806	0.00318806	0.00953443	94.760217	0	47.1763998	59.47	0.0142099	0.86023284	0.9	1.423.386.56	2.477.088.00	3.58																						
90	350	94.760217	4	4300	613.14	598.14	40	20	217.84	Doble	5627	247.88	247.88	40	2	12.36	24.72	18000	14400	4420545	0.8	0.8	0.00354343	4420.545	0.00312057	0.039212057	509.7432804	0.00312057	0.00953443	94.760217	0	39.7432804	47.866573	0.01	0.8441172	0.80494176	0.9	1.425.045.00	4.48																						
95	350	94.760217	4	4300	613.14	598.14	40	20	217.84	Doble	5627	247.88	247.88	40	2	12.36	24.72	18000	14400	6091088	0.8	0.8	0.00354343	6091.088	0.00309615	0.039209615	658.239476	0.00309615	0.00953443	94.760217	0	31.8079178	39.89	0.0110994	0.79647059	0.9	670.262.54	5.001.088.00	0.81																						
100	350	98.862929	4	43																																																									

Apéndice 3

Cuadro 29. Cortante Tramo 1																										
Ubicación (m)	fc' (kg/cm2)	h	bw	dp	s	fy	Fps	A ps	Av min 1	Av min 2	Av min 3	Av	Vs Calculado	Vs MAX	Vs	Vc MIN	Vc Calculado	Vc Max	Vc	V	Φ	Ubicación (m)	Φ x Vn	V aplicado	Vu/ΦVn	
													$v_s = \frac{Av \times fy \times d}{s}$	$v_{sMAX} = 2.13 \times fy \times Av \times \sqrt{f'c}$		$v_c = 0.53 \times by \times dv \times \sqrt{f'c}$	$v_c = by \times dv \times (0.16\sqrt{f'c} + 49)$	$v_c = 0.25 \times by \times dv \times f'c$								
0	350	240	40	192	25	4,200.00	14,400.00	24.72	0.89	0.83	0.30	4.00	129,024.00	306,037.64	129,024.00	76,150.21	399,308.74	672,000.00	399,308.74	528,332.74	0.75	0.00	396,249.56	133,079.00	0.34	
5	350	240	40	192	25	4,200.00	14,400.00	24.72	0.89	0.83	0.30	4.00	129,024.00	306,037.64	129,024.00	76,150.21	399,308.74	672,000.00	399,308.74	528,332.74	0.75	5.00	396,249.56	79,648.00	0.20	
10	350	250	40	200	25	4,200.00	14,400.00	24.72	0.89	0.83	0.30	4.00	134,400.00	318,789.21	134,400.00	79,323.14	415,946.61	700,000.00	415,946.61	550,346.61	0.75	10.00	412,759.96	20,500.00	0.05	
15	350	250	40	200	25	4,200.00	14,400.00	24.72	0.89	0.83	0.30	4.00	134,400.00	318,789.21	134,400.00	79,323.14	415,946.61	700,000.00	415,946.61	550,346.61	0.75	15.00	412,759.96	50,105.00	0.12	
20	350	260	40	208	25	4,200.00	14,400.00	24.72	0.89	0.83	0.29	4.00	139,776.00	331,540.78	139,776.00	82,496.06	432,584.47	728,000.00	432,584.47	572,360.47	0.75	20.00	429,270.35	121,913.00	0.28	
25	350	275	40	220	25	4,200.00	14,400.00	24.72	0.89	0.83	0.28	4.00	147,840.00	350,668.13	147,840.00	87,255.45	457,541.27	770,000.00	457,541.27	605,381.27	0.75	25.00	454,035.95	191,165.00	0.42	
30	350	290	40	232	25	4,200.00	14,400.00	24.72	0.89	0.83	0.27	4.00	155,904.00	369,795.48	155,904.00	92,014.84	482,498.06	812,000.00	482,498.06	638,402.06	0.75	30.00	478,801.55	269,760.00	0.56	
35	350	310	40	248	25	4,200.00	14,400.00	24.72	0.89	0.83	0.27	4.00	166,656.00	395,298.62	166,656.00	98,360.69	515,773.79	868,000.00	515,773.79	682,429.79	0.75	35.00	511,822.34	346,045.00	0.68	
40	350	375	40	300	25	4,200.00	14,400.00	24.72	0.89	0.83	0.24	4.00	201,600.00	478,183.81	201,600.00	118,984.70	623,919.91	1,050,000.00	623,919.91	825,519.91	0.75	40.00	619,139.93	424,578.00	0.69	
45	350	405	40	324	25	4,200.00	14,400.00	24.72	0.89	0.83	0.23	4.00	217,728.00	516,438.52	217,728.00	128,503.48	673,833.50	1,134,000.00	673,833.50	891,561.50	0.75	45.00	668,671.13	505,736.00	0.76	
50	350	465	40	372	25	4,200.00	14,400.00	24.72	0.89	0.83	0.22	4.00	249,984.00	592,947.93	249,984.00	147,541.03	773,660.69	1,302,000.00	773,660.69	1,023,644.69	0.75	50.00	767,733.52	589,962.00	0.77	
55.25	350	575	40	460	25	4,200.00	14,400.00	24.72	0.89	0.83	0.20	4.00	309,120.00	733,215.18	309,120.00	182,443.21	956,677.20	1,610,000.00	956,677.20	1,265,797.20	0.75	55.25	949,347.90	679,370.00	0.72	

Cuadro 30. Cortante Tramo 2																									
Ubicación (m)	fc' (kg/cm2)	h	bw	dp	s	fy	Fps	A ps	Av min 1	Av min 2	Av min 3	Av min	Vs Calculado	Vs MAX	Vs	Vc MIN	Vc Calculado	Vc Max	Vc	V	Φ	Ubicación (m)	Φ x Vn	V aplicado	Vu/ΦVn
55.25	350	575.00	40	460.00	25	4,200.00	14,400.00	24.72	0.89	0.83	0.20	4.00	309,120.00	733,215.18	309,120.00	182,443.21	956,677.20	1,610,000.00	956,677.20	1,265,797.20	0.75	56.25	949,347.90	679,370.00	0.72
60	350	570.00	40	456.00	25	4,200.00	14,400.00	24.72	0.89	0.83	0.20	4.00	306,432.00	726,839.40	306,432.00	180,856.75	948,358.26	1,596,000.00	948,358.26	1,254,790.26	0.75	60.00	941,092.70	607,566.00	0.65
65	350	507.25	40	405.80	25	4,200.00	14,400.00	24.72	0.89	0.83	0.21	4.00	272,700.24	646,829.56	272,700.24	160,948.20	843,963.82	1,420,313.73	843,963.82	1,116,664.06	0.75	65.00	837,498.04	525,247.00	0.63
70	350	475.88	40	380.71	25	4,200.00	14,400.00	24.72	0.89	0.83	0.21	4.00	255,834.35	606,824.64	255,834.35	150,993.92	791,766.60	1,332,470.59	791,766.60	1,047,600.95	0.75	70.00	785,700.72	443,756.00	0.56
75	350	444.51	40	355.61	25	4,200.00	14,400.00	24.72	0.89	0.83	0.22	4.00	238,968.47	566,819.72	238,968.47	141,039.65	739,569.38	1,244,627.45	739,569.38	978,537.85	0.75	75.00	733,903.39	363,645.00	0.50
80	350	413.14	40	330.51	25	4,200.00	14,400.00	24.72	0.89	0.83	0.23	4.00	222,102.59	526,814.80	222,102.59	131,085.37	687,372.16	1,156,784.31	687,372.16	909,474.75	0.75	80.00	682,106.06	285,386.00	0.42
85	350	381.76	40	305.41	25	4,200.00	14,400.00	24.72	0.89	0.83	0.24	4.00	205,236.71	486,809.87	205,236.71	121,131.10	635,174.94	1,068,941.18	635,174.94	840,411.64	0.75	85.00	630,308.73	208,864.00	0.33
90	350	350.39	40	280.31	25	4,200.00	14,400.00	24.72	0.89	0.83	0.25	4.00	188,370.82	446,804.95	188,370.82	111,176.82	582,977.72	981,098.04	582,977.72	771,348.54	0.75	90.00	578,511.40	134,058.00	0.23
95	350	319.02	40	255.22	25	4,200.00	14,400.00	24.72	0.89	0.83	0.26	4.00	171,504.94	406,800.03	171,504.94	101,222.54	530,780.49	893,254.90	530,780.49	702,285.44	0.75	95.00	526,714.08	61,184.00	0.12
100	350	287.65	40	230.12	25	4,200.00	14,400.00	24.72	0.89	0.83	0.28	4.00	154,639.06	366,795.11	154,639.06	91,268.27	478,583.27	805,411.76	478,583.27	633,222.33	0.75	100.00	474,916.75	18,082.00	0.04
105	350	256.27	40	205.02	25	4,200.00	14,400.00	24.72	0.89	0.83	0.29	4.00	137,773.18	326,790.19	137,773.18	81,313.99	426,386.05	717,568.63	426,386.05	564,159.23	0.75	105.00	423,119.42	86,678.00	0.20
110	350	256.27	40	205.02	25	4,200.00	14,400.00	24.72	0.89	0.83	0.29	4.00	137,773.18	326,790.19	137,773.18	81,313.99	426,386.05	717,568.63	426,386.05	564,159.23	0.75	110.00	423,119.42	152,869.00	0.36
115	350	287.65	40	230.12	25	4,200.00	14,400.00	24.72	0.89	0.83	0.28	4.00	154,639.06	366,795.11	154,639.06	91,268.27	478,583.27	805,411.76	478,583.27	633,222.33	0.75	115.00	474,916.75	219,681.00	0.46
120	350	319.02	40	255.22	25	4,200.00	14,400.00	24.72	0.89	0.83	0.26	4.00	171,504.94	406,800.03	171,504.94	101,222.54	530,780.49	893,254.90	530,780.49	702,285.44	0.75	120.00	526,714.08	288,385.00	0.55
125	350	350.39	40	280.31	25	4,200.00	14,400.00	24.72	0.89	0.83	0.25	4.00	188,370.82	446,804.95	188,370.82	111,176.82	582,977.72	981,098.04	582,977.72	771,348.54	0.75	125.00	578,511.40	359,427.00	0.62
130	350	381.76	40	305.41	25	4,200.00	14,400.00	24.72	0.89	0.83	0.24	4.00	205,236.71	486,809.87	205,236.71	121,131.10	635,174.94	1,068,941.18	635,174.94	840,411.64	0.75	130.00	630,308.73	432,463.00	0.69
135	350	413.14	40	330.51	25	4,200.00	14,400.00	24.72	0.89	0.83	0.23	4.00	222,102.59	526,814.80	222,102.59	131,085.37	687,372.16	1,156,784.31	687,372.16	909,474.75	0.75	135.00	682,106.06	507,662.00	0.74
140	350	444.51	40	355.61	25	4,200.00	14,400.00	24.72	0.89	0.83	0.22	4.00	238,968.47	566,819.72	238,968.47	141,039.65	739,569.38	1,244,627.45	739,569.38	978,537.85	0.75	140.00	733,903.39	585,063.00	0.80
145	350	475.88	40	380.71	25	4,200.00	14,400.00	24.72	0.89	0.83	0.21	4.00	255,834.35	606,824.64	255,834.35	150,993.92	791,766.60	1,332,470.59	791,766.60	1,047,600.95	0.75	145.00	785,700.72	664,449.00	0.85
150	350	507.25	40	405.80	25	4,200.00	14,400.00	24.72	0.89	0.83	0.21	4.00	272,700.24	646,829.56	272,700.24	160,948.20	843,963.82	1,420,313.73	843,963.82	1,116,664.06	0.75	150.00	837,498.04	747,937.00	0.89
157.25	350	575.00	40	460.00	25	4,200.00	14,400.00	24.72	0.89	0.83	0.20	4.00	309,120.00	733,215.18	309,120.00	182,443.21	956,677.20	1,610,000.00	956,677.20	1,265,797.20	0.75	157.25	949,347.90	858,117.00	0.90

Cuadro 31. Cortante Tramo 3																									
Ubicación (m)	fc' (kg/cm2)	h (cm)	bw	dp	s	fy	Nu	A ps	Av min 1	Av min 2	Av min 3	Av min	Vs Calculado	Vs MAX	Vs	Vc MIN	Vc Calculado	Vc Max	Vc	V	Φ	Ubicación (m)	Φ x Vn	V aplicado	Vu/ΦVn
157.25	350	570	40	456	25	4,200.00	14,400.00	24.72	0.89	0.83	0.20	4.00	306,432.00	726,839.40	306,432.00	180,856.75	948,358.26	1,596,000.00	948,358.26	1,254,790.26	0.75	157.25	941,092.70	858,117.00	0.91
172.25	350	570	41	456	25	4,200.00	14,400.00	24.72	0.91	0.85	0.19	4.00	306,432.00	745,010.38	306,432.00	185,378.17	972,067.22	1,635,900.00	972,067.22	1,278,499.22	1.75	172.25	2,237,373.64	490,051.00	0.22
187.25	350	370	42	296	25	4,200.00	14,400.00	24.72	0.94	0.88	0.24	4.00	198,912.00	495,398.43	198,912.00	123,268.15	646,381.03	1,087,800.00	646,381.03	845,293.03	2.75	187.25	2,324,555.83	121,610.00	0.05

Apéndice 4

Información Previa		
Dato	Valor	Unidad
Pila	1	-
Fc'	280	kg/cm2
β1	0.85	-
εc	0.003	-
Fy	4200	kg/cm2
Es	2100000	kg/cm2
Ey	0.002	-
Recubrimiento	10	cm
Radio	260	cm
Diametro	520	cm
Ag	212371.66	cm2
As min	2123.72	cm2
Ast	2123.72	cm2
Ac	210,247.95	cm2
Peralte Efectivo d	510	cm
Cent Plast hcp	260	cm

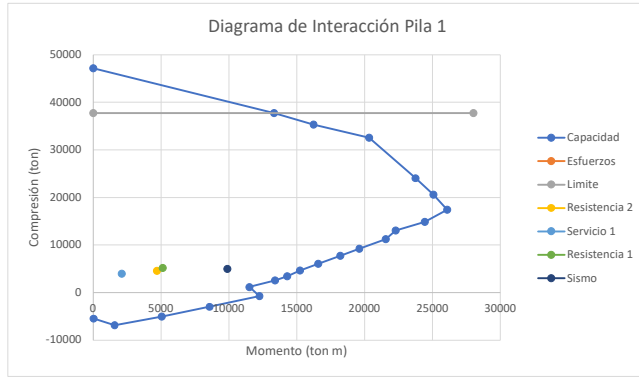

Cuadro Resumen		
C (cm)	P (ton)	M (ton m)
Compresión Pura		
-	47166.89695	0
Sobre Cb		
515	37785.04248	13317.43783
500	35314.83523	16238.33483
450	32590.06103	20325.33443
400	24052.48503	23735.90072
350	20596.8691	25055.2213
Balanceado		
306	17450.28866	26077.81814
Bajo Cb		
280	14844.99774	24436.63168
260	13039.20915	22277.89475
240	11247.07138	21558.15394
215	9210.06804	19603.67441
200	7728.826761	18197.56474
180	6072.948728	16574.48259
160	4628.310527	15234.76271
140	3468.124555	14302.88009
120	2548.929869	13386.92265
100	1183.970116	11502.0753
80	-734.7337573	12251.02862
60	-2986.727784	8572.152943
40	-5028.120069	5046.209653
20	-6842.765435	1571.104661
10	-5482.345432	32.39603334

Compresión Pura

Dato	Valor	Unidad
Po	58958.62119	ton
Pcu	47166.89695	ton
Pn max	38323.10377	ton
Pcu Max	30658.48302	ton

Dato	Valor	Unidad
Mo	0	ton m
Mcu	0	ton m
Mo Max	0	ton m
Mcu max	0	ton m

Falla Balanceada

Carga y Momentos Balanceados

Dato	Valor	Unidad
Cb	306	cm
ab=	260.1	cm
A comp=	106185.8317	cm2

Aporte del Concreto

Carga	P (ton)	M (ton m)
Valor	25272.22794	32841.26021

Aporte del Acero

Material	di	Brazo de Palanca	b	Condicion	Signo P	Signo M	As	es o ε's	εy	ε	fs	Aporte P (ton)	Aporte M (ton m)
As 1	10.00	250.00	142.83	Bajo	1.00	1.00	41.65	0.001	0.002	0.001	1,152.94	48.02	120.05
As 2	20.00	240.00	200.00	Bajo	1.00	1.00	41.65	0.001	0.002	0.001	1,358.82	56.60	135.83
As 3	30.00	230.00	242.49	Bajo	1.00	1.00	41.65	0.001	0.002	0.001	1,564.71	65.17	149.89
As 4	40.00	220.00	277.13	Bajo	1.00	1.00	41.65	0.001	0.002	0.001	1,770.59	73.75	162.24
As 5	50.00	210.00	306.59	Bajo	1.00	1.00	41.65	0.001	0.002	0.001	1,976.47	82.32	172.87
As 6	60.00	200.00	332.26	Bajo	1.00	1.00	41.65	0.001	0.002	0.001	2,182.35	90.90	181.79
As 7	70.00	190.00	354.96	Bajo	1.00	1.00	41.65	0.001	0.002	0.001	2,388.24	99.47	188.99
As 8	80.00	180.00	375.23	Bajo	1.00	1.00	41.65	0.001	0.002	0.001	2,594.12	108.05	194.48
As 9	90.00	170.00	393.45	Bajo	1.00	1.00	41.65	0.001	0.002	0.001	2,800.00	116.62	198.25
As 10	100.00	160.00	409.88	Bajo	1.00	1.00	41.65	0.001	0.002	0.001	3,005.88	125.20	200.31
As 11	110.00	150.00	424.74	Bajo	1.00	1.00	41.65	0.002	0.002	0.002	3,211.76	133.77	200.66
As 12	120.00	140.00	438.18	Bajo	1.00	1.00	41.65	0.002	0.002	0.002	3,417.65	142.35	199.28
As 13	130.00	130.00	450.33	Bajo	1.00	1.00	41.65	0.002	0.002	0.002	3,623.53	150.92	196.20
As 14	140.00	120.00	461.30	Bajo	1.00	1.00	41.65	0.002	0.002	0.002	3,829.41	159.50	191.39
As 15	150.00	110.00	471.17	Bajo	1.00	1.00	41.65	0.002	0.002	0.002	4,035.29	168.07	184.88
As 16	160.00	100.00	480.00	Bajo	1.00	1.00	41.65	0.002	0.002	0.002	4,200.00	174.93	174.93
As 17	170.00	90.00	487.85	Bajo	1.00	1.00	41.65	0.002	0.002	0.002	4,200.00	174.93	157.44
As 18	180.00	80.00	494.77	Bajo	1.00	1.00	41.65	0.002	0.002	0.002	4,200.00	174.93	139.94
As 19	190.00	70.00	500.80	Bajo	1.00	1.00	41.65	0.002	0.002	0.002	4,200.00	174.93	122.45
As 20	200.00	60.00	505.96	Bajo	1.00	1.00	41.65	0.002	0.002	0.002	4,200.00	174.93	104.96
As 21	210.00	50.00	510.29	Bajo	1.00	1.00	41.65	0.003	0.002	0.002	4,200.00	174.93	87.47
As 22	220.00	40.00	513.81	Bajo	1.00	1.00	41.65	0.003	0.002	0.002	4,200.00	174.93	69.97
As 23	230.00	30.00	516.53	Bajo	1.00	1.00	41.65	0.003	0.002	0.002	4,200.00	174.93	52.48
As 24	240.00	20.00	518.46	Bajo	1.00	1.00	41.65	0.003	0.002	0.002	4,200.00	174.93	34.99
As 25	250.00	10.00	519.62	Bajo	1.00	1.00	41.65	0.003	0.002	0.002	4,200.00	174.93	17.49
As 26	260.00	0.00	520.00	Bajo	1.00	1.00	41.65	0.003	0.002	0.002	4,200.00	174.93	0.00
As 27	270.00	10.00	519.62	Bajo	1.00	1.00	41.65	0.003	0.002	0.002	4,200.00	174.93	17.49
As 28	280.00	20.00	518.46	Bajo	1.00	1.00	41.65	0.003	0.002	0.002	4,200.00	174.93	34.99
As 29	290.00	30.00	516.53	Bajo	1.00	1.00	41.65	0.003	0.002	0.002	4,200.00	174.93	52.48
As 30	300.00	40.00	513.81	Bajo	1.00	1.00	41.65	0.003	0.002	0.002	4,200.00	174.93	69.97
As 31	310.00	50.00	510.29	Sobre	-1.00	1.00	41.65	0.003	0.002	0.002	4,200.00	-174.93	87.47
As 32	320.00	60.00	505.96	Sobre	-1.00	1.00	41.65	0.002	0.002	0.002	4,200.00	-174.93	104.96
As 33	330.00	70.00	500.80	Sobre	-1.00	1.00	41.65	0.002	0.002	0.002	4,200.00	-174.93	122.45
As 34	340.00	80.00	494.77	Sobre	-1.00	1.00	41.65	0.002	0.002	0.002	4,200.00	-174.93	139.94
As 35	350.00	90.00	487.85	Sobre	-1.00	1.00	41.65	0.002	0.002	0.002	4,200.00	-174.93	157.44
As 36	360.00	100.00	480.00	Sobre	-1.00	1.00	41.65	0.002	0.002	0.002	4,200.00	-174.93	174.93
As 37	370.00	110.00	471.17	Sobre	-1.00	1.00	41.65	0.002	0.002	0.002	4,035.29	-168.07	184.88
As 38	380.00	120.00	461.30	Sobre	-1.00	1.00	41.65	0.002	0.002	0.002	3,829.41	-159.50	191.39
As 39	390.00	130.00	450.33	Sobre	-1.00	1.00	41.65	0.002	0.002	0.002	3,623.53	-150.92	196.20
As 40	400.00	140.00	438.18	Sobre	-1.00	1.00	41.65	0.002	0.002	0.002	3,417.65	-142.35	199.28
As 41	410.00	150.00	424.74	Sobre	-1.00	1.00	41.65	0.002	0.002	0.002	3,211.76	-133.77	200.66
As 42	420.00	160.00	409.88	Sobre	-1.00	1.00	41.65	0.001	0.002	0.001	3,005.88	-125.20	200.31
As 43	430.00	170.00	393.45	Sobre	-1.00	1.00	41.65	0.001	0.002	0.001	2,800.00	-116.62	198.25
As 44	440.00	180.00	375.23	Sobre	-1.00	1.00	41.65	0.001	0.002	0.001	2,594.12	-108.05	194.48
As 45	450.00	190.00	354.96	Sobre	-1.00	1.00	41.65	0.001	0.002	0.001	2,388.24	-99.47	188.99
As 46	460.00	200.00	332.26	Sobre	-1.00	1.00	41.65	0.001	0.002	0.001	2,182.35	-90.90	181.79
As 47	470.00	210.00	306.59	Sobre	-1.00	1.00	41.65	0.001	0.002	0.001	1,976.47	-82.32	172.87
As 48	480.00	220.00	277.13	Sobre	-1.00	1.00	41.65	0.001	0.002	0.001	1,770.59	-73.75	162.24
As 49	490.00	230.00	242.49	Sobre	-1.00	1.00	41.65	0.001	0.002	0.001	1,564.71	-65.17	149.89
As 50	500.00	240.00	200.00	Sobre	-1.00	1.00	41.65	0.001	0.002	0.001	1,358.82	-56.60	135.83
As 51	510.00	250.00	142.83	Sobre	-1.00	1.00	41.65	0.001	0.002	0.001	1,152.94	-48.02	120.05
Aportes Totales del Acero												1,574.37	7,278.46

Cuadro Resumen			
C =			
	Concreto	Acero	Total
P (ton)	25272.22794	1,574.37	26,846.60
M (ton m)	32841.26021	7,278.46	40,119.72
Φ P (ton)			17450.28866
Φ M (ton m)			26077.81814

Valores Sobre el Cb

Carga y Momentos

Dato	Valor	Unidad
Cb	350	cm
a=	297.5	cm
Angulo =	163.4145254	grados
A comp=	125618.011	cm2

Aporte del Concreto

Carga	P (ton)	M (ton m)
Valor	29897.08661	33260.50886

Aporte del Acero

Material	di	Brazo de Palanca	b	Condicion	Signo P	Signo M	As	es o ε's	εy	ε	fs	Aporte P (ton)	Aporte M (ton m)
As 1	10.00	250.00	142.83	Bajo	1.00	1.00	41.65	0.001	0.002	0.001	1,800.00	74.97	187.43
As 2	20.00	240.00	200.00	Bajo	1.00	1.00	41.65	0.001	0.002	0.001	1,980.00	82.47	197.92
As 3	30.00	230.00	242.49	Bajo	1.00	1.00	41.65	0.001	0.002	0.001	2,160.00	89.96	206.92
As 4	40.00	220.00	277.13	Bajo	1.00	1.00	41.65	0.001	0.002	0.001	2,340.00	97.46	214.41
As 5	50.00	210.00	306.59	Bajo	1.00	1.00	41.65	0.001	0.002	0.001	2,520.00	104.96	220.41
As 6	60.00	200.00											

As 7	70.00	190.00	354.96	Bajo	1.00	1.00	41.65	0.001	0.002	0.001	2,880.00	119.95	227.91
As 8	80.00	180.00	375.23	Bajo	1.00	1.00	41.65	0.001	0.002	0.001	3,060.00	127.45	229.41
As 9	90.00	170.00	393.45	Bajo	1.00	1.00	41.65	0.002	0.002	0.002	3,240.00	134.95	229.41
As 10	100.00	160.00	409.88	Bajo	1.00	1.00	41.65	0.002	0.002	0.002	3,420.00	142.44	227.91
As 11	110.00	150.00	424.74	Bajo	1.00	1.00	41.65	0.002	0.002	0.002	3,600.00	149.94	224.91
As 12	120.00	140.00	438.18	Bajo	1.00	1.00	41.65	0.002	0.002	0.002	3,780.00	157.44	220.41
As 13	130.00	130.00	450.33	Bajo	1.00	1.00	41.65	0.002	0.002	0.002	3,960.00	164.93	214.41
As 14	140.00	120.00	461.30	Bajo	1.00	1.00	41.65	0.002	0.002	0.002	4,140.00	172.43	206.92
As 15	150.00	110.00	471.17	Bajo	1.00	1.00	41.65	0.002	0.002	0.002	4,200.00	174.93	192.42
As 16	160.00	100.00	480.00	Bajo	1.00	1.00	41.65	0.002	0.002	0.002	4,200.00	174.93	174.93
As 17	170.00	90.00	487.85	Bajo	1.00	1.00	41.65	0.002	0.002	0.002	4,200.00	174.93	157.44
As 18	180.00	80.00	494.77	Bajo	1.00	1.00	41.65	0.002	0.002	0.002	4,200.00	174.93	139.94
As 19	190.00	70.00	500.80	Bajo	1.00	1.00	41.65	0.002	0.002	0.002	4,200.00	174.93	122.45
As 20	200.00	60.00	505.96	Bajo	1.00	1.00	41.65	0.002	0.002	0.002	4,200.00	174.93	104.96
As 21	210.00	50.00	510.29	Bajo	1.00	1.00	41.65	0.003	0.002	0.002	4,200.00	174.93	87.47
As 22	220.00	40.00	513.81	Bajo	1.00	1.00	41.65	0.003	0.002	0.002	4,200.00	174.93	69.97
As 23	230.00	30.00	516.53	Bajo	1.00	1.00	41.65	0.003	0.002	0.002	4,200.00	174.93	52.48
As 24	240.00	20.00	518.46	Bajo	1.00	1.00	41.65	0.003	0.002	0.002	4,200.00	174.93	34.99
As 25	250.00	10.00	519.62	Bajo	1.00	1.00	41.65	0.003	0.002	0.002	4,200.00	174.93	17.49
As 26	260.00	0.00	520.00	Bajo	1.00	1.00	41.65	0.003	0.002	0.002	4,200.00	174.93	0.00
As 27	270.00	10.00	519.62	Bajo	1.00	1.00	41.65	0.003	0.002	0.002	4,200.00	174.93	17.49
As 28	280.00	20.00	518.46	Bajo	1.00	1.00	41.65	0.003	0.002	0.002	4,200.00	174.93	34.99
As 29	290.00	30.00	516.53	Bajo	1.00	1.00	41.65	0.003	0.002	0.002	4,200.00	174.93	52.48
As 30	300.00	40.00	513.81	Bajo	1.00	1.00	41.65	0.003	0.002	0.002	4,200.00	174.93	69.97
As 31	310.00	50.00	510.29	Bajo	1.00	-1.00	41.65	0.003	0.002	0.002	4,200.00	174.93	-87.47
As 32	320.00	60.00	505.96	Bajo	1.00	-1.00	41.65	0.002	0.002	0.002	4,200.00	174.93	-104.96
As 33	330.00	70.00	500.80	Bajo	1.00	-1.00	41.65	0.002	0.002	0.002	4,200.00	174.93	-122.45
As 34	340.00	80.00	494.77	Bajo	1.00	-1.00	41.65	0.002	0.002	0.002	4,200.00	174.93	-139.94
As 35	350.00	90.00	487.85	Bajo	1.00	-1.00	41.65	0.002	0.002	0.002	4,200.00	174.93	-157.44
As 36	360.00	100.00	480.00	Sobre	-1.00	1.00	41.65	0.002	0.002	0.002	4,200.00	-174.93	174.93
As 37	370.00	110.00	471.17	Sobre	-1.00	1.00	41.65	0.002	0.002	0.002	4,200.00	-174.93	192.42
As 38	380.00	120.00	461.30	Sobre	-1.00	1.00	41.65	0.002	0.002	0.002	4,140.00	-172.43	206.92
As 39	390.00	130.00	450.33	Sobre	-1.00	1.00	41.65	0.002	0.002	0.002	3,960.00	-164.93	214.41
As 40	400.00	140.00	438.18	Sobre	-1.00	1.00	41.65	0.002	0.002	0.002	3,780.00	-157.44	220.41
As 41	410.00	150.00	424.74	Sobre	-1.00	1.00	41.65	0.002	0.002	0.002	3,600.00	-149.94	224.91
As 42	420.00	160.00	409.88	Sobre	-1.00	1.00	41.65	0.002	0.002	0.002	3,420.00	-142.44	227.91
As 43	430.00	170.00	393.45	Sobre	-1.00	1.00	41.65	0.002	0.002	0.002	3,240.00	-134.95	229.41
As 44	440.00	180.00	375.23	Sobre	-1.00	1.00	41.65	0.001	0.002	0.001	3,060.00	-127.45	229.41
As 45	450.00	190.00	354.96	Sobre	-1.00	1.00	41.65	0.001	0.002	0.001	2,880.00	-119.95	227.91
As 46	460.00	200.00	332.26	Sobre	-1.00	1.00	41.65	0.001	0.002	0.001	2,700.00	-112.46	224.91
As 47	470.00	210.00	306.59	Sobre	-1.00	1.00	41.65	0.001	0.002	0.001	2,520.00	-104.96	220.41
As 48	480.00	220.00	277.13	Sobre	-1.00	1.00	41.65	0.001	0.002	0.001	2,340.00	-97.46	214.41
As 49	490.00	230.00	242.49	Sobre	-1.00	1.00	41.65	0.001	0.002	0.001	2,160.00	-89.96	206.92
As 50	500.00	240.00	200.00	Sobre	-1.00	1.00	41.65	0.001	0.002	0.001	1,980.00	-82.47	197.92
As 51	510.00	250.00	142.83	Sobre	-1.00	1.00	41.65	0.001	0.002	0.001	1,800.00	-74.97	187.43
Aportes Totales del Acero												3,323.67	7,151.14

Cuadro Resumen			
C =			
	Concreto	Acero	Total
P (ton)	29897.08661	3,323.67	33,220.76
M (ton m)	33260.50886	7,151.14	40,411.65
Φ P (ton)			20596.8691
Φ M (ton m)			25055.2213

Carga y Momentos C=400 cm

Dato	Valor	Unidad
Cb	400	cm
a =	340	cm
Angulo =	144.1595737	grados
A comp =	147119.7691	cm2

Aporte del Concreto

Carga	P (ton)	M (ton m)
Valor	35014.50505	31513.05454

Aporte del Acero

Material	di	Brazo de Palanca	b	Condicion	Signo P	Signo M	As	es o e's	ey	ε	fs	Aporte P (ton)	Aporte M (ton m)
As 1	10.00	250.00	142.83	Bajo	1.00	1.00	41.65	1.296	0.002	0.002	4,200.00	174.93	437.33
As 2	20.00	240.00	200.00	Bajo	1.00	1.00	41.65	1.296	0.002	0.002	4,200.00	174.93	419.83
As 3	30.00	230.00	242.49	Bajo	1.00	1.00	41.65	1.296	0.002	0.002	4,200.00	174.93	402.34
As 4	40.00	220.00	277.13	Bajo	1.00	1.00	41.65	1.296	0.002	0.002	4,200.00	174.93	384.85
As 5	50.00	210.00	306.59	Bajo	1.00	1.00	41.65	1.297	0.002	0.002	4,200.00	174.93	367.35
As 6	60.00	200.00	332.26	Bajo	1.00	1.00	41.65	1.297	0.002	0.002	4,200.00	174.93	349.86
As 7	70.00	190.00	354.96	Bajo	1.00	1.00	41.65	1.297	0.002	0.002	4,200.00	174.93	332.37
As 8	80.00	180.00	375.23	Bajo	1.00	1.00	41.65	1.297	0.002	0.002	4,200.00	174.93	314.87
As 9	90.00	170.00	393.45	Bajo	1.00	1.00	41.65	1.297	0.002	0.002	4,200.00	174.93	297.38
As 10	100.00	160.00	409.88	Bajo	1.00	1.00	41.65	1.297	0.002	0.002	4,200.00	174.93	279.89
As 11	110.00	150.00	424.74	Bajo	1.00	1.00	41.65	1.297	0.002	0.002	4,200.00	174.93	262.40
As 12	120.00	140.00	438.18	Bajo	1.00	1.00	41.65	1.297	0.002	0.002	4,200.00	174.93	244.90
As 13	130.00	130.00	450.33	Bajo	1.00	1.00	41.65	1.297	0.002	0.002	4,200.00	174.93	227.41
As 14	140.00	120.00	461.30	Bajo	1.00	1.00	41.65	1.297	0.002	0.002	4,200.00	174.93	209.92
As 15	150.00	110.00	471.17	Bajo	1.00	1.00	41.65	1.297	0.002	0.002	4,200.00	174.93	192.42
As 16	160.00	100.00	480.00	Bajo	1.00	1.00	41.65	1.297	0.002	0.002	4,200.00	174.93	174.93
As 17	170.00	90.00	487.85	Bajo	1.00	1.00	41.65	1.297	0.002	0.002	4,200.00	174.93	157.44
As 18	180.00	80.00	494.77	Bajo	1.00	1.00	41.65	1.298	0.002	0.002	4,200.00	174.93	139.94
As 19	190.00	70.00	500.80	Bajo	1.00	1.00	41.65	1.298	0.002	0.002	4,200.00	174.93	122.45
As 20	200.00	60.00	505.96	Bajo	1.00	1.00	41.65	1.298	0.002	0.002	4,200.00	174.93	104.96
As 21	210.00	50.00	510.29	Bajo	1.00	1.00	41.65	1.298	0.002	0.002	4,200.00	174.93	87.47
As 22	220.00	40.00	513.81	Bajo	1.00	1.00	41.65	1.298	0.002	0.002	4,200.00	174.93	69.97
As 23	230.00	30.00	516.53	Bajo	1.00	1.00	41.65	1.298	0.002	0.002	4,200.00	174.93	52.48
As 24	240.00	20.00	518.46	Bajo	1.00	1.00	41.65	1.298	0.002	0.002	4,200.00	174.93	34.99
As 25	250.00	10.00	519.62	Bajo	1.00	1.00	41.65	1.298	0.002	0.002	4,200.00	174.93	17.49
As 26	260.00	0.00	520.00	Bajo	1.00	1.00	41.65	1.298	0.002	0.002	4,200.00	174.93	0.00
As 27	270.00	10.00	519.62	Bajo	1.00	1.00	41.65	1.298	0.002	0.002	4,200.00	174.93	17.49
As 28	280.00	20.00	518.46	Bajo	1.00	1.00	41.65	1.298	0.002	0.002	4,200.00	174.93	34.99
As 29	290.00	30.00	516.53	Bajo	1.00	1.00	41.65	1.298	0.002	0.002	4,200.00	174.93	52.48
As 30	300.00	40.00	513.81	Bajo	1.00	1.00	41.65	1.298	0.002	0.002	4,200.00	174.93	69.97
As 31	310.00	50.00	510.29	Bajo	1.00	-1.00	41.65	1.298	0.002	0.002	4,200.00	174.93	-87.47
As 32	320.00	60.00	505.96	Bajo	1.00	-1.00	41.65	1.298	0.002	0.002	4,200.00	174.93	-104.96
As 33	330.00	70.00	500.80	Bajo	1.00	-1.00	41.65	1.298	0.002	0.002	4,200.00	174.93	-122.45
As 34	340.00	80.00	494.77	Bajo	1.00	-1.00	41.65	1.298	0.002	0.002	4,200.00	174.93	-139

Aporte del Acero

Material	di	Brazo de Palanca	b	Condicion	Signo P	Signo M	As	es o e's	ey	ε	fs	Aporte P (ton)	Aporte M (ton m)
As 1	10.00	250.00	142.83	Bajo	1.00	1.00	41.65	0.001	0.002	0.001	2,800.00	116.62	291.55
As 2	20.00	240.00	200.00	Bajo	1.00	1.00	41.65	0.001	0.002	0.001	2,940.00	122.45	293.88
As 3	30.00	230.00	242.49	Bajo	1.00	1.00	41.65	0.001	0.002	0.001	3,080.00	128.28	295.05
As 4	40.00	220.00	277.13	Bajo	1.00	1.00	41.65	0.002	0.002	0.002	3,220.00	134.11	295.05
As 5	50.00	210.00	306.59	Bajo	1.00	1.00	41.65	0.002	0.002	0.002	3,360.00	139.94	293.88
As 6	60.00	200.00	332.26	Bajo	1.00	1.00	41.65	0.002	0.002	0.002	3,500.00	145.78	291.55
As 7	70.00	190.00	354.96	Bajo	1.00	1.00	41.65	0.002	0.002	0.002	3,640.00	151.61	288.05
As 8	80.00	180.00	375.23	Bajo	1.00	1.00	41.65	0.002	0.002	0.002	3,780.00	157.44	283.39
As 9	90.00	170.00	393.45	Bajo	1.00	1.00	41.65	0.002	0.002	0.002	3,920.00	163.27	277.56
As 10	100.00	160.00	409.88	Bajo	1.00	1.00	41.65	0.002	0.002	0.002	4,060.00	169.10	270.56
As 11	110.00	150.00	424.74	Bajo	1.00	1.00	41.65	0.002	0.002	0.002	4,200.00	174.93	262.40
As 12	120.00	140.00	438.18	Bajo	1.00	1.00	41.65	0.002	0.002	0.002	4,200.00	174.93	244.90
As 13	130.00	130.00	450.33	Bajo	1.00	1.00	41.65	0.002	0.002	0.002	4,200.00	174.93	227.41
As 14	140.00	120.00	461.30	Bajo	1.00	1.00	41.65	0.002	0.002	0.002	4,200.00	174.93	209.92
As 15	150.00	110.00	471.17	Bajo	1.00	1.00	41.65	0.002	0.002	0.002	4,200.00	174.93	192.42
As 16	160.00	100.00	480.00	Bajo	1.00	1.00	41.65	0.002	0.002	0.002	4,200.00	174.93	174.93
As 17	170.00	90.00	487.85	Bajo	1.00	1.00	41.65	0.002	0.002	0.002	4,200.00	174.93	157.44
As 18	180.00	80.00	494.77	Bajo	1.00	1.00	41.65	0.002	0.002	0.002	4,200.00	174.93	139.94
As 19	190.00	70.00	500.80	Bajo	1.00	1.00	41.65	0.003	0.002	0.002	4,200.00	174.93	122.45
As 20	200.00	60.00	505.96	Bajo	1.00	1.00	41.65	0.003	0.002	0.002	4,200.00	174.93	104.96
As 21	210.00	50.00	510.29	Bajo	1.00	1.00	41.65	0.003	0.002	0.002	4,200.00	174.93	87.47
As 22	220.00	40.00	513.81	Bajo	1.00	1.00	41.65	0.003	0.002	0.002	4,200.00	174.93	69.97
As 23	230.00	30.00	516.53	Bajo	1.00	1.00	41.65	0.003	0.002	0.002	4,200.00	174.93	52.48
As 24	240.00	20.00	518.46	Bajo	1.00	1.00	41.65	0.003	0.002	0.002	4,200.00	174.93	34.99
As 25	250.00	10.00	519.62	Bajo	1.00	1.00	41.65	0.003	0.002	0.002	4,200.00	174.93	17.49
As 26	260.00	0.00	520.00	Bajo	1.00	1.00	41.65	0.003	0.002	0.002	4,200.00	174.93	0.00
As 27	270.00	10.00	519.62	Bajo	1.00	1.00	41.65	0.003	0.002	0.002	4,200.00	174.93	17.49
As 28	280.00	20.00	518.46	Bajo	1.00	1.00	41.65	0.003	0.002	0.002	4,200.00	174.93	34.99
As 29	290.00	30.00	516.53	Bajo	1.00	1.00	41.65	0.003	0.002	0.002	4,200.00	174.93	52.48
As 30	300.00	40.00	513.81	Bajo	1.00	1.00	41.65	0.003	0.002	0.002	4,200.00	174.93	69.97
As 31	310.00	50.00	510.29	Bajo	1.00	-1.00	41.65	0.003	0.002	0.002	4,200.00	174.93	-87.47
As 32	320.00	60.00	505.96	Bajo	1.00	-1.00	41.65	0.003	0.002	0.002	4,200.00	174.93	-104.96
As 33	330.00	70.00	500.80	Bajo	1.00	-1.00	41.65	0.003	0.002	0.002	4,200.00	174.93	-122.45
As 34	340.00	80.00	494.77	Bajo	1.00	-1.00	41.65	0.002	0.002	0.002	4,200.00	174.93	-139.94
As 35	350.00	90.00	487.85	Bajo	1.00	-1.00	41.65	0.002	0.002	0.002	4,200.00	174.93	-157.44
As 36	360.00	100.00	480.00	Bajo	1.00	-1.00	41.65	0.002	0.002	0.002	4,200.00	174.93	-174.93
As 37	370.00	110.00	471.17	Bajo	1.00	-1.00	41.65	0.002	0.002	0.002	4,200.00	174.93	-192.42
As 38	380.00	120.00	461.30	Bajo	1.00	-1.00	41.65	0.002	0.002	0.002	4,200.00	174.93	-209.92
As 39	390.00	130.00	450.33	Bajo	1.00	-1.00	41.65	0.002	0.002	0.002	4,200.00	174.93	-227.41
As 40	400.00	140.00	438.18	Bajo	1.00	-1.00	41.65	0.002	0.002	0.002	4,200.00	174.93	-244.90
As 41	410.00	150.00	424.74	Bajo	1.00	-1.00	41.65	0.002	0.002	0.002	4,200.00	174.93	-262.40
As 42	420.00	160.00	409.88	Bajo	1.00	-1.00	41.65	0.002	0.002	0.002	4,060.00	169.10	-270.56
As 43	430.00	170.00	393.45	Bajo	1.00	-1.00	41.65	0.002	0.002	0.002	3,920.00	163.27	-277.56
As 44	440.00	180.00	375.23	Bajo	1.00	-1.00	41.65	0.002	0.002	0.002	3,780.00	157.44	-283.39
As 45	450.00	190.00	354.96	Bajo	1.00	-1.00	41.65	0.002	0.002	0.002	3,640.00	151.61	-288.05
As 46	460.00	200.00	332.26	Sobre	-1.00	1.00	41.65	0.002	0.002	0.002	3,500.00	-145.78	291.55
As 47	470.00	210.00	306.59	Sobre	-1.00	1.00	41.65	0.002	0.002	0.002	3,360.00	-139.94	293.88
As 48	480.00	220.00	277.13	Sobre	-1.00	1.00	41.65	0.002	0.002	0.002	3,220.00	-134.11	295.05
As 49	490.00	230.00	242.49	Sobre	-1.00	1.00	41.65	0.001	0.002	0.001	3,080.00	-128.28	295.05
As 50	500.00	240.00	200.00	Sobre	-1.00	1.00	41.65	0.001	0.002	0.001	2,940.00	-122.45	293.88
As 51	510.00	250.00	142.83	Sobre	-1.00	1.00	41.65	0.001	0.002	0.001	2,800.00	-116.62	291.55
Aportes Totales del Acero												6,705.65	3,871.78

Aportes Totales del Acero

Cuadro Resumen			
C =			
	Concreto	Acero	Total
P (ton)	39851.58004	6,705.65	46,557.23
M (ton m)	27397.96128	3,871.78	31,269.75
Φ P (ton)			32590.06103
Φ M (ton m)			20325.33443

Carga y Momentos C=500 cm

Dato	Valor	Unidad
Cb	500	cm
a	425	cm
Angulo =	101.2170718	grados
A comp=	185815.8847	cm2

Aporte del Concreto

Carga	P (ton)	M (ton m)
Valor	44224.18057	21006.48577

Aporte del Acero

Material	di	Brazo de Palanca	b	Condicion	Signo P	Signo M	As	es o e's	ey	ε	fs	Aporte P (ton)	Aporte M (ton m)
As 1	10.00	250.00	142.83	Bajo	1.00	1.00	41.65	0.001	0.002	0.001	3,001.76	125.02	312.56
As 2	20.00	240.00	200.00	Bajo	1.00	1.00	41.65	0.001	0.002	0.001	2,875.76	119.78	287.46
As 3	30.00	230.00	242.49	Bajo	1.00	1.00	41.65	0.001	0.002	0.001	2,749.76	114.53	263.41
As 4	40.00	220.00	277.13	Bajo	1.00	1.00	41.65	0.001	0.002	0.001	2,623.76	109.28	240.42
As 5	50.00	210.00	306.59	Bajo	1.00	1.00	41.65	0.001	0.002	0.001	2,497.76	104.03	218.47
As 6	60.00	200.00	332.26	Bajo	1.00	1.00	41.65	0.001	0.002	0.001	2,371.76	98.78	197.57
As 7	70.00	190.00	354.96	Bajo	1.00	1.00	41.65	0.001	0.002	0.001	2,245.76	93.54	177.72
As 8	80.00	180.00	375.23	Bajo	1.00	1.00	41.65	0.001	0.002	0.001	2,119.76	88.29	158.92
As 9	90.00	170.00	393.45	Bajo	1.00	1.00	41.65	0.001	0.002	0.001	1,993.76	83.04	141.17
As 10	100.00	160.00	409.88	Bajo	1.00	1.00	41.65	0.001	0.002	0.001	1,867.76	77.79	124.47
As 11	110.00	150.00	424.74	Bajo	1.00	1.00	41.65	0.001	0.002	0.001	1,741.76	72.54	108.82
As 12	120.00	140.00	438.18	Bajo	1.00	1.00	41.65	0.001	0.002	0.001	1,615.76	67.30	94.22
As 13	130.00	130.00	450.33	Bajo	1.00	1.00	41.65	0.001	0.002	0.001	1,489.76	62.05	80.66
As 14	140.00	120.00	461.30	Bajo	1.00	1.00	41.65	0.001	0.002	0.001	1,363.76	56.80	68.16
As 15	150.00	110.00	471.17	Bajo	1.00	1.00	41.65	0.001	0.002	0.001	1,237.76	51.55	56.71
As 16	160.00	100.00	480.00	Bajo	1.00	1.00	41.65	0.001	0.002	0.001	1,111.76	46.31	46.31
As 17	170.00	90.00	487.85	Bajo	1.00	1.00	41.65	0.000	0.002	0.000	985.76	41.06	36.95
As 18	180.00	80.00	494.77	Bajo	1.00	1.00	41.65	0.000	0.002	0.000	859.76	35.81	28.65
As 19	190.00	70.00	500.80	Bajo	1.00	1.00	41.65	0.000	0.002	0.000	733.76	30.56	21.39
As 20	200.00	60.00	505.96	Bajo	1.00	1.00	41.65	0.000	0.002	0.000	607.76	25.31	15.19
As 21	210.00	50.00	510.29	Bajo	1.00	1.00	41.65	0.000	0.002	0.000	481.76	20.07	10.03
As 22	220.00	40.00	513.81	Bajo	1.00	1.00	41.65	0.000	0.002	0.000	355.76	14.82	5.93
As 23	230.00	30.00	516.53	Bajo	1.00	1.00	41.65	0.000	0.002	0.000	229.76	9.57	2.87
As 24	240.00	20.00	518.46	Bajo	1.00	1.00	41.65	0.000	0.002	0.000	103.76	4.32	0.86
As 25	250.00	10.00	519.62	Bajo	1.00	1.00	41.65	0.000	0.002	0.000	22.24	0.93	0.09
As 26	260.00	0.00	520.00	Bajo	1.00	1.00	41.65	0.000	0.002	0.000	148.24	6.	

a	437.75	cm
Angulo =	93.74033695	grados
A comp=	190800.2471	cm2

Aporte del Concreto

Carga	P (ton)	M (ton m)
Valor	45410.45881	18675.05119

Aporte del Acero

Material	di	Brazo de Palanca	b	Condicion	Signo P	Signo M	As	es o e's	ey	ε	fs	Aporte P (ton)	Aporte M (ton m)
As 1	10.00	250.00	142.83	Bajo	1.00	1.00	41.65	0.002	0.002	0.002	3,241.75	135.02	337.55
As 2	20.00	240.00	200.00	Bajo	1.00	1.00	41.65	0.002	0.002	0.002	3,364.08	140.11	336.27
As 3	30.00	230.00	242.49	Bajo	1.00	1.00	41.65	0.002	0.002	0.002	3,486.41	145.21	333.98
As 4	40.00	220.00	277.13	Bajo	1.00	1.00	41.65	0.002	0.002	0.002	3,608.74	150.30	330.67
As 5	50.00	210.00	306.59	Bajo	1.00	1.00	41.65	0.002	0.002	0.002	3,731.07	155.40	326.34
As 6	60.00	200.00	332.26	Bajo	1.00	1.00	41.65	0.002	0.002	0.002	3,853.40	160.49	320.99
As 7	70.00	190.00	354.96	Bajo	1.00	1.00	41.65	0.002	0.002	0.002	3,975.73	165.59	314.62
As 8	80.00	180.00	375.23	Bajo	1.00	1.00	41.65	0.002	0.002	0.002	4,098.06	170.68	307.23
As 9	90.00	170.00	393.45	Bajo	1.00	1.00	41.65	0.002	0.002	0.002	4,200.00	174.93	297.38
As 10	100.00	160.00	409.88	Bajo	1.00	1.00	41.65	0.002	0.002	0.002	4,200.00	174.93	279.89
As 11	110.00	150.00	424.74	Bajo	1.00	1.00	41.65	0.002	0.002	0.002	4,200.00	174.93	262.40
As 12	120.00	140.00	438.18	Bajo	1.00	1.00	41.65	0.002	0.002	0.002	4,200.00	174.93	244.90
As 13	130.00	130.00	450.33	Bajo	1.00	1.00	41.65	0.002	0.002	0.002	4,200.00	174.93	227.41
As 14	140.00	120.00	461.30	Bajo	1.00	1.00	41.65	0.002	0.002	0.002	4,200.00	174.93	209.92
As 15	150.00	110.00	471.17	Bajo	1.00	1.00	41.65	0.002	0.002	0.002	4,200.00	174.93	192.42
As 16	160.00	100.00	480.00	Bajo	1.00	1.00	41.65	0.002	0.002	0.002	4,200.00	174.93	174.93
As 17	170.00	90.00	487.85	Bajo	1.00	1.00	41.65	0.002	0.002	0.002	4,200.00	174.93	157.44
As 18	180.00	80.00	494.77	Bajo	1.00	1.00	41.65	0.003	0.002	0.002	4,200.00	174.93	139.94
As 19	190.00	70.00	500.80	Bajo	1.00	1.00	41.65	0.003	0.002	0.002	4,200.00	174.93	122.45
As 20	200.00	60.00	505.96	Bajo	1.00	1.00	41.65	0.003	0.002	0.002	4,200.00	174.93	104.96
As 21	210.00	50.00	510.29	Bajo	1.00	1.00	41.65	0.003	0.002	0.002	4,200.00	174.93	87.47
As 22	220.00	40.00	513.81	Bajo	1.00	1.00	41.65	0.003	0.002	0.002	4,200.00	174.93	69.97
As 23	230.00	30.00	516.53	Bajo	1.00	1.00	41.65	0.003	0.002	0.002	4,200.00	174.93	52.48
As 24	240.00	20.00	518.46	Bajo	1.00	1.00	41.65	0.003	0.002	0.002	4,200.00	174.93	34.99
As 25	250.00	10.00	519.62	Bajo	1.00	1.00	41.65	0.003	0.002	0.002	4,200.00	174.93	17.49
As 26	260.00	0.00	520.00	Bajo	1.00	1.00	41.65	0.003	0.002	0.002	4,200.00	174.93	0.00
As 27	270.00	10.00	519.62	Bajo	1.00	1.00	41.65	0.003	0.002	0.002	4,200.00	174.93	17.49
As 28	280.00	20.00	518.46	Bajo	1.00	1.00	41.65	0.003	0.002	0.002	4,200.00	174.93	34.99
As 29	290.00	30.00	516.53	Bajo	1.00	1.00	41.65	0.003	0.002	0.002	4,200.00	174.93	52.48
As 30	300.00	40.00	513.81	Bajo	1.00	1.00	41.65	0.003	0.002	0.002	4,200.00	174.93	69.97
As 31	310.00	50.00	510.29	Bajo	1.00	-1.00	41.65	0.003	0.002	0.002	4,200.00	174.93	-87.47
As 32	320.00	60.00	505.96	Bajo	1.00	-1.00	41.65	0.003	0.002	0.002	4,200.00	174.93	-104.96
As 33	330.00	70.00	500.80	Bajo	1.00	-1.00	41.65	0.003	0.002	0.002	4,200.00	174.93	-122.45
As 34	340.00	80.00	494.77	Bajo	1.00	-1.00	41.65	0.003	0.002	0.002	4,200.00	174.93	-139.94
As 35	350.00	90.00	487.85	Bajo	1.00	-1.00	41.65	0.002	0.002	0.002	4,200.00	174.93	-157.44
As 36	360.00	100.00	480.00	Bajo	1.00	-1.00	41.65	0.002	0.002	0.002	4,200.00	174.93	-174.93
As 37	370.00	110.00	471.17	Bajo	1.00	-1.00	41.65	0.002	0.002	0.002	4,200.00	174.93	-192.42
As 38	380.00	120.00	461.30	Bajo	1.00	-1.00	41.65	0.002	0.002	0.002	4,200.00	174.93	-209.92
As 39	390.00	130.00	450.33	Bajo	1.00	-1.00	41.65	0.002	0.002	0.002	4,200.00	174.93	-227.41
As 40	400.00	140.00	438.18	Bajo	1.00	-1.00	41.65	0.002	0.002	0.002	4,200.00	174.93	-244.90
As 41	410.00	150.00	424.74	Bajo	1.00	-1.00	41.65	0.002	0.002	0.002	4,200.00	174.93	-262.40
As 42	420.00	160.00	409.88	Bajo	1.00	-1.00	41.65	0.002	0.002	0.002	4,200.00	174.93	-279.89
As 43	430.00	170.00	393.45	Bajo	1.00	-1.00	41.65	0.002	0.002	0.002	4,200.00	174.93	-297.38
As 44	440.00	180.00	375.23	Bajo	1.00	-1.00	41.65	0.002	0.002	0.002	4,098.06	170.68	-307.23
As 45	450.00	190.00	354.96	Bajo	1.00	-1.00	41.65	0.002	0.002	0.002	3,975.73	165.59	-314.62
As 46	460.00	200.00	332.26	Bajo	1.00	-1.00	41.65	0.002	0.002	0.002	3,853.40	160.49	-320.99
As 47	470.00	210.00	306.59	Bajo	1.00	-1.00	41.65	0.002	0.002	0.002	3,731.07	155.40	-326.34
As 48	480.00	220.00	277.13	Bajo	1.00	-1.00	41.65	0.002	0.002	0.002	3,608.74	150.30	-330.67
As 49	490.00	230.00	242.49	Bajo	1.00	-1.00	41.65	0.002	0.002	0.002	3,486.41	145.21	-333.98
As 50	500.00	240.00	200.00	Bajo	1.00	-1.00	41.65	0.002	0.002	0.002	3,364.08	140.11	-336.27
As 51	510.00	250.00	142.83	Bajo	1.00	-1.00	41.65	0.002	0.002	0.002	3,241.75	135.02	-337.55
Aportes Totales del Acero												8,568.17	349.86

Cuadro Resumen			
C =			
	Concreto	Acero	Total
P (ton)	45410.45881	8,568.17	53,978.63
M (ton m)	18675.05119	349.86	19,024.91
Φ P (ton)			37785.04248
Φ M (ton m)			13317.43783

Valores Bajo el Cb

Carga y Momentos C=280 cm

Dato	Valor	Unidad
C	280	cm
a	238	cm
Angulo =	170.2921833	grados
A comp=	93754.90783	cm2

Aporte del Concreto

Carga	P (ton)	M (ton m)
Valor	22313.66806	31462.27197

Aporte del Acero

Material	di	Brazo de Palanca	b	Condicion	Signo P	Signo M	As	es o e's	ey	ε	fs	Aporte P (ton)	Aporte M (ton m)
As 1	10.00	250.00	142.83	Bajo	1.00	1.00	41.65	0.000	0.002	0.000	675.00	28.11	70.28
As 2	20.00	240.00	200.00	Bajo	1.00	1.00	41.65	0.000	0.002	0.000	900.00	37.49	89.96
As 3	30.00	230.00	242.49	Bajo	1.00	1.00	41.65	0.001	0.002	0.001	1,125.00	46.86	107.77
As 4	40.00	220.00	277.13	Bajo	1.00	1.00	41.65	0.001	0.002	0.001	1,350.00	56.23	123.70
As 5	50.00	210.00	306.59	Bajo	1.00	1.00	41.65	0.001	0.002	0.001	1,575.00	65.60	137.76
As 6	60.00	200.00	332.26	Bajo	1.00	1.00	41.65	0.001	0.002	0.001	1,800.00	74.97	149.94
As 7	70.00	190.00	354.96	Bajo	1.00	1.00	41.65	0.001	0.002	0.001	2,025.00	84.34	160.25
As 8	80.00	180.00	375.23	Bajo	1.00	1.00	41.65	0.001	0.002	0.001	2,250.00	93.71	168.68
As 9	90.00	170.00	393.45	Bajo	1.00	1.00	41.65	0.001	0.002	0.001	2,475.00	103.08	175.24
As 10	100.00	160.00	409.88	Bajo	1.00	1.00	41.65	0.001	0.002	0.001	2,700.00	112.46	179.93
As 11	110.00	150.00	424.74	Bajo	1.00	1.00	41.65	0.001	0.002	0.001	2,925.00	121.83	182.74
As 12	120.00	140.00	438.18	Bajo	1.00	1.00	41.65	0.002	0.002	0.002	3,150.00	131.20	183.68
As 13	130.00	130.00	450.33	Bajo	1.00	1.00	41.65	0.002	0.002	0.002	3,375.00	140.57	182.74
As 14	140.00	120.00	461.30	Bajo	1.00	1.00	41.65	0.002	0.002	0.002	3,600.00	149.94	179.93
As 15	150.00	110.00	471.17	Bajo	1.00	1.00	41.65	0.002	0.002	0.002	3,825.00	159.31	175.24
As 16	160.00	100.00	480.00	Bajo	1.00	1.00	41.65	0.002	0.002	0.002	4,050.00	168.68	168.68
As 17	170.00	90.00	487.85	Bajo	1.00	1.00	41.65	0.002	0.002	0.002	4,200.00	174.93	157.44
As 18	180.00	80.00	494.77	Bajo	1.00	1.00	41.65	0.002	0.002	0.002	4,200.00	174.93	139.94
As 19	190.00	70.00	500.80	Bajo	1.00	1.00	41.65	0.002	0.002	0.002	4,200.00	174.93	122.45
As 20	200.00	60.00	505.96	Bajo	1.00	1.00	41.65	0.002	0.002	0.002	4,200.00	174.93	104.96
As 21	210.00	50.00	510.29	Bajo	1.00	1.00	41.65	0.002	0.002	0.002	4,200.00	174.93	87.47
As 22	220.00	40.00	513.81	Bajo	1.00	1.00	41.65	0.003	0.002	0.002	4,200.00	174.93	69.97
As 23	230.00	30.00	516.53	Bajo	1.00	1.00	41.65	0.003	0.002	0.002	4,200.00	174.93	52.48
As 24	240.00												

Cuadro Resumen			
C =			
	Concreto	Acero	Total
P (ton)	22313.66806	524.79	22,838.46
M (ton m)	31462.27197	6,132.55	37,594.82
Φ P (ton)			14844.99774
Φ M (ton m)			24436.63168

Carga y Momentos C=260 cm

Dato	Valor	Unidad
C	260	cm
a	221	cm
Angulo =	162.7461469	grados
A comp=	85022.06628	cm2

Aporte del Concreto

Carga	P (ton)	M (ton m)
Valor	20235.25177	30251.7014

Aporte del Acero

Material	di	Brazo de Palanca	b	Condicion	Signo P	Signo M	As	es o e's	εy	ε	fs	Aporte P (ton)	Aporte M (ton m)
As 1	10.00	250.00	142.83	Bajo	1.00	1.00	41.65	0.001	0.002	0.001	1,926.00	80.22	200.54
As 2	20.00	240.00	200.00	Bajo	1.00	1.00	41.65	0.001	0.002	0.001	1,596.96	66.51	159.63
As 3	30.00	230.00	242.49	Bajo	1.00	1.00	41.65	0.001	0.002	0.001	1,267.92	52.81	121.46
As 4	40.00	220.00	277.13	Bajo	1.00	1.00	41.65	0.000	0.002	0.000	938.88	39.10	86.03
As 5	50.00	210.00	306.59	Bajo	1.00	1.00	41.65	0.000	0.002	0.000	609.84	25.40	53.34
As 6	60.00	200.00	332.26	Bajo	1.00	1.00	41.65	0.000	0.002	0.000	280.80	11.70	23.39
As 7	70.00	190.00	354.96	Bajo	1.00	1.00	41.65	0.000	0.002	0.000	48.24	2.01	3.82
As 8	80.00	180.00	375.23	Bajo	1.00	1.00	41.65	0.000	0.002	0.000	377.28	15.71	28.28
As 9	90.00	170.00	393.45	Bajo	1.00	1.00	41.65	0.000	0.002	0.000	706.32	29.42	50.01
As 10	100.00	160.00	409.88	Bajo	1.00	1.00	41.65	0.000	0.002	0.000	1,035.36	43.12	69.00
As 11	110.00	150.00	424.74	Bajo	1.00	1.00	41.65	0.001	0.002	0.001	1,364.40	56.83	85.24
As 12	120.00	140.00	438.18	Bajo	1.00	1.00	41.65	0.001	0.002	0.001	1,693.44	70.53	98.74
As 13	130.00	130.00	450.33	Bajo	1.00	1.00	41.65	0.001	0.002	0.001	2,022.48	84.24	109.51
As 14	140.00	120.00	461.30	Bajo	1.00	1.00	41.65	0.001	0.002	0.001	2,351.52	97.94	117.53
As 15	150.00	110.00	471.17	Bajo	1.00	1.00	41.65	0.001	0.002	0.001	2,680.56	111.65	122.81
As 16	160.00	100.00	480.00	Bajo	1.00	1.00	41.65	0.001	0.002	0.001	3,009.60	125.35	125.35
As 17	170.00	90.00	487.85	Bajo	1.00	1.00	41.65	0.002	0.002	0.002	3,338.64	139.05	125.15
As 18	180.00	80.00	494.77	Bajo	1.00	1.00	41.65	0.002	0.002	0.002	3,667.68	152.76	122.21
As 19	190.00	70.00	500.80	Bajo	1.00	1.00	41.65	0.002	0.002	0.002	3,996.72	166.46	116.52
As 20	200.00	60.00	505.96	Bajo	1.00	1.00	41.65	0.002	0.002	0.002	4,200.00	174.93	104.96
As 21	210.00	50.00	510.29	Bajo	1.00	1.00	41.65	0.002	0.002	0.002	4,200.00	174.93	87.47
As 22	220.00	40.00	513.81	Bajo	1.00	1.00	41.65	0.002	0.002	0.002	4,200.00	174.93	69.97
As 23	230.00	30.00	516.53	Bajo	1.00	1.00	41.65	0.003	0.002	0.002	4,200.00	174.93	52.48
As 24	240.00	20.00	518.46	Bajo	1.00	1.00	41.65	0.003	0.002	0.002	4,200.00	174.93	34.99
As 25	250.00	10.00	519.62	Bajo	1.00	1.00	41.65	0.003	0.002	0.002	4,200.00	174.93	17.49
As 26	260.00	0.00	520.00	Sobre	-1.00	-1.00	41.65	0.003	0.002	0.002	4,200.00	-174.93	0.00
As 27	270.00	10.00	519.62	Sobre	-1.00	-1.00	41.65	0.003	0.002	0.002	4,200.00	-174.93	-17.49
As 28	280.00	20.00	518.46	Sobre	-1.00	-1.00	41.65	0.003	0.002	0.002	4,200.00	-174.93	-34.99
As 29	290.00	30.00	516.53	Sobre	-1.00	-1.00	41.65	0.003	0.002	0.002	4,200.00	-174.93	-52.48
As 30	300.00	40.00	513.81	Sobre	-1.00	-1.00	41.65	0.002	0.002	0.002	4,200.00	-174.93	-69.97
As 31	310.00	50.00	510.29	Sobre	-1.00	1.00	41.65	0.002	0.002	0.002	4,200.00	-174.93	87.47
As 32	320.00	60.00	505.96	Sobre	-1.00	1.00	41.65	0.002	0.002	0.002	4,200.00	-174.93	104.96
As 33	330.00	70.00	500.80	Sobre	-1.00	1.00	41.65	0.002	0.002	0.002	3,996.72	-166.46	116.52
As 34	340.00	80.00	494.77	Sobre	-1.00	1.00	41.65	0.002	0.002	0.002	3,667.68	-152.76	122.21
As 35	350.00	90.00	487.85	Sobre	-1.00	1.00	41.65	0.002	0.002	0.002	3,338.64	-139.05	125.15
As 36	360.00	100.00	480.00	Sobre	-1.00	1.00	41.65	0.001	0.002	0.001	3,009.60	-125.35	125.35
As 37	370.00	110.00	471.17	Sobre	-1.00	1.00	41.65	0.001	0.002	0.001	2,680.56	-111.65	122.81
As 38	380.00	120.00	461.30	Sobre	-1.00	1.00	41.65	0.001	0.002	0.001	2,351.52	-97.94	117.53
As 39	390.00	130.00	450.33	Sobre	-1.00	1.00	41.65	0.001	0.002	0.001	2,022.48	-84.24	109.51
As 40	400.00	140.00	438.18	Sobre	-1.00	1.00	41.65	0.001	0.002	0.001	1,693.44	-70.53	98.74
As 41	410.00	150.00	424.74	Sobre	-1.00	1.00	41.65	0.001	0.002	0.001	1,364.40	-56.83	85.24
As 42	420.00	160.00	409.88	Sobre	-1.00	1.00	41.65	0.000	0.002	0.000	1,035.36	-43.12	69.00
As 43	430.00	170.00	393.45	Sobre	-1.00	1.00	41.65	0.000	0.002	0.000	706.32	-29.42	50.01
As 44	440.00	180.00	375.23	Sobre	-1.00	1.00	41.65	0.000	0.002	0.000	377.28	-15.71	28.28
As 45	450.00	190.00	354.96	Sobre	-1.00	1.00	41.65	0.000	0.002	0.000	48.24	-2.01	3.82
As 46	460.00	200.00	332.26	Sobre	-1.00	1.00	41.65	0.000	0.002	0.000	280.80	-11.70	23.39
As 47	470.00	210.00	306.59	Sobre	-1.00	1.00	41.65	0.000	0.002	0.000	609.84	-25.40	53.34
As 48	480.00	220.00	277.13	Sobre	-1.00	1.00	41.65	0.000	0.002	0.000	938.88	-39.10	86.03
As 49	490.00	230.00	242.49	Sobre	-1.00	1.00	41.65	0.001	0.002	0.001	1,267.92	-52.81	121.46
As 50	500.00	240.00	200.00	Sobre	-1.00	1.00	41.65	0.001	0.002	0.001	1,596.96	-66.51	159.63
As 51	510.00	250.00	142.83	Sobre	-1.00	1.00	41.65	0.001	0.002	0.001	1,926.00	-80.22	200.54
Aportes Totales del Acero												-174.93	4,021.98

Cuadro Resumen			
C =			
	Concreto	Acero	Total
P (ton)	20235.25177	-174.93	20,060.32
M (ton m)	30251.7014	4,021.98	34,273.68
Φ P (ton)			13039.20915
Φ M (ton m)			22277.89475

Carga y Momentos C=240 cm

Dato	Valor	Unidad
C	240	cm
a	204	cm
Angulo =	155.1238144	grados
A comp=	76377.46528	cm2

Aporte del Concreto

Carga	P (ton)	M (ton m)
Valor	18177.83674	28720.98204

Aporte del Acero

Material	di	Brazo de Palanca	b	Condicion	Signo P	Signo M	As	es o e's	εy	ε	fs	Aporte P (ton)	Aporte M (ton m)
As 1	10.00	250.00	142.83	Bajo	1.00	1.00	41.65	0.000	0.002	0.000	262.50	10.93	27.33
As 2	20.00	240.00	200.00	Bajo	1.00	1.00	41.65	0.000	0.002	0.000	0.00	0.00	0.00
As 3	30.00	230.00	242.49	Bajo	1.00	1.00	41.65	0.000	0.002	0.000	262.50	10.93	25.15
As 4	40.00	220.00	277.13	Bajo	1.00	1.00	41.65	0.000	0.002	0.000	525.00	21.87	48.11
As 5	50.00	210.00	306.59	Bajo	1.00	1.00	41.65	0.000	0.002	0.000	787.50	32.80	68.88
As 6	60.00	200.00	332.26	Bajo	1.00	1.00	41.65	0.001	0.002	0.001	1,050.00	43.73	87.47
As 7	70.00	190.00	354.96	Bajo	1.00	1.00	41.65	0.001	0.002	0.001	1,312.50	54.67	103.86
As 8	80.00	180.00	375.23	Bajo	1.00	1.00	41.65	0.001	0.002	0.001	1,575.00	65.60	118.08
As 9	90.00	170.00	393.45	Bajo	1.00	1.00	41.65	0.001	0.002	0.001	1,837.50	76.53	130.10
As 10	100.00	160.00	409.88	Bajo	1.00	1.00	41.65	0.001	0.002	0.001	2,100.00	87.47	139.94
As 11	110.00	150.00	424.74	Bajo	1.00	1.00	41.65	0.001	0.002	0.001	2,362.50	98.40	147.60
As 12	120.00	140.00	438.18	Bajo	1.00	1.00	41.65	0.001	0.002	0.001	2,625.00	109.33	153.06
As 13	130.00	130.00	450.33	Bajo	1.00	1.00	41.65	0.001	0.002	0.001	2,887.50	120.26	156.34
As 14	140.00	120.00	461.30	Bajo	1.00	1.00	41.65	0.002	0.002	0.002	3,150.00	131.20	157.44
As 15	150.00	110.00	471.17	Bajo	1.00	1.00	41.65	0.002	0.002	0.002	3,412.50	142.13	156.34
As 16	160.00	100.00	480.00	Bajo	1.00	1.00	41.65	0.002	0.002	0.002	3,675.00	153.06	153.06
As 17	170.00	90.00	487.85	Bajo	1.00	1.00	41.65	0.002	0.002	0.002	3,937.50	164.00	147.60
As 18	180.00	80.00	494.77	Bajo	1.00	1.00	41.65	0.002	0.002	0.002	4,200.00	174.93	139.94
As 19	190.00	70.00	500.80	Bajo	1.00	1.00	41.65	0.002	0.002	0.002	4,200.00	174.93	122.45
As 20	200.00	60.00	505.96	Bajo	1.00	1.00	41.65	0.002	0.002	0.002	4,200.00	174.93	104.96
As 21	210.00	50.00	510.29	Bajo	1.00	1.00	41.65	0.002	0.002	0.002	4,200.00	174.93	87.47
As 22	220.00												

As 42	420.00	160.00	409.88	Sobre	-1.00	1.00	41.65	0.001	0.002	0.001	2,100.00	-87.47	139.94
As 43	430.00	170.00	393.45	Sobre	-1.00	1.00	41.65	0.001	0.002	0.001	1,837.50	-76.53	130.10
As 44	440.00	180.00	375.23	Sobre	-1.00	1.00	41.65	0.001	0.002	0.001	1,575.00	-65.60	118.08
As 45	450.00	190.00	354.96	Sobre	-1.00	1.00	41.65	0.001	0.002	0.001	1,312.50	-54.67	103.86
As 46	460.00	200.00	332.26	Sobre	-1.00	1.00	41.65	0.001	0.002	0.001	1,050.00	-43.73	87.47
As 47	470.00	210.00	306.59	Sobre	-1.00	1.00	41.65	0.000	0.002	0.000	787.50	-32.80	68.88
As 48	480.00	220.00	277.13	Sobre	-1.00	1.00	41.65	0.000	0.002	0.000	525.00	-21.87	48.11
As 49	490.00	230.00	242.49	Sobre	-1.00	1.00	41.65	0.000	0.002	0.000	262.50	-10.93	25.15
As 50	500.00	240.00	200.00	Sobre	-1.00	1.00	41.65	0.000	0.002	0.000	0.00	0.00	0.00
As 51	510.00	250.00	142.83	Sobre	-1.00	1.00	41.65	0.000	0.002	0.000	262.50	-10.93	27.33
Aportes Totales del Acero											-874.65	4,445.41	

Cuadro Resumen			
C =			
	Concreto	Acero	Total
P (ton)	18177.83674	-874.65	17,303.19
M (ton m)	28720.98204	4,445.41	33,166.39
Φ P (ton)			11247.07138
Φ M (ton m)			21558.15394

Carga y Momentos C=215.9359 cm

Dato	Valor	Unidad
C	215.9359	cm
a	183.545515	cm
Angulo =	145.7981553	grados
A comp=	66150.02288	cm2

Aporte del Concreto

Carga	P (ton)	M (ton m)
Valor	15743.70545	26485.20154

Aporte del Acero

Material	di	Brazo de Palanca	b	Condicion	Signo P	Signo M	As	es o e's	ey	ε	fs	Aporte P (ton)	Aporte M (ton m)
As 1	10.00	250.00	142.83	Bajo	1.00	1.00	41.65	0.000	0.002	0.000	993.83	41.39	103.48
As 2	20.00	240.00	200.00	Bajo	1.00	1.00	41.65	0.000	0.002	0.000	702.08	29.24	70.18
As 3	30.00	230.00	242.49	Bajo	1.00	1.00	41.65	0.000	0.002	0.000	410.32	17.09	39.31
As 4	40.00	220.00	277.13	Bajo	1.00	1.00	41.65	0.000	0.002	0.000	118.57	4.94	10.86
As 5	50.00	210.00	306.59	Bajo	1.00	1.00	41.65	0.000	0.002	0.000	173.18	7.21	15.15
As 6	60.00	200.00	332.26	Bajo	1.00	1.00	41.65	0.000	0.002	0.000	464.94	19.36	38.73
As 7	70.00	190.00	354.96	Bajo	1.00	1.00	41.65	0.000	0.002	0.000	756.69	31.52	59.88
As 8	80.00	180.00	375.23	Bajo	1.00	1.00	41.65	0.000	0.002	0.000	1,048.44	43.67	78.60
As 9	90.00	170.00	393.45	Bajo	1.00	1.00	41.65	0.001	0.002	0.001	1,340.19	55.82	94.89
As 10	100.00	160.00	409.88	Bajo	1.00	1.00	41.65	0.001	0.002	0.001	1,631.95	67.97	108.75
As 11	110.00	150.00	424.74	Bajo	1.00	1.00	41.65	0.001	0.002	0.001	1,923.70	80.12	120.18
As 12	120.00	140.00	438.18	Bajo	1.00	1.00	41.65	0.001	0.002	0.001	2,215.45	92.27	129.18
As 13	130.00	130.00	450.33	Bajo	1.00	1.00	41.65	0.001	0.002	0.001	2,507.21	104.43	135.75
As 14	140.00	120.00	461.30	Bajo	1.00	1.00	41.65	0.001	0.002	0.001	2,798.96	116.58	139.89
As 15	150.00	110.00	471.17	Bajo	1.00	1.00	41.65	0.001	0.002	0.001	3,090.71	128.73	141.60
As 16	160.00	100.00	480.00	Bajo	1.00	1.00	41.65	0.002	0.002	0.002	3,382.47	140.88	140.88
As 17	170.00	90.00	487.85	Bajo	1.00	1.00	41.65	0.002	0.002	0.002	3,674.22	153.03	137.73
As 18	180.00	80.00	494.77	Bajo	1.00	1.00	41.65	0.002	0.002	0.002	3,965.97	165.18	132.15
As 19	190.00	70.00	500.80	Bajo	1.00	1.00	41.65	0.002	0.002	0.002	4,200.00	174.93	122.45
As 20	200.00	60.00	505.96	Bajo	1.00	1.00	41.65	0.002	0.002	0.002	4,200.00	174.93	104.96
As 21	210.00	50.00	510.29	Bajo	1.00	1.00	41.65	0.002	0.002	0.002	4,200.00	174.93	87.47
As 22	220.00	40.00	513.81	Sobre	-1.00	-1.00	41.65	0.002	0.002	0.002	4,200.00	-174.93	-69.97
As 23	230.00	30.00	516.53	Sobre	-1.00	-1.00	41.65	0.003	0.002	0.002	4,200.00	-174.93	-52.48
As 24	240.00	20.00	518.46	Sobre	-1.00	-1.00	41.65	0.003	0.002	0.002	4,200.00	-174.93	-34.99
As 25	250.00	10.00	519.62	Sobre	-1.00	-1.00	41.65	0.003	0.002	0.002	4,200.00	-174.93	-17.49
As 26	260.00	0.00	520.00	Sobre	-1.00	-1.00	41.65	0.003	0.002	0.002	4,200.00	-174.93	0.00
As 27	270.00	10.00	519.62	Sobre	-1.00	-1.00	41.65	0.003	0.002	0.002	4,200.00	-174.93	-17.49
As 28	280.00	20.00	518.46	Sobre	-1.00	-1.00	41.65	0.003	0.002	0.002	4,200.00	-174.93	-34.99
As 29	290.00	30.00	516.53	Sobre	-1.00	-1.00	41.65	0.003	0.002	0.002	4,200.00	-174.93	-52.48
As 30	300.00	40.00	513.81	Sobre	-1.00	-1.00	41.65	0.002	0.002	0.002	4,200.00	-174.93	-69.97
As 31	310.00	50.00	510.29	Sobre	-1.00	1.00	41.65	0.002	0.002	0.002	4,200.00	-174.93	87.47
As 32	320.00	60.00	505.96	Sobre	-1.00	1.00	41.65	0.002	0.002	0.002	4,200.00	-174.93	104.96
As 33	330.00	70.00	500.80	Sobre	-1.00	1.00	41.65	0.002	0.002	0.002	4,200.00	-174.93	122.45
As 34	340.00	80.00	494.77	Sobre	-1.00	1.00	41.65	0.002	0.002	0.002	3,965.97	-165.18	132.15
As 35	350.00	90.00	487.85	Sobre	-1.00	1.00	41.65	0.002	0.002	0.002	3,674.22	-153.03	137.73
As 36	360.00	100.00	480.00	Sobre	-1.00	1.00	41.65	0.002	0.002	0.002	3,382.47	-140.88	140.88
As 37	370.00	110.00	471.17	Sobre	-1.00	1.00	41.65	0.001	0.002	0.001	3,090.71	-128.73	141.60
As 38	380.00	120.00	461.30	Sobre	-1.00	1.00	41.65	0.001	0.002	0.001	2,798.96	-116.58	139.89
As 39	390.00	130.00	450.33	Sobre	-1.00	1.00	41.65	0.001	0.002	0.001	2,507.21	-104.43	135.75
As 40	400.00	140.00	438.18	Sobre	-1.00	1.00	41.65	0.001	0.002	0.001	2,215.45	-92.27	129.18
As 41	410.00	150.00	424.74	Sobre	-1.00	1.00	41.65	0.001	0.002	0.001	1,923.70	-80.12	120.18
As 42	420.00	160.00	409.88	Sobre	-1.00	1.00	41.65	0.001	0.002	0.001	1,631.95	-67.97	108.75
As 43	430.00	170.00	393.45	Sobre	-1.00	1.00	41.65	0.001	0.002	0.001	1,340.19	-55.82	94.89
As 44	440.00	180.00	375.23	Sobre	-1.00	1.00	41.65	0.000	0.002	0.000	1,048.44	-43.67	78.60
As 45	450.00	190.00	354.96	Sobre	-1.00	1.00	41.65	0.000	0.002	0.000	756.69	-31.52	59.88
As 46	460.00	200.00	332.26	Sobre	-1.00	1.00	41.65	0.000	0.002	0.000	464.94	-19.36	38.73
As 47	470.00	210.00	306.59	Sobre	-1.00	1.00	41.65	0.000	0.002	0.000	173.18	-7.21	15.15
As 48	480.00	220.00	277.13	Sobre	-1.00	1.00	41.65	0.000	0.002	0.000	118.57	-4.94	10.86
As 49	490.00	230.00	242.49	Sobre	-1.00	1.00	41.65	0.000	0.002	0.000	410.32	-17.09	39.31
As 50	500.00	240.00	200.00	Sobre	-1.00	1.00	41.65	0.000	0.002	0.000	702.08	-29.24	70.18
As 51	510.00	250.00	142.83	Sobre	-1.00	1.00	41.65	0.000	0.002	0.000	993.83	-41.39	103.48
Aportes Totales del Acero											-1,574.37	3,674.30	

Cuadro Resumen			
C =			
	Concreto	Acero	Total
P (ton)	15743.70545	-1,574.37	14,169.34
M (ton m)	26485.20154	3,674.30	30,159.50
Φ P (ton)			9210.06804
Φ M (ton m)			19603.67441

Carga y Momentos C=200 cm

Dato	Valor	Unidad
C	200	cm
a	170	cm
Angulo =	139.4955065	grados
A comp=	59515.09542	cm2

Aporte del Concreto

Carga	P (ton)	M (ton m)
Valor	14164.59271	24788.03724

Aporte del Acero

Material	di	Brazo de Palanca	b	Condicion	Signo P	Signo M	As	es o e's	ey	ε	fs	Aporte P (ton)	Aporte M (ton m)
As 1	10.00	250.00	142.83	Bajo	1.00	1.00	41.65	0.001	0.002	0.001	1,575.00	65.60	164.00
As 2	20.00	240.00	200.00	Bajo	1.00	1.00	41.65	0.001	0.002	0.001	1,260.00	52.48	125.95
As 3	30.00	230.00	242.49	Bajo	1.00	1.00	41.65	0.000	0.002	0.000	945.00	39.36	90.53
As 4	40.00	220.00	277.13	Bajo	1.00	1.00	41.65	0.000	0.002	0.000	630.00	26.24	57.73
As 5	50.00	210.00	306.59	Bajo	1.00	1.00	41.65	0.000	0.002	0.000	315.00	13.12	27.55
As 6	60.00	200.00	332.26	Bajo	1.00	1.00	41.65	0.000	0.002	0.000	0.00	0.00	0.00
As 7	70.00	190.00	354.96	Bajo	1.00	1.00	41.65	0.000	0.002	0.000	315.00	13.12	24.93
As 8	80.00	180.00	375.23	Bajo	1.00	1.00	41.65	0.000	0.002	0.000	630.00	26.24	47.23
As 9	90.00	170.00	393.45	Bajo	1.00	1.00	41.65	0.000	0.002	0.000	945.00	39.36	66.91
As 10	100.00	160.00	409.88	Bajo	1.00	1.00	41.65	0.001	0.002	0.001	1,260.00	52.48	83.97
As 11	110.00	150.00	424.74	Bajo	1.00	1.00	41.65	0.001	0.002	0.001	1,575.00	65.60	98.40
As 12	120.00	140.00	438.18	Bajo	1.00	1.00	41.65	0.001	0.002	0.001	1,890.00	78.72	110.21
As 13	130.00	130.00	450.33	Bajo	1.0								

As 33	330.00	70.00	500.80	Sobre	-1.00	1.00	41.65	0.002	0.002	0.002	4,095.00	-170.56	119.39
As 34	340.00	80.00	494.77	Sobre	-1.00	1.00	41.65	0.002	0.002	0.002	3,780.00	-157.44	125.95
As 35	350.00	90.00	487.85	Sobre	-1.00	1.00	41.65	0.002	0.002	0.002	3,465.00	-144.32	129.89
As 36	360.00	100.00	480.00	Sobre	-1.00	1.00	41.65	0.002	0.002	0.002	3,150.00	-131.20	131.20
As 37	370.00	110.00	471.17	Sobre	-1.00	1.00	41.65	0.001	0.002	0.001	2,835.00	-118.08	129.89
As 38	380.00	120.00	461.30	Sobre	-1.00	1.00	41.65	0.001	0.002	0.001	2,520.00	-104.96	125.95
As 39	390.00	130.00	450.33	Sobre	-1.00	1.00	41.65	0.001	0.002	0.001	2,205.00	-91.84	119.39
As 40	400.00	140.00	438.18	Sobre	-1.00	1.00	41.65	0.001	0.002	0.001	1,890.00	-78.72	110.21
As 41	410.00	150.00	424.74	Sobre	-1.00	1.00	41.65	0.001	0.002	0.001	1,575.00	-65.60	98.40
As 42	420.00	160.00	409.88	Sobre	-1.00	1.00	41.65	0.001	0.002	0.001	1,260.00	-52.48	83.97
As 43	430.00	170.00	393.45	Sobre	-1.00	1.00	41.65	0.000	0.002	0.000	945.00	-39.36	66.91
As 44	440.00	180.00	375.23	Sobre	-1.00	1.00	41.65	0.000	0.002	0.000	630.00	-26.24	47.23
As 45	450.00	190.00	354.96	Sobre	-1.00	1.00	41.65	0.000	0.002	0.000	315.00	-13.12	24.93
As 46	460.00	200.00	332.26	Sobre	-1.00	1.00	41.65	0.000	0.002	0.000	0.00	0.00	0.00
As 47	470.00	210.00	306.59	Sobre	-1.00	1.00	41.65	0.000	0.002	0.000	315.00	-13.12	27.55
As 48	480.00	220.00	277.13	Sobre	-1.00	1.00	41.65	0.000	0.002	0.000	630.00	-26.24	57.73
As 49	490.00	230.00	242.49	Sobre	-1.00	1.00	41.65	0.000	0.002	0.000	945.00	-39.36	90.53
As 50	500.00	240.00	200.00	Sobre	-1.00	1.00	41.65	0.001	0.002	0.001	1,260.00	-52.48	125.95
As 51	510.00	250.00	142.83	Sobre	-1.00	1.00	41.65	0.001	0.002	0.001	1,575.00	-65.60	164.00
Aportes Totales del Acero												-2,274.09	3,208.22

Cuadro Resumen			
C =			
P (ton)	14164.59271	Acero -2,274.09	Total 11,890.50
M (ton m)	24788.03724	3,208.22	27,996.25
Φ P (ton)		7728.826761	
Φ M (ton m)		18197.56474	

Carga y Momentos C=180 cm

Dato	Valor	Unidad
C	180	cm
a	153	cm
Angulo =	131.3969695	grados
A comp=	51383.7943	cm2

Aporte del Concreto

Carga	P (ton)	M (ton m)
Valor	12229.34304	22440.84448

Aporte del Acero

Material	di	Brazo de Palanca	b	Condicion	Signo P	Signo M	As	es o e's	ey	ε	fs	Aporte P (ton)	Aporte M (ton m)
As 1	10.00	250.00	142.83	Bajo	1.00	1.00	41.65	0.001	0.002	0.001	2,450.00	102.04	255.11
As 2	20.00	240.00	200.00	Bajo	1.00	1.00	41.65	0.001	0.002	0.001	2,100.00	87.47	209.92
As 3	30.00	230.00	242.49	Bajo	1.00	1.00	41.65	0.001	0.002	0.001	1,750.00	72.89	167.64
As 4	40.00	220.00	277.13	Bajo	1.00	1.00	41.65	0.001	0.002	0.001	1,400.00	58.31	128.28
As 5	50.00	210.00	306.59	Bajo	1.00	1.00	41.65	0.001	0.002	0.001	1,050.00	43.73	91.84
As 6	60.00	200.00	332.26	Bajo	1.00	1.00	41.65	0.000	0.002	0.000	700.00	29.16	58.31
As 7	70.00	190.00	354.96	Bajo	1.00	1.00	41.65	0.000	0.002	0.000	350.00	14.58	27.70
As 8	80.00	180.00	375.23	Bajo	1.00	1.00	41.65	0.000	0.002	0.000	0.00	0.00	0.00
As 9	90.00	170.00	393.45	Bajo	1.00	1.00	41.65	0.000	0.002	0.000	350.00	14.58	24.78
As 10	100.00	160.00	409.88	Bajo	1.00	1.00	41.65	0.000	0.002	0.000	700.00	29.16	46.65
As 11	110.00	150.00	424.74	Bajo	1.00	1.00	41.65	0.001	0.002	0.001	1,050.00	43.73	65.60
As 12	120.00	140.00	438.18	Bajo	1.00	1.00	41.65	0.001	0.002	0.001	1,400.00	58.31	81.63
As 13	130.00	130.00	450.33	Bajo	1.00	1.00	41.65	0.001	0.002	0.001	1,750.00	72.89	94.75
As 14	140.00	120.00	461.30	Bajo	1.00	1.00	41.65	0.001	0.002	0.001	2,100.00	87.47	104.96
As 15	150.00	110.00	471.17	Bajo	1.00	1.00	41.65	0.001	0.002	0.001	2,450.00	102.04	112.25
As 16	160.00	100.00	480.00	Bajo	1.00	1.00	41.65	0.001	0.002	0.001	2,800.00	116.62	116.62
As 17	170.00	90.00	487.85	Bajo	1.00	1.00	41.65	0.002	0.002	0.002	3,150.00	131.20	118.08
As 18	180.00	80.00	494.77	Sobre	-1.00	-1.00	41.65	0.002	0.002	0.002	3,500.00	-145.78	-116.62
As 19	190.00	70.00	500.80	Sobre	-1.00	-1.00	41.65	0.002	0.002	0.002	3,850.00	-160.35	-112.25
As 20	200.00	60.00	505.96	Sobre	-1.00	-1.00	41.65	0.002	0.002	0.002	4,200.00	-174.93	-104.96
As 21	210.00	50.00	510.29	Sobre	-1.00	-1.00	41.65	0.002	0.002	0.002	4,200.00	-174.93	-87.47
As 22	220.00	40.00	513.81	Sobre	-1.00	-1.00	41.65	0.002	0.002	0.002	4,200.00	-174.93	-69.97
As 23	230.00	30.00	516.53	Sobre	-1.00	-1.00	41.65	0.003	0.002	0.002	4,200.00	-174.93	-52.48
As 24	240.00	20.00	518.46	Sobre	-1.00	-1.00	41.65	0.003	0.002	0.002	4,200.00	-174.93	-34.99
As 25	250.00	10.00	519.62	Sobre	-1.00	-1.00	41.65	0.003	0.002	0.002	4,200.00	-174.93	-17.49
As 26	260.00	0.00	520.00	Sobre	-1.00	-1.00	41.65	0.003	0.002	0.002	4,200.00	-174.93	0.00
As 27	270.00	10.00	519.62	Sobre	-1.00	-1.00	41.65	0.003	0.002	0.002	4,200.00	-174.93	-17.49
As 28	280.00	20.00	518.46	Sobre	-1.00	-1.00	41.65	0.003	0.002	0.002	4,200.00	-174.93	-34.99
As 29	290.00	30.00	516.53	Sobre	-1.00	-1.00	41.65	0.003	0.002	0.002	4,200.00	-174.93	-52.48
As 30	300.00	40.00	513.81	Sobre	-1.00	-1.00	41.65	0.002	0.002	0.002	4,200.00	-174.93	-69.97
As 31	310.00	50.00	510.29	Sobre	-1.00	1.00	41.65	0.002	0.002	0.002	4,200.00	-174.93	87.47
As 32	320.00	60.00	505.96	Sobre	-1.00	1.00	41.65	0.002	0.002	0.002	4,200.00	-174.93	104.96
As 33	330.00	70.00	500.80	Sobre	-1.00	1.00	41.65	0.002	0.002	0.002	3,850.00	-160.35	112.25
As 34	340.00	80.00	494.77	Sobre	-1.00	1.00	41.65	0.002	0.002	0.002	3,500.00	-145.78	116.62
As 35	350.00	90.00	487.85	Sobre	-1.00	1.00	41.65	0.002	0.002	0.002	3,150.00	-131.20	118.08
As 36	360.00	100.00	480.00	Sobre	-1.00	1.00	41.65	0.001	0.002	0.001	2,800.00	-116.62	116.62
As 37	370.00	110.00	471.17	Sobre	-1.00	1.00	41.65	0.001	0.002	0.001	2,450.00	-102.04	112.25
As 38	380.00	120.00	461.30	Sobre	-1.00	1.00	41.65	0.001	0.002	0.001	2,100.00	-87.47	104.96
As 39	390.00	130.00	450.33	Sobre	-1.00	1.00	41.65	0.001	0.002	0.001	1,750.00	-72.89	94.75
As 40	400.00	140.00	438.18	Sobre	-1.00	1.00	41.65	0.001	0.002	0.001	1,400.00	-58.31	81.63
As 41	410.00	150.00	424.74	Sobre	-1.00	1.00	41.65	0.001	0.002	0.001	1,050.00	-43.73	65.60
As 42	420.00	160.00	409.88	Sobre	-1.00	1.00	41.65	0.000	0.002	0.000	700.00	-29.16	46.65
As 43	430.00	170.00	393.45	Sobre	-1.00	1.00	41.65	0.000	0.002	0.000	350.00	-14.58	24.78
As 44	440.00	180.00	375.23	Sobre	-1.00	1.00	41.65	0.000	0.002	0.000	0.00	0.00	0.00
As 45	450.00	190.00	354.96	Sobre	-1.00	1.00	41.65	0.000	0.002	0.000	350.00	-14.58	27.70
As 46	460.00	200.00	332.26	Sobre	-1.00	1.00	41.65	0.000	0.002	0.000	700.00	-29.16	58.31
As 47	470.00	210.00	306.59	Sobre	-1.00	1.00	41.65	0.001	0.002	0.001	1,050.00	-43.73	91.84
As 48	480.00	220.00	277.13	Sobre	-1.00	1.00	41.65	0.001	0.002	0.001	1,400.00	-58.31	128.28
As 49	490.00	230.00	242.49	Sobre	-1.00	1.00	41.65	0.001	0.002	0.001	1,750.00	-72.89	167.64
As 50	500.00	240.00	200.00	Sobre	-1.00	1.00	41.65	0.001	0.002	0.001	2,100.00	-87.47	209.92
As 51	510.00	250.00	142.83	Sobre	-1.00	1.00	41.65	0.001	0.002	0.001	2,450.00	-102.04	255.11
Aportes Totales del Acero												-2,886.35	3,058.36

Cuadro Resumen			
C =			
P (ton)	12229.34304	Acero -2,886.35	Total 9,343.00
M (ton m)	22440.84448	3,058.36	25,499.20
Φ P (ton)		6072.948728	
Φ M (ton m)		16574.48259	

Carga y Momentos C=160 cm

Dato	Valor	Unidad
C	160	cm
a	136	cm
Angulo =	123.0307292	grados
A comp=	43515.47367	cm2

Aporte del Concreto

Carga	P (ton)	M (ton m)
Valor	10356.68273	19884.83085

Aporte del Acero

Material	di	Brazo de Palanca	b	Condicion	Signo P	Signo M	As	es o e's	ey	ε	fs	Aporte P (ton)	Aporte M (ton m)
As 1	10.00	250.00	142.83	Bajo	1.00	1.00	41.65	0.002	0.002	0.002	3,543.75	147.60	368.99
As 2	20.00	240.00	200.00	Bajo	1.00	1.00	41.65	0.002	0.002	0.002	3,150.00	131.20	314.87
As 3	30.00	230.00	242.49	Bajo	1.00	1.00	41.65	0.001	0.002	0.001	2,756.25	114.80	264.03
As 4	40.00	220.00	277.13	Bajo	1.00	1.00	4						

As 24	240.00	20.00	518.46	Sobre	-1.00	-1.00	41.65	0.003	0.002	0.002	4,200.00	-174.93	-34.99
As 25	250.00	10.00	519.62	Sobre	-1.00	-1.00	41.65	0.003	0.002	0.002	4,200.00	-174.93	-17.49
As 26	260.00	0.00	520.00	Sobre	-1.00	-1.00	41.65	0.003	0.002	0.002	4,200.00	-174.93	0.00
As 27	270.00	10.00	519.62	Sobre	-1.00	-1.00	41.65	0.003	0.002	0.002	4,200.00	-174.93	-17.49
As 28	280.00	20.00	518.46	Sobre	-1.00	-1.00	41.65	0.003	0.002	0.002	4,200.00	-174.93	-34.99
As 29	290.00	30.00	516.53	Sobre	-1.00	-1.00	41.65	0.002	0.002	0.002	4,200.00	-174.93	-52.48
As 30	300.00	40.00	513.81	Sobre	-1.00	-1.00	41.65	0.002	0.002	0.002	4,200.00	-174.93	-69.97
As 31	310.00	50.00	510.29	Sobre	-1.00	1.00	41.65	0.002	0.002	0.002	4,200.00	-174.93	87.47
As 32	320.00	60.00	505.96	Sobre	-1.00	1.00	41.65	0.002	0.002	0.002	3,937.50	-164.00	98.40
As 33	330.00	70.00	500.80	Sobre	-1.00	1.00	41.65	0.002	0.002	0.002	3,543.75	-147.60	103.32
As 34	340.00	80.00	494.77	Sobre	-1.00	1.00	41.65	0.002	0.002	0.002	3,150.00	-131.20	104.96
As 35	350.00	90.00	487.85	Sobre	-1.00	1.00	41.65	0.001	0.002	0.001	2,756.25	-114.80	103.32
As 36	360.00	100.00	480.00	Sobre	-1.00	1.00	41.65	0.001	0.002	0.001	2,362.50	-98.40	98.40
As 37	370.00	110.00	471.17	Sobre	-1.00	1.00	41.65	0.001	0.002	0.001	1,968.75	-82.00	90.20
As 38	380.00	120.00	461.30	Sobre	-1.00	1.00	41.65	0.001	0.002	0.001	1,575.00	-65.60	78.72
As 39	390.00	130.00	450.33	Sobre	-1.00	1.00	41.65	0.001	0.002	0.001	1,181.25	-49.20	63.96
As 40	400.00	140.00	438.18	Sobre	-1.00	1.00	41.65	0.000	0.002	0.000	787.50	-32.80	45.92
As 41	410.00	150.00	424.74	Sobre	-1.00	1.00	41.65	0.000	0.002	0.000	393.75	-16.40	24.60
As 42	420.00	160.00	409.88	Sobre	-1.00	1.00	41.65	0.000	0.002	0.000	0.00	0.00	0.00
As 43	430.00	170.00	393.45	Sobre	-1.00	1.00	41.65	0.000	0.002	0.000	393.75	-16.40	27.88
As 44	440.00	180.00	375.23	Sobre	-1.00	1.00	41.65	0.000	0.002	0.000	787.50	-32.80	59.04
As 45	450.00	190.00	354.96	Sobre	-1.00	1.00	41.65	0.001	0.002	0.001	1,181.25	-49.20	93.48
As 46	460.00	200.00	332.26	Sobre	-1.00	1.00	41.65	0.001	0.002	0.001	1,575.00	-65.60	131.20
As 47	470.00	210.00	306.59	Sobre	-1.00	1.00	41.65	0.001	0.002	0.001	1,968.75	-82.00	172.20
As 48	480.00	220.00	277.13	Sobre	-1.00	1.00	41.65	0.001	0.002	0.001	2,362.50	-98.40	216.48
As 49	490.00	230.00	242.49	Sobre	-1.00	1.00	41.65	0.001	0.002	0.001	2,756.25	-114.80	264.03
As 50	500.00	240.00	200.00	Sobre	-1.00	1.00	41.65	0.002	0.002	0.002	3,150.00	-131.20	314.87
As 51	510.00	250.00	142.83	Sobre	-1.00	1.00	41.65	0.0017	0.002	0.002	3,543.75	-147.60	368.99
Aportes Totales del Acero												-3,236.21	3,553.27

Cuadro Resumen			
C =			
	Concreto	Acero	Total
P (ton)	10356.68273	-3,236.21	7,120.48
M (ton m)	19884.83085	3,553.27	23,438.10
Φ P (ton)			4628.310527
Φ M (ton m)			15234.76271

Carga y Momentos C=140 cm

Dato	Valor	Unidad
C	140	cm
a	119	cm
Angulo =	114.3182559	grados
A comp=	35963.38756	cm2

Aporte del Concreto

Carga	P (ton)	M (ton m)
Valor	8559.286239	17161.36891

Aporte del Acero

Material	di	Brazo de Palanca	b	Condicion	Signo P	Signo M	As	es o e's	ey	ε	fs	Aporte P (ton)	Aporte M (ton m)
As 1	10.00	250.00	142.83	Bajo	1.00	1.00	41.65	0.002	0.002	0.002	4,200.00	174.93	437.33
As 2	20.00	240.00	200.00	Bajo	1.00	1.00	41.65	0.002	0.002	0.002	4,200.00	174.93	419.83
As 3	30.00	230.00	242.49	Bajo	1.00	1.00	41.65	0.002	0.002	0.002	4,050.00	168.68	387.97
As 4	40.00	220.00	277.13	Bajo	1.00	1.00	41.65	0.002	0.002	0.002	3,600.00	149.94	329.87
As 5	50.00	210.00	306.59	Bajo	1.00	1.00	41.65	0.002	0.002	0.002	3,150.00	131.20	275.51
As 6	60.00	200.00	332.26	Bajo	1.00	1.00	41.65	0.001	0.002	0.001	2,700.00	112.46	224.91
As 7	70.00	190.00	354.96	Bajo	1.00	1.00	41.65	0.001	0.002	0.001	2,250.00	93.71	178.05
As 8	80.00	180.00	375.23	Bajo	1.00	1.00	41.65	0.001	0.002	0.001	1,800.00	74.97	134.95
As 9	90.00	170.00	393.45	Bajo	1.00	1.00	41.65	0.001	0.002	0.001	1,350.00	56.23	95.59
As 10	100.00	160.00	409.88	Bajo	1.00	1.00	41.65	0.000	0.002	0.000	900.00	37.49	59.98
As 11	110.00	150.00	424.74	Bajo	1.00	1.00	41.65	0.000	0.002	0.000	450.00	18.74	28.11
As 12	120.00	140.00	438.18	Bajo	1.00	1.00	41.65	0.000	0.002	0.000	0.00	0.00	0.00
As 13	130.00	130.00	450.33	Bajo	1.00	1.00	41.65	0.000	0.002	0.000	450.00	18.74	24.37
As 14	140.00	120.00	461.30	Sobre	-1.00	-1.00	41.65	0.000	0.002	0.000	900.00	-37.49	-44.98
As 15	150.00	110.00	471.17	Sobre	-1.00	-1.00	41.65	0.001	0.002	0.001	1,350.00	-56.23	-61.85
As 16	160.00	100.00	480.00	Sobre	-1.00	-1.00	41.65	0.001	0.002	0.001	1,800.00	-74.97	-74.97
As 17	170.00	90.00	487.85	Sobre	-1.00	-1.00	41.65	0.001	0.002	0.001	2,250.00	-93.71	-84.34
As 18	180.00	80.00	494.77	Sobre	-1.00	-1.00	41.65	0.001	0.002	0.001	2,700.00	-112.46	-89.96
As 19	190.00	70.00	500.80	Sobre	-1.00	-1.00	41.65	0.002	0.002	0.002	3,150.00	-131.20	-91.84
As 20	200.00	60.00	505.96	Sobre	-1.00	-1.00	41.65	0.002	0.002	0.002	3,600.00	-149.94	-89.96
As 21	210.00	50.00	510.29	Sobre	-1.00	-1.00	41.65	0.002	0.002	0.002	4,050.00	-168.68	-84.34
As 22	220.00	40.00	513.81	Sobre	-1.00	-1.00	41.65	0.002	0.002	0.002	4,200.00	-174.93	-69.97
As 23	230.00	30.00	516.53	Sobre	-1.00	-1.00	41.65	0.002	0.002	0.002	4,200.00	-174.93	-52.48
As 24	240.00	20.00	518.46	Sobre	-1.00	-1.00	41.65	0.003	0.002	0.002	4,200.00	-174.93	-34.99
As 25	250.00	10.00	519.62	Sobre	-1.00	-1.00	41.65	0.003	0.002	0.002	4,200.00	-174.93	-17.49
As 26	260.00	0.00	520.00	Sobre	-1.00	-1.00	41.65	0.003	0.002	0.002	4,200.00	-174.93	0.00
As 27	270.00	10.00	519.62	Sobre	-1.00	-1.00	41.65	0.003	0.002	0.002	4,200.00	-174.93	-17.49
As 28	280.00	20.00	518.46	Sobre	-1.00	-1.00	41.65	0.003	0.002	0.002	4,200.00	-174.93	-34.99
As 29	290.00	30.00	516.53	Sobre	-1.00	-1.00	41.65	0.002	0.002	0.002	4,200.00	-174.93	-52.48
As 30	300.00	40.00	513.81	Sobre	-1.00	-1.00	41.65	0.002	0.002	0.002	4,200.00	-174.93	-69.97
As 31	310.00	50.00	510.29	Sobre	-1.00	1.00	41.65	0.002	0.002	0.002	4,050.00	-168.68	84.34
As 32	320.00	60.00	505.96	Sobre	-1.00	1.00	41.65	0.002	0.002	0.002	3,600.00	-149.94	89.96
As 33	330.00	70.00	500.80	Sobre	-1.00	1.00	41.65	0.002	0.002	0.002	3,150.00	-131.20	91.84
As 34	340.00	80.00	494.77	Sobre	-1.00	1.00	41.65	0.001	0.002	0.001	2,700.00	-112.46	89.96
As 35	350.00	90.00	487.85	Sobre	-1.00	1.00	41.65	0.001	0.002	0.001	2,250.00	-93.71	84.34
As 36	360.00	100.00	480.00	Sobre	-1.00	1.00	41.65	0.001	0.002	0.001	1,800.00	-74.97	74.97
As 37	370.00	110.00	471.17	Sobre	-1.00	1.00	41.65	0.001	0.002	0.001	1,350.00	-56.23	61.85
As 38	380.00	120.00	461.30	Sobre	-1.00	1.00	41.65	0.000	0.002	0.000	900.00	-37.49	44.98
As 39	390.00	130.00	450.33	Sobre	-1.00	1.00	41.65	0.000	0.002	0.000	450.00	-18.74	24.37
As 40	400.00	140.00	438.18	Sobre	-1.00	1.00	41.65	0.000	0.002	0.000	0.00	0.00	0.00
As 41	410.00	150.00	424.74	Sobre	-1.00	1.00	41.65	0.000	0.002	0.000	450.00	-18.74	28.11
As 42	420.00	160.00	409.88	Sobre	-1.00	1.00	41.65	0.000	0.002	0.000	900.00	-37.49	59.98
As 43	430.00	170.00	393.45	Sobre	-1.00	1.00	41.65	0.001	0.002	0.001	1,350.00	-56.23	95.59
As 44	440.00	180.00	375.23	Sobre	-1.00	1.00	41.65	0.001	0.002	0.001	1,800.00	-74.97	134.95
As 45	450.00	190.00	354.96	Sobre	-1.00	1.00	41.65	0.001	0.002	0.001	2,250.00	-93.71	178.05
As 46	460.00	200.00	332.26	Sobre	-1.00	1.00	41.65	0.001	0.002	0.001	2,700.00	-112.46	224.91
As 47	470.00	210.00	306.59	Sobre	-1.00	1.00	41.65	0.002	0.002	0.002	3,150.00	-131.20	275.51
As 48	480.00	220.00	277.13	Sobre	-1.00	1.00	41.65	0.002	0.002	0.002	3,600.00	-149.94	329.87
As 49	490.00	230.00	242.49	Sobre	-1.00	1.00	41.65	0.002	0.002	0.002	4,050.00	-168.68	387.97
As 50	500.00	240.00	200.00	Sobre	-1.00	1.00	41.65	0.002	0.002	0.002	4,200.00	-174.93	419.83
As 51	510.00	250.00	142.83	Sobre	-1.00	1.00	41.65	0.002	0.002	0.002	4,200.00	-174.93	437.33
Aportes Totales del Acero												-3,223.71	4,843.06

As 15	150.00	110.00	471.17	Sobre	-1.00	-1.00	41.65	0.000	0.002	0.000	525.00	-21.87	-24.05
As 16	160.00	100.00	480.00	Sobre	-1.00	-1.00	41.65	0.001	0.002	0.001	1,050.00	-43.73	-43.73
As 17	170.00	90.00	487.85	Sobre	-1.00	-1.00	41.65	0.001	0.002	0.001	1,575.00	-65.60	-59.04
As 18	180.00	80.00	494.77	Sobre	-1.00	-1.00	41.65	0.001	0.002	0.001	2,100.00	-87.47	-69.97
As 19	190.00	70.00	500.80	Sobre	-1.00	-1.00	41.65	0.001	0.002	0.001	2,625.00	-109.33	-76.53
As 20	200.00	60.00	505.96	Sobre	-1.00	-1.00	41.65	0.002	0.002	0.002	3,150.00	-131.20	-78.72
As 21	210.00	50.00	510.29	Sobre	-1.00	-1.00	41.65	0.002	0.002	0.002	3,675.00	-153.06	-76.53
As 22	220.00	40.00	513.81	Sobre	-1.00	-1.00	41.65	0.002	0.002	0.002	4,200.00	-174.93	-69.97
As 23	230.00	30.00	516.53	Sobre	-1.00	-1.00	41.65	0.002	0.002	0.002	4,200.00	-174.93	-52.48
As 24	240.00	20.00	518.46	Sobre	-1.00	-1.00	41.65	0.003	0.002	0.002	4,200.00	-174.93	-34.99
As 25	250.00	10.00	519.62	Sobre	-1.00	-1.00	41.65	0.003	0.002	0.002	4,200.00	-174.93	-17.49
As 26	260.00	0.00	520.00	Sobre	-1.00	-1.00	41.65	0.003	0.002	0.002	4,200.00	-174.93	0.00
As 27	270.00	10.00	519.62	Sobre	-1.00	-1.00	41.65	0.003	0.002	0.002	4,200.00	-174.93	-17.49
As 28	280.00	20.00	518.46	Sobre	-1.00	-1.00	41.65	0.003	0.002	0.002	4,200.00	-174.93	-34.99
As 29	290.00	30.00	516.53	Sobre	-1.00	-1.00	41.65	0.002	0.002	0.002	4,200.00	-174.93	-52.48
As 30	300.00	40.00	513.81	Sobre	-1.00	-1.00	41.65	0.002	0.002	0.002	4,200.00	-174.93	-69.97
As 31	310.00	50.00	510.29	Sobre	-1.00	1.00	41.65	0.002	0.002	0.002	3,675.00	-153.06	76.53
As 32	320.00	60.00	505.96	Sobre	-1.00	1.00	41.65	0.002	0.002	0.002	3,150.00	-131.20	78.72
As 33	330.00	70.00	500.80	Sobre	-1.00	1.00	41.65	0.001	0.002	0.001	2,625.00	-109.33	76.53
As 34	340.00	80.00	494.77	Sobre	-1.00	1.00	41.65	0.001	0.002	0.001	2,100.00	-87.47	69.97
As 35	350.00	90.00	487.85	Sobre	-1.00	1.00	41.65	0.001	0.002	0.001	1,575.00	-65.60	59.04
As 36	360.00	100.00	480.00	Sobre	-1.00	1.00	41.65	0.001	0.002	0.001	1,050.00	-43.73	43.73
As 37	370.00	110.00	471.17	Sobre	-1.00	1.00	41.65	0.000	0.002	0.000	525.00	-21.87	24.05
As 38	380.00	120.00	461.30	Sobre	-1.00	1.00	41.65	0.000	0.002	0.000	0.00	0.00	0.00
As 39	390.00	130.00	450.33	Sobre	-1.00	1.00	41.65	0.000	0.002	0.000	525.00	-21.87	28.43
As 40	400.00	140.00	438.18	Sobre	-1.00	1.00	41.65	0.001	0.002	0.001	1,050.00	-43.73	61.23
As 41	410.00	150.00	424.74	Sobre	-1.00	1.00	41.65	0.001	0.002	0.001	1,575.00	-65.60	98.40
As 42	420.00	160.00	409.88	Sobre	-1.00	1.00	41.65	0.001	0.002	0.001	2,100.00	-87.47	139.94
As 43	430.00	170.00	393.45	Sobre	-1.00	1.00	41.65	0.001	0.002	0.001	2,625.00	-109.33	185.86
As 44	440.00	180.00	375.23	Sobre	-1.00	1.00	41.65	0.002	0.002	0.002	3,150.00	-131.20	236.16
As 45	450.00	190.00	354.96	Sobre	-1.00	1.00	41.65	0.002	0.002	0.002	3,675.00	-153.06	290.82
As 46	460.00	200.00	332.26	Sobre	-1.00	1.00	41.65	0.002	0.002	0.002	4,200.00	-174.93	349.86
As 47	470.00	210.00	306.59	Sobre	-1.00	1.00	41.65	0.002	0.002	0.002	4,200.00	-174.93	367.35
As 48	480.00	220.00	277.13	Sobre	-1.00	1.00	41.65	0.003	0.002	0.002	4,200.00	-174.93	384.85
As 49	490.00	230.00	242.49	Sobre	-1.00	1.00	41.65	0.003	0.002	0.002	4,200.00	-174.93	402.34
As 50	500.00	240.00	200.00	Sobre	-1.00	1.00	41.65	0.003	0.002	0.002	4,200.00	-174.93	419.83
As 51	510.00	250.00	142.83	Sobre	-1.00	1.00	41.65	0.003	0.002	0.002	4,200.00	-174.93	437.33
Aportes Totales del Acero												-2,930.08	6,275.61

Cuadro Resumen			
C =			
	Concreto	Acero	Total
P (ton)	6851.508067	-2,930.08	3,921.43
M (ton m)	14319.65186	6,275.61	20,595.27
Φ	0.754166667		
Φ P (ton)			2548.929869
Φ M (ton m)			13386.92265

Carga y Momentos C=100 cm

Dato	Valor	Unidad
C	100	cm
a	85	cm
Angulo =	95.39002059	grados
A comp=	22059.32977	cm2

Aporte del Concreto

Carga	P (ton)	M (ton m)
Valor	5250.120486	11419.01206

Aporte del Acero

Material	dí	Brazo de Palanca	b	Condicion	Signo P	Signo M	As	es o e's	ey	ε	fs	Aporte P (ton)	Aporte M (ton m)
As 1	10.00	250.00	142.83	Bajo	1.00	1.00	41.65	0.005	0.002	0.002	4,200.00	174.93	437.33
As 2	20.00	240.00	200.00	Bajo	1.00	1.00	41.65	0.004	0.002	0.002	4,200.00	174.93	419.83
As 3	30.00	230.00	242.49	Bajo	1.00	1.00	41.65	0.004	0.002	0.002	4,200.00	174.93	402.34
As 4	40.00	220.00	277.13	Bajo	1.00	1.00	41.65	0.004	0.002	0.002	4,200.00	174.93	384.85
As 5	50.00	210.00	306.59	Bajo	1.00	1.00	41.65	0.003	0.002	0.002	4,200.00	174.93	367.35
As 6	60.00	200.00	332.26	Bajo	1.00	1.00	41.65	0.003	0.002	0.002	4,200.00	174.93	349.86
As 7	70.00	190.00	354.96	Bajo	1.00	1.00	41.65	0.003	0.002	0.002	4,200.00	174.93	332.37
As 8	80.00	180.00	375.23	Bajo	1.00	1.00	41.65	0.002	0.002	0.002	4,200.00	174.93	314.87
As 9	90.00	170.00	393.45	Bajo	1.00	1.00	41.65	0.002	0.002	0.002	4,200.00	174.93	297.38
As 10	100.00	160.00	409.88	Sobre	-1.00	-1.00	41.65	0.002	0.002	0.002	3,780.00	-157.44	-251.90
As 11	110.00	150.00	424.74	Sobre	-1.00	-1.00	41.65	0.002	0.002	0.002	3,150.00	-131.20	-196.80
As 12	120.00	140.00	438.18	Sobre	-1.00	-1.00	41.65	0.001	0.002	0.001	2,520.00	-104.96	-146.94
As 13	130.00	130.00	450.33	Sobre	-1.00	-1.00	41.65	0.001	0.002	0.001	1,890.00	-78.72	-102.33
As 14	140.00	120.00	461.30	Sobre	-1.00	-1.00	41.65	0.001	0.002	0.001	1,260.00	-52.48	-62.97
As 15	150.00	110.00	471.17	Sobre	-1.00	-1.00	41.65	0.000	0.002	0.000	630.00	-26.24	-28.86
As 16	160.00	100.00	480.00	Sobre	-1.00	-1.00	41.65	0.000	0.002	0.000	0.00	0.00	0.00
As 17	170.00	90.00	487.85	Sobre	-1.00	-1.00	41.65	0.000	0.002	0.000	630.00	-26.24	-23.62
As 18	180.00	80.00	494.77	Sobre	-1.00	-1.00	41.65	0.001	0.002	0.001	1,260.00	-52.48	-41.98
As 19	190.00	70.00	500.80	Sobre	-1.00	-1.00	41.65	0.001	0.002	0.001	1,890.00	-78.72	-55.10
As 20	200.00	60.00	505.96	Sobre	-1.00	-1.00	41.65	0.001	0.002	0.001	2,520.00	-104.96	-62.97
As 21	210.00	50.00	510.29	Sobre	-1.00	-1.00	41.65	0.002	0.002	0.002	3,150.00	-131.20	-65.60
As 22	220.00	40.00	513.81	Sobre	-1.00	-1.00	41.65	0.002	0.002	0.002	3,780.00	-157.44	-62.97
As 23	230.00	30.00	516.53	Sobre	-1.00	-1.00	41.65	0.002	0.002	0.002	4,200.00	-174.93	-52.48
As 24	240.00	20.00	518.46	Sobre	-1.00	-1.00	41.65	0.002	0.002	0.002	4,200.00	-174.93	-34.99
As 25	250.00	10.00	519.62	Sobre	-1.00	-1.00	41.65	0.003	0.002	0.002	4,200.00	-174.93	-17.49
As 26	260.00	0.00	520.00	Sobre	-1.00	-1.00	41.65	0.003	0.002	0.002	4,200.00	-174.93	0.00
As 27	270.00	10.00	519.62	Sobre	-1.00	-1.00	41.65	0.003	0.002	0.002	4,200.00	-174.93	-17.49
As 28	280.00	20.00	518.46	Sobre	-1.00	-1.00	41.65	0.002	0.002	0.002	4,200.00	-174.93	-34.99
As 29	290.00	30.00	516.53	Sobre	-1.00	-1.00	41.65	0.002	0.002	0.002	4,200.00	-174.93	-52.48
As 30	300.00	40.00	513.81	Sobre	-1.00	-1.00	41.65	0.002	0.002	0.002	3,780.00	-157.44	-62.97
As 31	310.00	50.00	510.29	Sobre	-1.00	1.00	41.65	0.002	0.002	0.002	3,150.00	-131.20	65.60
As 32	320.00	60.00	505.96	Sobre	-1.00	1.00	41.65	0.001	0.002	0.001	2,520.00	-104.96	62.97
As 33	330.00	70.00	500.80	Sobre	-1.00	1.00	41.65	0.001	0.002	0.001	1,890.00	-78.72	55.10
As 34	340.00	80.00	494.77	Sobre	-1.00	1.00	41.65	0.001	0.002	0.001	1,260.00	-52.48	41.98
As 35	350.00	90.00	487.85	Sobre	-1.00	1.00	41.65	0.000	0.002	0.000	630.00	-26.24	23.62
As 36	360.00	100.00	480.00	Sobre	-1.00	1.00	41.65	0.000	0.002	0.000	0.00	0.00	0.00
As 37	370.00	110.00	471.17	Sobre	-1.00	1.00	41.65	0.000	0.002	0.000	630.00	-26.24	28.86
As 38	380.00	120.00	461.30	Sobre	-1.00	1.00	41.65	0.001	0.002	0.001	1,260.00	-52.48	62.97
As 39	390.00	130.00	450.33	Sobre	-1.00	1.00	41.65	0.001	0.002	0.001	1,890.00	-78.72	102.33
As 40	400.00	140.00	438.18	Sobre	-1.00	1.00	41.65	0.001	0.002	0.001	2,520.00	-104.96	146.94
As 41	410.00	150.00	424.74	Sobre	-1.00	1.00	41.65	0.002	0.002	0.002	3,150.00	-131.20	196.80
As 42	420.00	160.00	409.88	Sobre	-1.00	1.00	41.65	0.002	0.002	0.002	3,780.00	-157.44	251.90
As 43	430.00	170											

As 6	60.00	200.00	332.26	Bajo	1.00	1.00	41.65	0.005	0.002	0.002	4,200.00	174.93	349.86
As 7	70.00	190.00	354.96	Bajo	1.00	1.00	41.65	0.004	0.002	0.002	4,200.00	174.93	332.37
As 8	80.00	180.00	375.23	Sobre	-1.00	-1.00	41.65	0.004	0.002	0.002	4,200.00	-174.93	-314.87
As 9	90.00	170.00	393.45	Sobre	-1.00	-1.00	41.65	0.003	0.002	0.002	4,200.00	-174.93	-297.38
As 10	100.00	160.00	409.88	Sobre	-1.00	-1.00	41.65	0.003	0.002	0.002	4,200.00	-174.93	-279.89
As 11	110.00	150.00	424.74	Sobre	-1.00	-1.00	41.65	0.003	0.002	0.002	4,200.00	-174.93	-262.40
As 12	120.00	140.00	438.18	Sobre	-1.00	-1.00	41.65	0.002	0.002	0.002	4,200.00	-174.93	-244.90
As 13	130.00	130.00	450.33	Sobre	-1.00	-1.00	41.65	0.002	0.002	0.002	3,937.50	-164.00	-213.20
As 14	140.00	120.00	461.30	Sobre	-1.00	-1.00	41.65	0.002	0.002	0.002	3,150.00	-131.20	-157.44
As 15	150.00	110.00	471.17	Sobre	-1.00	-1.00	41.65	0.001	0.002	0.001	2,362.50	-98.40	-108.24
As 16	160.00	100.00	480.00	Sobre	-1.00	-1.00	41.65	0.001	0.002	0.001	1,575.00	-65.60	-65.60
As 17	170.00	90.00	487.85	Sobre	-1.00	-1.00	41.65	0.000	0.002	0.000	787.50	-32.80	-29.52
As 18	180.00	80.00	494.77	Sobre	-1.00	-1.00	41.65	0.000	0.002	0.000	0.00	0.00	0.00
As 19	190.00	70.00	500.80	Sobre	-1.00	-1.00	41.65	0.000	0.002	0.000	787.50	-32.80	-22.96
As 20	200.00	60.00	505.96	Sobre	-1.00	-1.00	41.65	0.001	0.002	0.001	1,575.00	-65.60	-39.36
As 21	210.00	50.00	510.29	Sobre	-1.00	-1.00	41.65	0.001	0.002	0.001	2,362.50	-98.40	-49.20
As 22	220.00	40.00	513.81	Sobre	-1.00	-1.00	41.65	0.002	0.002	0.002	3,150.00	-131.20	-52.48
As 23	230.00	30.00	516.53	Sobre	-1.00	-1.00	41.65	0.002	0.002	0.002	3,937.50	-164.00	-49.20
As 24	240.00	20.00	518.46	Sobre	-1.00	-1.00	41.65	0.002	0.002	0.002	4,200.00	-174.93	-34.99
As 25	250.00	10.00	519.62	Sobre	-1.00	-1.00	41.65	0.003	0.002	0.002	4,200.00	-174.93	-17.49
As 26	260.00	0.00	520.00	Sobre	-1.00	-1.00	41.65	0.003	0.002	0.002	4,200.00	-174.93	0.00
As 27	270.00	10.00	519.62	Sobre	-1.00	-1.00	41.65	0.003	0.002	0.002	4,200.00	-174.93	-17.49
As 28	280.00	20.00	518.46	Sobre	-1.00	-1.00	41.65	0.002	0.002	0.002	4,200.00	-174.93	-34.99
As 29	290.00	30.00	516.53	Sobre	-1.00	-1.00	41.65	0.002	0.002	0.002	3,937.50	-164.00	-49.20
As 30	300.00	40.00	513.81	Sobre	-1.00	-1.00	41.65	0.002	0.002	0.002	3,150.00	-131.20	-52.48
As 31	310.00	50.00	510.29	Sobre	-1.00	1.00	41.65	0.001	0.002	0.001	2,362.50	-98.40	49.20
As 32	320.00	60.00	505.96	Sobre	-1.00	1.00	41.65	0.001	0.002	0.001	1,575.00	-65.60	39.36
As 33	330.00	70.00	500.80	Sobre	-1.00	1.00	41.65	0.000	0.002	0.000	787.50	-32.80	22.96
As 34	340.00	80.00	494.77	Sobre	-1.00	1.00	41.65	0.000	0.002	0.000	0.00	0.00	0.00
As 35	350.00	90.00	487.85	Sobre	-1.00	1.00	41.65	0.000	0.002	0.000	787.50	-32.80	29.52
As 36	360.00	100.00	480.00	Sobre	-1.00	1.00	41.65	0.001	0.002	0.001	1,575.00	-65.60	65.60
As 37	370.00	110.00	471.17	Sobre	-1.00	1.00	41.65	0.001	0.002	0.001	2,362.50	-98.40	108.24
As 38	380.00	120.00	461.30	Sobre	-1.00	1.00	41.65	0.002	0.002	0.002	3,150.00	-131.20	157.44
As 39	390.00	130.00	450.33	Sobre	-1.00	1.00	41.65	0.002	0.002	0.002	3,937.50	-164.00	213.20
As 40	400.00	140.00	438.18	Sobre	-1.00	1.00	41.65	0.002	0.002	0.002	4,200.00	-174.93	244.90
As 41	410.00	150.00	424.74	Sobre	-1.00	1.00	41.65	0.003	0.002	0.002	4,200.00	-174.93	262.40
As 42	420.00	160.00	409.88	Sobre	-1.00	1.00	41.65	0.003	0.002	0.002	4,200.00	-174.93	279.89
As 43	430.00	170.00	393.45	Sobre	-1.00	1.00	41.65	0.003	0.002	0.002	4,200.00	-174.93	297.38
As 44	440.00	180.00	375.23	Sobre	-1.00	1.00	41.65	0.004	0.002	0.002	4,200.00	-174.93	314.87
As 45	450.00	190.00	354.96	Sobre	-1.00	1.00	41.65	0.004	0.002	0.002	4,200.00	-174.93	332.37
As 46	460.00	200.00	332.26	Sobre	-1.00	1.00	41.65	0.005	0.002	0.002	4,200.00	-174.93	349.86
As 47	470.00	210.00	306.59	Sobre	-1.00	1.00	41.65	0.005	0.002	0.002	4,200.00	-174.93	367.35
As 48	480.00	220.00	277.13	Sobre	-1.00	1.00	41.65	0.005	0.002	0.002	4,200.00	-174.93	384.85
As 49	490.00	230.00	242.49	Sobre	-1.00	1.00	41.65	0.006	0.002	0.002	4,200.00	-174.93	402.34
As 50	500.00	240.00	200.00	Sobre	-1.00	1.00	41.65	0.006	0.002	0.002	4,200.00	-174.93	419.83
As 51	510.00	250.00	142.83	Sobre	-1.00	1.00	41.65	0.006	0.002	0.002	4,200.00	-174.93	437.33
Aportes Totales del Acero												-4,591.91	5,079.53

Cuadro Resumen			
C =			
	Concreto	Acero	Total
P (ton)	3775.541659	-4,591.91	-816.37
M (ton m)	8532.724148	5,079.53	13,612.25
Φ P (ton)			-734.7337573
Φ M (ton m)			12251.02862

Carga y Momentos C=60 cm

Dato	Valor	Unidad
C	60	cm
a	51	cm
Angulo =	73.00206262	grados
A comp=	10311.35955	cm2

Aporte del Concreto

Carga	P (ton)	M (ton m)
Valor	2454.103574	5754.872881

Aporte del Acero

Material	di	Brazo de Palanca	b	Condicion	Signo P	Signo M	As	es o e's	ey	ε	fs	Aporte P (ton)	Aporte M (ton m)
As 1	10.00	250.00	142.83	Bajo	1.00	1.00	41.65	0.010	0.002	0.002	4,200.00	174.93	437.33
As 2	20.00	240.00	200.00	Bajo	1.00	1.00	41.65	0.009	0.002	0.002	4,200.00	174.93	419.83
As 3	30.00	230.00	242.49	Bajo	1.00	1.00	41.65	0.009	0.002	0.002	4,200.00	174.93	402.34
As 4	40.00	220.00	277.13	Bajo	1.00	1.00	41.65	0.008	0.002	0.002	4,200.00	174.93	384.85
As 5	50.00	210.00	306.59	Bajo	1.00	1.00	41.65	0.008	0.002	0.002	4,200.00	174.93	367.35
As 6	60.00	200.00	332.26	Sobre	-1.00	-1.00	41.65	0.007	0.002	0.002	4,200.00	-174.93	-349.86
As 7	70.00	190.00	354.96	Sobre	-1.00	-1.00	41.65	0.007	0.002	0.002	4,200.00	-174.93	-332.37
As 8	80.00	180.00	375.23	Sobre	-1.00	-1.00	41.65	0.006	0.002	0.002	4,200.00	-174.93	-314.87
As 9	90.00	170.00	393.45	Sobre	-1.00	-1.00	41.65	0.006	0.002	0.002	4,200.00	-174.93	-297.38
As 10	100.00	160.00	409.88	Sobre	-1.00	-1.00	41.65	0.005	0.002	0.002	4,200.00	-174.93	-279.89
As 11	110.00	150.00	424.74	Sobre	-1.00	-1.00	41.65	0.005	0.002	0.002	4,200.00	-174.93	-262.40
As 12	120.00	140.00	438.18	Sobre	-1.00	-1.00	41.65	0.004	0.002	0.002	4,200.00	-174.93	-244.90
As 13	130.00	130.00	450.33	Sobre	-1.00	-1.00	41.65	0.004	0.002	0.002	4,200.00	-174.93	-227.41
As 14	140.00	120.00	461.30	Sobre	-1.00	-1.00	41.65	0.003	0.002	0.002	4,200.00	-174.93	-209.92
As 15	150.00	110.00	471.17	Sobre	-1.00	-1.00	41.65	0.003	0.002	0.002	4,200.00	-174.93	-192.42
As 16	160.00	100.00	480.00	Sobre	-1.00	-1.00	41.65	0.002	0.002	0.002	4,200.00	-174.93	-174.93
As 17	170.00	90.00	487.85	Sobre	-1.00	-1.00	41.65	0.002	0.002	0.002	3,150.00	-131.20	-118.08
As 18	180.00	80.00	494.77	Sobre	-1.00	-1.00	41.65	0.001	0.002	0.001	2,100.00	-87.47	-69.97
As 19	190.00	70.00	500.80	Sobre	-1.00	-1.00	41.65	0.001	0.002	0.001	1,050.00	-43.73	-30.61
As 20	200.00	60.00	505.96	Sobre	-1.00	-1.00	41.65	0.000	0.002	0.000	0.00	0.00	0.00
As 21	210.00	50.00	510.29	Sobre	-1.00	-1.00	41.65	0.001	0.002	0.001	1,050.00	-43.73	-21.87
As 22	220.00	40.00	513.81	Sobre	-1.00	-1.00	41.65	0.001	0.002	0.001	2,100.00	-87.47	-34.99
As 23	230.00	30.00	516.53	Sobre	-1.00	-1.00	41.65	0.002	0.002	0.002	3,150.00	-131.20	-39.36
As 24	240.00	20.00	518.46	Sobre	-1.00	-1.00	41.65	0.002	0.002	0.002	4,200.00	-174.93	-34.99
As 25	250.00	10.00	519.62	Sobre	-1.00	-1.00	41.65	0.003	0.002	0.002	4,200.00	-174.93	-17.49
As 26	260.00	0.00	520.00	Sobre	-1.00	-1.00	41.65	0.003	0.002	0.002	4,200.00	-174.93	0.00
As 27	270.00	10.00	519.62	Sobre	-1.00	-1.00	41.65	0.003	0.002	0.002	4,200.00	-174.93	-17.49
As 28	280.00	20.00	518.46	Sobre	-1.00	-1.00	41.65	0.002	0.002	0.002	4,200.00	-174.93	-34.99
As 29	290.00	30.00	516.53	Sobre	-1.00	-1.00	41.65	0.002	0.002	0.002	3,150.00	-131.20	-39.36
As 30	300.00	40.00	513.81	Sobre	-1.00	-1.00	41.65	0.001	0.002	0.001	2,100.00	-87.47	-34.99
As 31	310.00	50.00	510.29	Sobre	-1.00	1.00	41.65	0.001	0.002	0.001	1,050.00	-43.73	21.87
As 32	320.00	60.00	505.96	Sobre	-1.00	1.00	41.65	0.000	0.002	0.000	0.00	0.00	0.00
As 33	330.00	70.00	500.80	Sobre	-1.00	1.00	41.65	0.001	0.002	0.001	1,050.00	-43.73	30.61
As 34	340.00	80.00	494.77	Sobre	-1.00	1.00							

Aporte del Acero													
Material	di	Brazo de Palanca	b	Condicion	Signo P	Signo M	As	es o e's	ey	ε	fs	Aporte P (ton)	Aporte M (ton m)
As 1	10.00	250.00	142.83	Bajo	1.00	1.00	41.65	0.016	0.002	0.002	4,200.00	174.93	437.33
As 2	20.00	240.00	200.00	Bajo	1.00	1.00	41.65	0.015	0.002	0.002	4,200.00	174.93	419.83
As 3	30.00	230.00	242.49	Bajo	1.00	1.00	41.65	0.014	0.002	0.002	4,200.00	174.93	402.34
As 4	40.00	220.00	277.13	Sobre	-1.00	-1.00	41.65	0.014	0.002	0.002	4,200.00	-174.93	-384.85
As 5	50.00	210.00	306.59	Sobre	-1.00	-1.00	41.65	0.013	0.002	0.002	4,200.00	-174.93	-367.35
As 6	60.00	200.00	332.26	Sobre	-1.00	-1.00	41.65	0.012	0.002	0.002	4,200.00	-174.93	-349.86
As 7	70.00	190.00	354.96	Sobre	-1.00	-1.00	41.65	0.011	0.002	0.002	4,200.00	-174.93	-332.37
As 8	80.00	180.00	375.23	Sobre	-1.00	-1.00	41.65	0.011	0.002	0.002	4,200.00	-174.93	-314.87
As 9	90.00	170.00	393.45	Sobre	-1.00	-1.00	41.65	0.010	0.002	0.002	4,200.00	-174.93	-297.38
As 10	100.00	160.00	409.88	Sobre	-1.00	-1.00	41.65	0.009	0.002	0.002	4,200.00	-174.93	-279.89
As 11	110.00	150.00	424.74	Sobre	-1.00	-1.00	41.65	0.008	0.002	0.002	4,200.00	-174.93	-262.40
As 12	120.00	140.00	438.18	Sobre	-1.00	-1.00	41.65	0.008	0.002	0.002	4,200.00	-174.93	-244.90
As 13	130.00	130.00	450.33	Sobre	-1.00	-1.00	41.65	0.007	0.002	0.002	4,200.00	-174.93	-227.41
As 14	140.00	120.00	461.30	Sobre	-1.00	-1.00	41.65	0.006	0.002	0.002	4,200.00	-174.93	-209.92
As 15	150.00	110.00	471.17	Sobre	-1.00	-1.00	41.65	0.005	0.002	0.002	4,200.00	-174.93	-192.42
As 16	160.00	100.00	480.00	Sobre	-1.00	-1.00	41.65	0.005	0.002	0.002	4,200.00	-174.93	-174.93
As 17	170.00	90.00	487.85	Sobre	-1.00	-1.00	41.65	0.004	0.002	0.002	4,200.00	-174.93	-157.44
As 18	180.00	80.00	494.77	Sobre	-1.00	-1.00	41.65	0.003	0.002	0.002	4,200.00	-174.93	-139.94
As 19	190.00	70.00	500.80	Sobre	-1.00	-1.00	41.65	0.002	0.002	0.002	4,200.00	-174.93	-122.45
As 20	200.00	60.00	505.96	Sobre	-1.00	-1.00	41.65	0.002	0.002	0.002	3,150.00	-131.20	-78.72
As 21	210.00	50.00	510.29	Sobre	-1.00	-1.00	41.65	0.001	0.002	0.001	1,575.00	-65.60	-32.80
As 22	220.00	40.00	513.81	Sobre	-1.00	-1.00	41.65	0.000	0.002	0.000	0.00	0.00	0.00
As 23	230.00	30.00	516.53	Sobre	-1.00	-1.00	41.65	0.001	0.002	0.001	1,575.00	-65.60	-19.68
As 24	240.00	20.00	518.46	Sobre	-1.00	-1.00	41.65	0.002	0.002	0.002	3,150.00	-131.20	-26.24
As 25	250.00	10.00	519.62	Sobre	-1.00	-1.00	41.65	0.002	0.002	0.002	4,200.00	-174.93	-17.49
As 26	260.00	0.00	520.00	Sobre	-1.00	-1.00	41.65	0.003	0.002	0.002	4,200.00	-174.93	0.00
As 27	270.00	10.00	519.62	Sobre	-1.00	-1.00	41.65	0.002	0.002	0.002	4,200.00	-174.93	-17.49
As 28	280.00	20.00	518.46	Sobre	-1.00	-1.00	41.65	0.002	0.002	0.002	3,150.00	-131.20	-26.24
As 29	290.00	30.00	516.53	Sobre	-1.00	-1.00	41.65	0.001	0.002	0.001	1,575.00	-65.60	-19.68
As 30	300.00	40.00	513.81	Sobre	-1.00	-1.00	41.65	0.000	0.002	0.000	0.00	0.00	0.00
As 31	310.00	50.00	510.29	Sobre	-1.00	1.00	41.65	0.001	0.002	0.001	1,575.00	-65.60	32.80
As 32	320.00	60.00	505.96	Sobre	-1.00	1.00	41.65	0.002	0.002	0.002	3,150.00	-131.20	78.72
As 33	330.00	70.00	500.80	Sobre	-1.00	1.00	41.65	0.002	0.002	0.002	4,200.00	-174.93	122.45
As 34	340.00	80.00	494.77	Sobre	-1.00	1.00	41.65	0.003	0.002	0.002	4,200.00	-174.93	139.94
As 35	350.00	90.00	487.85	Sobre	-1.00	1.00	41.65	0.004	0.002	0.002	4,200.00	-174.93	157.44
As 36	360.00	100.00	480.00	Sobre	-1.00	1.00	41.65	0.005	0.002	0.002	4,200.00	-174.93	174.93
As 37	370.00	110.00	471.17	Sobre	-1.00	1.00	41.65	0.005	0.002	0.002	4,200.00	-174.93	192.42
As 38	380.00	120.00	461.30	Sobre	-1.00	1.00	41.65	0.006	0.002	0.002	4,200.00	-174.93	209.92
As 39	390.00	130.00	450.33	Sobre	-1.00	1.00	41.65	0.007	0.002	0.002	4,200.00	-174.93	227.41
As 40	400.00	140.00	438.18	Sobre	-1.00	1.00	41.65	0.008	0.002	0.002	4,200.00	-174.93	244.90
As 41	410.00	150.00	424.74	Sobre	-1.00	1.00	41.65	0.008	0.002	0.002	4,200.00	-174.93	262.40
As 42	420.00	160.00	409.88	Sobre	-1.00	1.00	41.65	0.009	0.002	0.002	4,200.00	-174.93	279.89
As 43	430.00	170.00	393.45	Sobre	-1.00	1.00	41.65	0.010	0.002	0.002	4,200.00	-174.93	297.38
As 44	440.00	180.00	375.23	Sobre	-1.00	1.00	41.65	0.011	0.002	0.002	4,200.00	-174.93	314.87
As 45	450.00	190.00	354.96	Sobre	-1.00	1.00	41.65	0.011	0.002	0.002	4,200.00	-174.93	332.37
As 46	460.00	200.00	332.26	Sobre	-1.00	1.00	41.65	0.012	0.002	0.002	4,200.00	-174.93	349.86
As 47	470.00	210.00	306.59	Sobre	-1.00	1.00	41.65	0.013	0.002	0.002	4,200.00	-174.93	367.35
As 48	480.00	220.00	277.13	Sobre	-1.00	1.00	41.65	0.014	0.002	0.002	4,200.00	-174.93	384.85
As 49	490.00	230.00	242.49	Sobre	-1.00	1.00	41.65	0.014	0.002	0.002	4,200.00	-174.93	402.34
As 50	500.00	240.00	200.00	Sobre	-1.00	1.00	41.65	0.015	0.002	0.002	4,200.00	-174.93	419.83
As 51	510.00	250.00	142.83	Sobre	-1.00	1.00	41.65	0.016	0.002	0.002	4,200.00	-174.93	437.33
Aportes Totales del Acero												-6,909.74	2,392.17

Cuadro Resumen			
C =			
	Concreto	Acero	Total
P (ton)	1322.934924	-6,909.74	-5,586.80
M (ton m)	3214.731864	2,392.17	5,606.90
Φ P (ton)			-5028.120069
Φ M (ton m)			5046.209653

Carga y Momentos C=20 cm		
Dato	Valor	Unidad
C	20	cm
a	17	cm
Angulo =	41.66780748	grados
A comp=	1864.316363	cm2

Aporte del Concreto		
Carga	P (ton)	M (ton m)
Valor	443.7072944	1115.923845

Aporte del Acero													
Material	di	Brazo de Palanca	b	Condicion	Signo P	Signo M	As	es o e's	ey	ε	fs	Aporte P (ton)	Aporte M (ton m)
As 1	10.00	250.00	142.83	Bajo	1.00	1.00	41.65	0.035	0.002	0.002	4,200.00	174.93	437.33
As 2	20.00	240.00	200.00	Sobre	-1.00	-1.00	41.65	0.033	0.002	0.002	4,200.00	-174.93	-419.83
As 3	30.00	230.00	242.49	Sobre	-1.00	-1.00	41.65	0.032	0.002	0.002	4,200.00	-174.93	-402.34
As 4	40.00	220.00	277.13	Sobre	-1.00	-1.00	41.65	0.030	0.002	0.002	4,200.00	-174.93	-384.85
As 5	50.00	210.00	306.59	Sobre	-1.00	-1.00	41.65	0.029	0.002	0.002	4,200.00	-174.93	-367.35
As 6	60.00	200.00	332.26	Sobre	-1.00	-1.00	41.65	0.027	0.002	0.002	4,200.00	-174.93	-349.86
As 7	70.00	190.00	354.96	Sobre	-1.00	-1.00	41.65	0.026	0.002	0.002	4,200.00	-174.93	-332.37
As 8	80.00	180.00	375.23	Sobre	-1.00	-1.00	41.65	0.024	0.002	0.002	4,200.00	-174.93	-314.87
As 9	90.00	170.00	393.45	Sobre	-1.00	-1.00	41.65	0.023	0.002	0.002	4,200.00	-174.93	-297.38
As 10	100.00	160.00	409.88	Sobre	-1.00	-1.00	41.65	0.021	0.002	0.002	4,200.00	-174.93	-279.89
As 11	110.00	150.00	424.74	Sobre	-1.00	-1.00	41.65	0.020	0.002	0.002	4,200.00	-174.93	-262.40
As 12	120.00	140.00	438.18	Sobre	-1.00	-1.00	41.65	0.018	0.002	0.002	4,200.00	-174.93	-244.90
As 13	130.00	130.00	450.33	Sobre	-1.00	-1.00	41.65	0.017	0.002	0.002	4,200.00	-174.93	-227.41
As 14	140.00	120.00	461.30	Sobre	-1.00	-1.00	41.65	0.015	0.002	0.002	4,200.00	-174.93	-209.92
As 15	150.00	110.00	471.17	Sobre	-1.00	-1.00	41.65	0.014	0.002	0.002	4,200.00	-174.93	-192.42
As 16	160.00	100.00	480.00	Sobre	-1.00	-1.00	41.65	0.012	0.002	0.002	4,200.00	-174.93	-174.93
As 17	170.00	90.00	487.85	Sobre	-1.00	-1.00	41.65	0.011	0.002	0.002	4,200.00	-174.93	-157.44
As 18	180.00	80.00	494.77	Sobre	-1.00	-1.00	41.65	0.009	0.002	0.002	4,200.00	-174.93	-139.94
As 19	190.00	70.00	500.80	Sobre	-1.00	-1.00	41.65	0.008	0.002	0.002	4,200.00	-174.93	-122.45
As 20	200.00	60.00	505.96	Sobre	-1.00	-1.00	41.65	0.006	0.002	0.002	4,200.00	-174.93	-104.96
As 21	210.00	50.00	510.29	Sobre	-1.00	-1.00	41.65	0.005	0.002	0.002	4,200.00	-174.93	-87.47
As 22	220.00	40.00	513.81	Sobre	-1.00	-1.00	41.65	0.003	0.002	0.002	4,200.00	-174.93	-69.97
As 23	230.00	30.00	516.53	Sobre	-1.00	-1.00	41.65	0.002	0.002	0.002	3,150.00	-131.20	-39.36
As 24	240.00	20.00	518.46	Sobre	-1.00	-1.00	41.65	0.000	0.002	0.000	0.00	0.00	0.00
As 25	250.00	10.00	519.62	Sobre	-1.00	-1.00	41.65	0.002	0.002	0.002	3,150.00	-131.20	-13.12
As 26	260.00	0.00	520.00	Sobre	-1.00	-1.00	41.65	0.003	0.002	0.002	4,200.00	-174.93	0.00
As 27	270.00	10.00	519.62	Sobre	-1.00	-1.00	41.65	0.002					

C	10	cm
a	8.5	cm
Angulo =	29.38195876	grados
A comp=	576.4387041	cm2

Aporte del Concreto

Carga	P (ton)	M (ton m)
Valor	137.1924116	350.8695926

Aporte del Acero

Material	di	Brazo de Palanca	b	Condicion	Signo P	Signo M	As	es o e's	ey	ε	fs	Aporte P (ton)	Aporte M (ton m)
As 1	10.00	250.00	142.83	Sobre	-1.00	-1.00	41.65	0.072	0.002	0.002	4,200.00	-174.93	-437.33
As 2	20.00	240.00	200.00	Sobre	-1.00	-1.00	41.65	0.069	0.002	0.002	4,200.00	-174.93	-419.83
As 3	30.00	230.00	242.49	Sobre	-1.00	-1.00	41.65	0.066	0.002	0.002	4,200.00	-174.93	-402.34
As 4	40.00	220.00	277.13	Sobre	-1.00	-1.00	41.65	0.063	0.002	0.002	4,200.00	-174.93	-384.85
As 5	50.00	210.00	306.59	Sobre	-1.00	-1.00	41.65	0.060	0.002	0.002	4,200.00	-174.93	-367.35
As 6	60.00	200.00	332.26	Sobre	-1.00	-1.00	41.65	0.057	0.002	0.002	4,200.00	-174.93	-349.86
As 7	70.00	190.00	354.96	Sobre	-1.00	-1.00	41.65	0.054	0.002	0.002	4,200.00	-174.93	-332.37
As 8	80.00	180.00	375.23	Sobre	-1.00	-1.00	41.65	0.051	0.002	0.002	4,200.00	-174.93	-314.87
As 9	90.00	170.00	393.45	Sobre	-1.00	-1.00	41.65	0.048	0.002	0.002	4,200.00	-174.93	-297.38
As 10	100.00	160.00	409.88	Sobre	-1.00	-1.00	41.65	0.045	0.002	0.002	4,200.00	-174.93	-279.89
As 11	110.00	150.00	424.74	Sobre	-1.00	-1.00	41.65	0.042	0.002	0.002	4,200.00	-174.93	-262.40
As 12	120.00	140.00	438.18	Sobre	-1.00	-1.00	41.65	0.039	0.002	0.002	4,200.00	-174.93	-244.90
As 13	130.00	130.00	450.33	Sobre	-1.00	-1.00	41.65	0.036	0.002	0.002	4,200.00	-174.93	-227.41
As 14	140.00	120.00	461.30	Sobre	-1.00	-1.00	41.65	0.033	0.002	0.002	4,200.00	-174.93	-209.92
As 15	150.00	110.00	471.17	Sobre	-1.00	-1.00	41.65	0.030	0.002	0.002	4,200.00	-174.93	-192.42
As 16	160.00	100.00	480.00	Sobre	-1.00	-1.00	41.65	0.027	0.002	0.002	4,200.00	-174.93	-174.93
As 17	170.00	90.00	487.85	Sobre	-1.00	-1.00	41.65	0.024	0.002	0.002	4,200.00	-174.93	-157.44
As 18	180.00	80.00	494.77	Sobre	-1.00	-1.00	41.65	0.021	0.002	0.002	4,200.00	-174.93	-139.94
As 19	190.00	70.00	500.80	Sobre	-1.00	-1.00	41.65	0.018	0.002	0.002	4,200.00	-174.93	-122.45
As 20	200.00	60.00	505.96	Sobre	-1.00	-1.00	41.65	0.015	0.002	0.002	4,200.00	-174.93	-104.96
As 21	210.00	50.00	510.29	Sobre	-1.00	-1.00	41.65	0.012	0.002	0.002	4,200.00	-174.93	-87.47
As 22	220.00	40.00	513.81	Sobre	-1.00	-1.00	41.65	0.009	0.002	0.002	4,200.00	-174.93	-69.97
As 23	230.00	30.00	516.53	Sobre	-1.00	-1.00	41.65	0.006	0.002	0.002	4,200.00	-174.93	-52.48
As 24	240.00	20.00	518.46	Sobre	-1.00	-1.00	41.65	0.003	0.002	0.002	4,200.00	-174.93	-34.99
As 25	250.00	10.00	519.62	Sobre	-1.00	-1.00	41.65	0.000	0.002	0.000	0.00	0.00	0.00
As 26	260.00	0.00	520.00	Sobre	-1.00	-1.00	41.65	0.003	0.002	0.002	4,200.00	-174.93	0.00
As 27	270.00	10.00	519.62	Sobre	-1.00	-1.00	41.65	0.000	0.002	0.000	0.00	0.00	0.00
As 28	280.00	20.00	518.46	Sobre	-1.00	-1.00	41.65	0.003	0.002	0.002	4,200.00	-174.93	-34.99
As 29	290.00	30.00	516.53	Sobre	-1.00	-1.00	41.65	0.006	0.002	0.002	4,200.00	-174.93	-52.48
As 30	300.00	40.00	513.81	Sobre	-1.00	-1.00	41.65	0.009	0.002	0.002	4,200.00	-174.93	-69.97
As 31	310.00	50.00	510.29	Sobre	-1.00	1.00	41.65	0.012	0.002	0.002	4,200.00	-174.93	87.47
As 32	320.00	60.00	505.96	Sobre	-1.00	1.00	41.65	0.015	0.002	0.002	4,200.00	-174.93	104.96
As 33	330.00	70.00	500.80	Sobre	-1.00	1.00	41.65	0.018	0.002	0.002	4,200.00	-174.93	122.45
As 34	340.00	80.00	494.77	Sobre	-1.00	1.00	41.65	0.021	0.002	0.002	4,200.00	-174.93	139.94
As 35	350.00	90.00	487.85	Sobre	-1.00	1.00	41.65	0.024	0.002	0.002	4,200.00	-174.93	157.44
As 36	360.00	100.00	480.00	Sobre	-1.00	1.00	41.65	0.027	0.002	0.002	4,200.00	-174.93	174.93
As 37	370.00	110.00	471.17	Sobre	-1.00	1.00	41.65	0.030	0.002	0.002	4,200.00	-174.93	192.42
As 38	380.00	120.00	461.30	Sobre	-1.00	1.00	41.65	0.033	0.002	0.002	4,200.00	-174.93	209.92
As 39	390.00	130.00	450.33	Sobre	-1.00	1.00	41.65	0.036	0.002	0.002	4,200.00	-174.93	227.41
As 40	400.00	140.00	438.18	Sobre	-1.00	1.00	41.65	0.039	0.002	0.002	4,200.00	-174.93	244.90
As 41	410.00	150.00	424.74	Sobre	-1.00	1.00	41.65	0.042	0.002	0.002	4,200.00	-174.93	262.40
As 42	420.00	160.00	409.88	Sobre	-1.00	1.00	41.65	0.045	0.002	0.002	4,200.00	-174.93	279.89
As 43	430.00	170.00	393.45	Sobre	-1.00	1.00	41.65	0.048	0.002	0.002	4,200.00	-174.93	297.38
As 44	440.00	180.00	375.23	Sobre	-1.00	1.00	41.65	0.051	0.002	0.002	4,200.00	-174.93	314.87
As 45	450.00	190.00	354.96	Sobre	-1.00	1.00	41.65	0.054	0.002	0.002	4,200.00	-174.93	332.37
As 46	460.00	200.00	332.26	Sobre	-1.00	1.00	41.65	0.057	0.002	0.002	4,200.00	-174.93	349.86
As 47	470.00	210.00	306.59	Sobre	-1.00	1.00	41.65	0.060	0.002	0.002	4,200.00	-174.93	367.35
As 48	480.00	220.00	277.13	Sobre	-1.00	1.00	41.65	0.063	0.002	0.002	4,200.00	-174.93	384.85
As 49	490.00	230.00	242.49	Sobre	-1.00	1.00	41.65	0.066	0.002	0.002	4,200.00	-174.93	402.34
As 50	500.00	240.00	200.00	Sobre	-1.00	1.00	41.65	0.069	0.002	0.002	4,200.00	-174.93	419.83
As 51	510.00	250.00	142.83	Sobre	-1.00	1.00	41.65	0.072	0.002	0.002	4,200.00	-174.93	437.33
Aportes Totales del Acero												-8,571.57	-314.87

Cuadro Resumen			
C =			
	Concreto	Acero	Total
P (ton)	137.1924116	-8,571.57	-8,434.38
M (ton m)	350.8695926	-314.87	36.00
Φ P (ton)			-5482.345432
Φ M (ton m)			32.39603334

Información Previa		
Dato	Valor	Unidad
Pila	2	-
Fc'	280	kg/cm2
β1	0.85	-
ec	0.003	-
Fy	4200	kg/cm2
Es	2100000	kg/cm2
Ey	0.002	-
Recubrimiento	5	cm
b	150	cm
h	520	cm
Ag	78000.00	cm2
As min	780.00	cm2
Ast	780.00	cm2
Ac	77220.00	cm2
Peralte Efectivo d	515	cm
Cent Plast hcp	75	cm

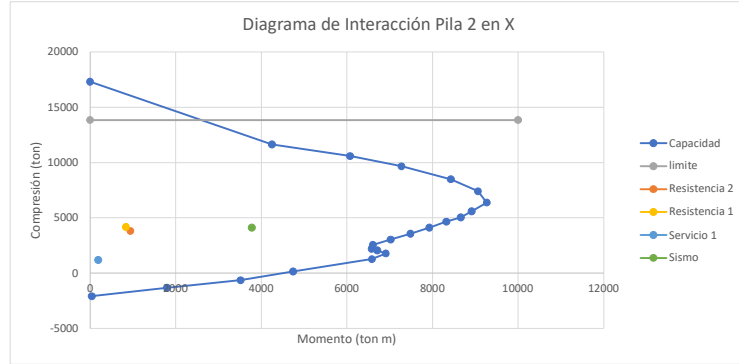

Cuadro Resumen		
C (cm)	P (ton)	M (ton m)
Compresión Pura		
-	17323.488	0
Sobre Cb		
515	11648.15116	4250.882573
475	10600.16533	6071.599614
435	9671.217678	7276.08787
390	8499.9642	8429.678953
350	7417.3554	9063.964378
Balanceado		
309	6398.96985	9269.428542
Bajo Cb		
280	5596.1997	8915.26826
260	5,054.90	8662.912526
240	4660.4103	8321.488041
220	4119.1059	7924.838458
200	3577.8015	7484.287774
180	3049.451753	7022.6702
160	2575.079726	6606.08391
140	2213.289803	6578.058538
120	2074.679007	6708.115352
100	1786.23658	6906.964832
80	1279.010806	6583.477579
60	167.7786353	4743.184857
40	-635.5314	3518.5563
20	-1310.291418	1798.979546
10	-2079.9072	39.9061215

Compresión Pura

Dato	Valor	Unidad
Po	21654.36	ton
Pcu	17323.488	ton
Pn max	14075.334	ton
Pcu Max	11260.2672	ton

Dato	Valor	Unidad
Mo	0	ton m
Mcu	0	ton m
Mo Max	0	ton m
Mcu max	0	ton m

Falla Balanceada

Carga y Momentos Balanceados

Dato	Valor	Unidad
C	309	cm
a	262.65	cm
Area Comprimida	39397.5	cm2

Aporte del Concreto

Carga	P (ton)	M (ton m)
Valor	9376.605	12065.34648

Aporte del Acero

Material	di	Brazo de Palanca	b	Condicion	Signo P	Signo M	As	es o e's	ey	ε	fs	Aporte P (ton)	Aporte M (ton m)
As 1	10.00	250.00	150.00	Bajo	1.00	1.00	37.14	0.001	0.002	0.001	1,502.74	55.81	139.53
As 2	35.00	225.00	150.00	Bajo	1.00	1.00	37.14	0.001	0.002	0.001	1,982.47	73.63	165.66
As 3	60.00	200.00	150.00	Bajo	1.00	1.00	37.14	0.001	0.002	0.001	2,462.19	91.45	182.89
As 4	85.00	175.00	150.00	Bajo	1.00	1.00	37.14	0.001	0.002	0.001	2,941.92	109.26	191.21
As 5	110.00	150.00	150.00	Bajo	1.00	1.00	37.14	0.002	0.002	0.002	3,421.64	127.08	190.62
As 6	135.00	125.00	150.00	Bajo	1.00	1.00	37.14	0.002	0.002	0.002	3,901.37	144.90	181.12
As 7	160.00	100.00	150.00	Bajo	1.00	1.00	37.14	0.002	0.002	0.002	4,200.00	155.99	155.99
As 8	185.00	75.00	150.00	Bajo	1.00	1.00	37.14	0.002	0.002	0.002	4,200.00	155.99	116.99
As 9	210.00	50.00	150.00	Bajo	1.00	1.00	37.14	0.003	0.002	0.002	4,200.00	155.99	77.99
As 10	235.00	25.00	150.00	Bajo	1.00	1.00	37.14	0.003	0.002	0.002	4,200.00	155.99	39.00
As 11	260.00	0.00	150.00	Bajo	1.00	1.00	37.14	0.003	0.002	0.002	4,200.00	155.99	0.00
As 12	285.00	-25.00	150.00	Bajo	1.00	1.00	37.14	0.003	0.002	0.002	4,200.00	155.99	-39.00
As 13	310.00	-50.00	150.00	Sobre	-1.00	1.00	37.14	0.003	0.002	0.002	4,200.00	-155.99	-77.99
As 14	335.00	75.00	150.00	Sobre	-1.00	1.00	37.14	0.002	0.002	0.002	4,200.00	-155.99	116.99
As 15	360.00	100.00	150.00	Sobre	-1.00	1.00	37.14	0.002	0.002	0.002	4,200.00	-155.99	155.99
As 16	385.00	125.00	150.00	Sobre	-1.00	1.00	37.14	0.002	0.002	0.002	3,901.37	-144.90	181.12
As 17	410.00	150.00	150.00	Sobre	-1.00	1.00	37.14	0.002	0.002	0.002	3,421.64	-127.08	190.62
As 18	435.00	175.00	150.00	Sobre	-1.00	1.00	37.14	0.001	0.002	0.001	2,941.92	-109.26	191.21
As 19	460.00	200.00	150.00	Sobre	-1.00	1.00	37.14	0.001	0.002	0.001	2,462.19	-91.45	182.89
As 20	485.00	225.00	150.00	Sobre	-1.00	1.00	37.14	0.001	0.002	0.001	1,982.47	-73.63	165.66
As 21	510.00	250.00	150.00	Sobre	-1.00	1.00	37.14	0.001	0.002	0.001	1,502.74	-55.81	139.53
Aportes Totales del Acero												467.96	2,648.03

Cuadro Resumen			
C =			
	Concreto	Acero	Total
P (ton)	9376.605	467.96	9,844.57
M (ton m)	12065.34648	2,648.03	14,713.38
Φ P (ton)			6398.96985
Φ M (ton m)			9269.428542

Valores Sobre el Cb

Carga y Momentos Cb=350

Dato	Valor	Unidad
C	350	cm
a	297.5	cm
Area Comprimida	44625	cm2

Aporte del Concreto

Carga	P (ton)	M (ton m)
Valor	10620.75	11815.58438

Aporte del Acero

Material	di	Brazo de Palanca	b	Condicion	Signo P	Signo M	As	es o e's	ey	ε	fs	Aporte P (ton)	Aporte M (ton m)
As 1	10.00	250.00	150.00	Bajo	1.00	1.00	26.89	0.001	0.002	0.001	2,064.71	55.52	138.80
As 2	35.00	225.00	150.00	Bajo	1.00	1.00	26.89	0.001	0.002	0.001	2,488.24	66.91	150.54
As 3	60.00	200.00	150.00	Bajo	1.00	1.00	26.89	0.001	0.002	0.001	2,911.76	78.30	156.59
As 4	85.00	175.00	150.00	Bajo	1.00	1.00	26.89	0.002	0.002	0.002	3,335.29	89.69	156.95
As 5	110.00	150.00	150.00	Bajo	1.00	1.00	26.89	0.002	0.002	0.002	3,758.82	101.07	151.61
As 6	135.00	125.00	150.00	Bajo	1.00	1.00	26.89	0.002	0.002	0.002	4,182.35	112.46	140.58
As 7	160.00	100.00	150.00	Bajo	1.00	1.00	26.89	0.002	0.002	0.002	4,200.00	112.94	112.94
As 8	185.00	75.00	150.00	Bajo	1.00	1.00	26.89	0.002	0.002	0.002	4,200.00	112.94	84.70
As 9	210.00	50.00	150.00	Bajo	1.00	1.00	26.89	0.003	0.002	0.002	4,200.00	112.94	56.47
As 10	235.00	25.00	150.00	Bajo	1.00	1.00	26.89	0.003	0.002	0.002	4,200.00	112.94	28.23
As 11	260.00	0.00	150.00	Bajo	1.00	1.00	26.89	0.003	0.002	0.002	4,200.00	112.94	0.00
As 12	285.00	-25.00	150.00	Bajo	1.00	1.00	26.89	0.003	0.002	0.002	4,200.00	112.94	-28.23
As 13	310.00	-50.00	150.00	Bajo	1.00	-1.00	26.89	0.003	0.002	0.002	4,200.00	112.94	56.47
As 14	335.00	75.00	150.00	Bajo	1.00	-1.00	26.89	0.002	0.002	0.002	4,200.00	112.94	-84.70
As 15	360.00	100.00	150.00	Sobre	-1.00	1.00	26.89	0.002	0.002	0.002	4,200.00	-112.94	112.94
As 16	385.00	125.00	150.00	Sobre	-1.00	1.00	26.89	0.002	0.002	0.002	4,182.35	-112.46	140.58
As 17	410.00	150.00	150.00	Sobre	-1.00	1.00	26.89	0.002	0.002	0.002	3,758.82	-101.07	151.61
As 18	435.00	175.00	150.00	Sobre	-1.00	1.00	26.89	0.002	0.002	0.002	3,335.29	-89.69	156.95
As 19	460.00	200.00	150.00	Sobre	-1.00	1.00	26.89	0.001	0.002	0.001	2,911.76	-78.30	156.59
As 20	485.00	225.00	150.00	Sobre	-1.00	1.00	26.89	0.001	0.002	0.001	2,488.24	-66.91	150.54
As 21	510.00	250.00	150.00	Sobre	-1.00	1.00	26.89	0.001	0.002	0.001	2,064.71	-55.52	138.80
Aportes Totales del Acero												790.57	2,128.98

Cuadro Resumen			
C =			
	Concreto	Acero	Total
P (ton)	10620.75	790.57	11,411.32
M (ton m)	11815.58438	2,128.98	13,944.56
Φ P (ton)			7417.3554
Φ M (ton m)			9063.964378

Carga y Momentos C=390 cm

Dato	Valor	Unidad
C	390	cm

a	331.5	cm
Area Comprimida	49725	cm2

Aporte del Concreto

Carga	P (ton)	M (ton m)
Valor	11834.55	11154.06338

Aporte del Acero

Material	di	Brazo de Palanca	b	Condicion	Signo P	Signo M	As	es o e's	ey	ε	fs	Aporte P (ton)	Aporte M (ton m)
As 1	10.00	250.00	150.00	Bajo	1.00	1.00	26.89	0.001	0.002	0.001	2,499.10	67.20	168.00
As 2	35.00	225.00	150.00	Bajo	1.00	1.00	26.89	0.001	0.002	0.001	2,879.19	77.42	174.20
As 3	60.00	200.00	150.00	Bajo	1.00	1.00	26.89	0.002	0.002	0.002	3,259.28	87.64	175.28
As 4	85.00	175.00	150.00	Bajo	1.00	1.00	26.89	0.002	0.002	0.002	3,639.37	97.86	171.26
As 5	110.00	150.00	150.00	Bajo	1.00	1.00	26.89	0.002	0.002	0.002	4,019.46	108.08	162.12
As 6	135.00	125.00	150.00	Bajo	1.00	1.00	26.89	0.002	0.002	0.002	4,200.00	112.94	141.17
As 7	160.00	100.00	150.00	Bajo	1.00	1.00	26.89	0.002	0.002	0.002	4,200.00	112.94	112.94
As 8	185.00	75.00	150.00	Bajo	1.00	1.00	26.89	0.002	0.002	0.002	4,200.00	112.94	84.70
As 9	210.00	50.00	150.00	Bajo	1.00	1.00	26.89	0.003	0.002	0.002	4,200.00	112.94	56.47
As 10	235.00	25.00	150.00	Bajo	1.00	1.00	26.89	0.003	0.002	0.002	4,200.00	112.94	28.23
As 11	260.00	0.00	150.00	Bajo	1.00	1.00	26.89	0.003	0.002	0.002	4,200.00	112.94	0.00
As 12	285.00	-25.00	150.00	Bajo	1.00	1.00	26.89	0.003	0.002	0.002	4,200.00	112.94	-28.23
As 13	310.00	-50.00	150.00	Bajo	1.00	-1.00	26.89	0.003	0.002	0.002	4,200.00	112.94	56.47
As 14	335.00	75.00	150.00	Bajo	1.00	-1.00	26.89	0.002	0.002	0.002	4,200.00	112.94	-84.70
As 15	360.00	100.00	150.00	Bajo	1.00	-1.00	26.89	0.002	0.002	0.002	4,200.00	112.94	-112.94
As 16	385.00	125.00	150.00	Bajo	1.00	-1.00	26.89	0.002	0.002	0.002	4,200.00	112.94	-141.17
As 17	410.00	150.00	150.00	Sobre	-1.00	1.00	26.89	0.002	0.002	0.002	4,019.46	-108.08	162.12
As 18	435.00	175.00	150.00	Sobre	-1.00	1.00	26.89	0.002	0.002	0.002	3,639.37	-97.86	171.26
As 19	460.00	200.00	150.00	Sobre	-1.00	1.00	26.89	0.002	0.002	0.002	3,259.28	-87.64	175.28
As 20	485.00	225.00	150.00	Sobre	-1.00	1.00	26.89	0.001	0.002	0.001	2,879.19	-77.42	174.20
As 21	510.00	250.00	150.00	Sobre	-1.00	1.00	26.89	0.001	0.002	0.001	2,499.10	-67.20	168.00
Aportes Totales del Acero												1,242.32	1,814.67

Cuadro Resumen			
C =			
	Concreto	Acero	Total
P (ton)	11834.55	1,242.32	13,076.87
M (ton m)	11154.06338	1,814.67	12,968.74
Φ P (ton)			8499.9642
Φ M (ton m)			8429.678953

Carga y Momentos C=435 cm

Dato	Valor	Unidad
C	435	cm
a	369.75	cm
Area Comprimida	55462.5	cm2

Aporte del Concreto

Carga	P (ton)	M (ton m)
Valor	13200.075	9916.556344

Aporte del Acero

Material	di	Brazo de Palanca	b	Condicion	Signo P	Signo M	As	es o e's	ey	ε	fs	Aporte P (ton)	Aporte M (ton m)
As 1	10.00	250.00	150.00	Bajo	1.00	1.00	26.89	0.001	0.002	0.001	2,892.29	77.77	194.43
As 2	35.00	225.00	150.00	Bajo	1.00	1.00	26.89	0.002	0.002	0.002	3,233.06	86.94	195.61
As 3	60.00	200.00	150.00	Bajo	1.00	1.00	26.89	0.002	0.002	0.002	3,573.83	96.10	192.20
As 4	85.00	175.00	150.00	Bajo	1.00	1.00	26.89	0.002	0.002	0.002	3,914.60	105.26	184.21
As 5	110.00	150.00	150.00	Bajo	1.00	1.00	26.89	0.002	0.002	0.002	4,200.00	112.94	169.41
As 6	135.00	125.00	150.00	Bajo	1.00	1.00	26.89	0.002	0.002	0.002	4,200.00	112.94	141.17
As 7	160.00	100.00	150.00	Bajo	1.00	1.00	26.89	0.002	0.002	0.002	4,200.00	112.94	112.94
As 8	185.00	75.00	150.00	Bajo	1.00	1.00	26.89	0.003	0.002	0.002	4,200.00	112.94	84.70
As 9	210.00	50.00	150.00	Bajo	1.00	1.00	26.89	0.003	0.002	0.002	4,200.00	112.94	56.47
As 10	235.00	25.00	150.00	Bajo	1.00	1.00	26.89	0.003	0.002	0.002	4,200.00	112.94	28.23
As 11	260.00	0.00	150.00	Bajo	1.00	1.00	26.89	0.003	0.002	0.002	4,200.00	112.94	0.00
As 12	285.00	-25.00	150.00	Bajo	1.00	1.00	26.89	0.003	0.002	0.002	4,200.00	112.94	-28.23
As 13	310.00	-50.00	150.00	Bajo	1.00	-1.00	26.89	0.003	0.002	0.002	4,200.00	112.94	56.47
As 14	335.00	75.00	150.00	Bajo	1.00	-1.00	26.89	0.003	0.002	0.002	4,200.00	112.94	-84.70
As 15	360.00	100.00	150.00	Bajo	1.00	-1.00	26.89	0.002	0.002	0.002	4,200.00	112.94	-112.94
As 16	385.00	125.00	150.00	Bajo	1.00	-1.00	26.89	0.002	0.002	0.002	4,200.00	112.94	-141.17
As 17	410.00	150.00	150.00	Bajo	1.00	-1.00	26.89	0.002	0.002	0.002	4,200.00	112.94	-169.41
As 18	435.00	175.00	150.00	Bajo	1.00	-1.00	26.89	0.002	0.002	0.002	3,914.60	105.26	-184.21
As 19	460.00	200.00	150.00	Sobre	-1.00	1.00	26.89	0.002	0.002	0.002	3,573.83	-96.10	192.20
As 20	485.00	225.00	150.00	Sobre	-1.00	1.00	26.89	0.002	0.002	0.002	3,233.06	-86.94	195.61
As 21	510.00	250.00	150.00	Sobre	-1.00	1.00	26.89	0.001	0.002	0.001	2,892.29	-77.77	194.43
Aportes Totales del Acero												1,678.72	1,277.42

Cuadro Resumen			
C =			
	Concreto	Acero	Total
P (ton)	13200.075	1,678.72	14,878.80
M (ton m)	9916.556344	1,277.42	11,193.98
Φ P (ton)			9671.217678
Φ M (ton m)			7276.08787

Carga y Momentos C=475 cm

Dato	Valor	Unidad
C	475	cm
a	403.75	cm
Area Comprimida	60562.5	cm2

Aporte del Concreto

Carga	P (ton)	M (ton m)
Valor	14413.875	8378.064844

Aporte del Acero

Material	di	Brazo de Palanca	b	Condicion	Signo P	Signo M	As	es o e's	ey	ε	fs	Aporte P (ton)	Aporte M (ton m)
As 1	10.00	250.00	150.00	Bajo	1.00	1.00	26.89	0.002	0.002	0.002	3,179.26	85.49	213.73
As 2	35.00	225.00	150.00	Bajo	1.00	1.00	26.89	0.002	0.002	0.002	3,491.33	93.88	211.23
As 3	60.00	200.00	150.00	Bajo	1.00	1.00	26.89	0.002	0.002	0.002	3,803.41	102.27	204.55
As 4	85.00	175.00	150.00	Bajo	1.00	1.00	26.89	0.002	0.002	0.002	4,115.48	110.67	193.66
As 5	110.00	150.00	150.00	Bajo	1.00	1.00	26.89	0.002	0.002	0.002	4,200.00	112.94	169.41
As 6	135.00	125.00	150.00	Bajo	1.00	1.00	26.89	0.002	0.002	0.002	4,200.00	112.94	141.17
As 7	160.00	100.00	150.00	Bajo	1.00	1.00	26.89	0.002	0.002	0.002	4,200.00	112.94	112.94
As 8	185.00	75.00	150.00	Bajo	1.00	1.00	26.89	0.003	0.002	0.002	4,200.00	112.94	84.70
As 9	210.00	50.00	150.00	Bajo	1.00	1.00	26.89	0.003	0.002	0.002	4,200.00	112.94	56.47
As 10	235.00	25.00	150.00	Bajo	1.00	1.00	26.89	0.003	0.002	0.002	4,200.00	112.94	28.23
As 11	260.00	0.00	150.00	Bajo	1.00	1.00	26.89	0.003	0.002	0.002	4,200.00	112.94	0.00
As 12	285.00	-25.00	150.00	Bajo	1.00	1.00	26.89	0.003	0.002	0.002	4,200.00	112.94	-28.23
As 13	310.00	-50.00	150.00	Bajo	1.00	-1.00	26.89	0.003	0.002	0.002	4,200.00	112.94	56.47
As 14	335.00	75.00	150.00	Bajo	1.00	-1.00	26.89	0.003	0.002	0.002	4,200.00	112.94	-84.70
As 15	360.00	100.00	150.00	Bajo	1.00	-1.00	26.89	0.002	0.002	0.002	4,200.00	112.94	-112.94
As 16	385.00	125.00	150.00	Bajo	1.00	-1.00	26.89	0.002	0.002	0.002	4,200.00	112.94	-141.17
As 17	410.00	150.00	150.00	Bajo	1.00	-1.00	26.89	0.002	0.002	0.002	4,200.00	112.94	-169.41
As 18	435.00	175.00	150.00	Bajo	1.00	-1.00	26.89	0.002	0.002	0.002	4,115.48	110.67	-193.66
As 19	460.00	200.00	150.00	Bajo	1.00	-1.00	26.89	0.002	0.002	0.002	3,803.41	102.27	-204.55
As 20	485.00	225.00	150.00	Sobre	-1.00	1.00	26.89	0.002	0.002	0.002	3,491.33	-93.88	211.23
As 21	510.00	250.00	150.00	Sobre	-1.00	1.00	26.89	0.002	0.002	0.002	3,179.26	-85.49	213.73
Aportes Totales del Acero												1,894.07	962.86

Cuadro Resumen			
C =			
	Concreto	Acero	Total
P (ton)	14413.875	1,894.07	16,307.95
M (ton m)	8378.064844	962.86	9,340.92
Φ P (ton)			10600.16533
Φ M (ton m)			6071.599614

Carga y Momentos C=515 cm

Dato	Valor	Unidad
C	515	cm
a	437.75	cm
Area Comprimida	65662.5	cm2

Aporte del Concreto

Carga	P (ton)	M (ton m)
Valor	15627.675	6426.881344

Aporte del Acero

Material	di	Brazo de Palanca	b	Condicion	Signo P	Signo M	As	es o e's	ey	ε	fs	Aporte P (ton)	Aporte M (ton m)
As 1	10.00	250.00	150.00	Bajo	1.00	1.00	26.89	0.002	0.002	0.002	3,421.64	92.01	230.02
As 2	35.00	225.00	150.00	Bajo	1.00	1.00	26.89	0.002	0.002	0.002	3,709.48	99.75	224.43
As 3	60.00	200.00	150.00	Bajo	1.00	1.00	26.89	0.002	0.002	0.002	3,997.32	107.49	214.98
As 4	85.00	175.00	150.00	Bajo	1.00	1.00	26.89	0.002	0.002	0.002	4,200.00	112.94	197.64
As 5	110.00	150.00	150.00	Bajo	1.00	1.00	26.89	0.002	0.002	0.002	4,200.00	112.94	169.41
As 6	135.00	125.00	150.00	Bajo	1.00	1.00	26.89	0.002	0.002	0.002	4,200.00	112.94	141.17
As 7	160.00	100.00	150.00	Bajo	1.00	1.00	26.89	0.002	0.002	0.002	4,200.00	112.94	112.94
As 8	185.00	75.00	150.00	Bajo	1.00	1.00	26.89	0.003	0.002	0.002	4,200.00	112.94	84.70
As 9	210.00	50.00	150.00	Bajo	1.00	1.00	26.89	0.003	0.002	0.002	4,200.00	112.94	56.47
As 10	235.00	25.00	150.00	Bajo	1.00	1.00	26.89	0.003	0.002	0.002	4,200.00	112.94	28.23
As 11	260.00	0.00	150.00	Bajo	1.00	1.00	26.89	0.003	0.002	0.002	4,200.00	112.94	0.00
As 12	285.00	-25.00	150.00	Bajo	1.00	1.00	26.89	0.003	0.002	0.002	4,200.00	112.94	-28.23
As 13	310.00	-50.00	150.00	Bajo	1.00	-1.00	26.89	0.003	0.002	0.002	4,200.00	112.94	56.47
As 14	335.00	75.00	150.00	Bajo	1.00	-1.00	26.89	0.003	0.002	0.002	4,200.00	112.94	-84.70
As 15	360.00	100.00	150.00	Bajo	1.00	-1.00	26.89	0.002	0.002	0.002	4,200.00	112.94	-112.94
As 16	385.00	125.00	150.00	Bajo	1.00	-1.00	26.89	0.002	0.002	0.002	4,200.00	112.94	-141.17
As 17	410.00	150.00	150.00	Bajo	1.00	-1.00	26.89	0.002	0.002	0.002	4,200.00	112.94	-169.41
As 18	435.00	175.00	150.00	Bajo	1.00	-1.00	26.89	0.002	0.002	0.002	4,200.00	112.94	-197.64
As 19	460.00	200.00	150.00	Bajo	1.00	-1.00	26.89	0.002	0.002	0.002	3,997.32	107.49	-214.98
As 20	485.00	225.00	150.00	Bajo	1.00	-1.00	26.89	0.002	0.002	0.002	3,709.48	99.75	-224.43
As 21	510.00	250.00	150.00	Bajo	1.00	-1.00	26.89	0.002	0.002	0.002	3,421.64	92.01	-230.02
Aportes Totales del Acero												2,292.56	112.94

Cuadro Resumen			
C =			
	Concreto	Acero	Total
P (ton)	15627.675	2,292.56	17,920.23
M (ton m)	6426.881344	112.94	6,539.82
Φ P (ton)			11648.15116
Φ M (ton m)			4250.882573

Valores Bajo el Cb

Carga y Momentos C=280 cm

Dato	Valor	Unidad
C	280	cm
a	238	cm
Area Comprimida	35700	cm2

Aporte del Concreto

Carga	P (ton)	M (ton m)
Valor	8496.6	11980.206

Aporte del Acero

Material	di	Brazo de Palanca	b	Condicion	Signo P	Signo M	As	es o e's	ey	ε	fs	Aporte P (ton)	Aporte M (ton m)
As 1	10.00	250.00	150.00	Bajo	1.00	1.00	26.89	0.000	0.002	0.000	1,005.88	27.05	67.62
As 2	35.00	225.00	150.00	Bajo	1.00	1.00	26.89	0.001	0.002	0.001	1,535.29	41.28	92.89
As 3	60.00	200.00	150.00	Bajo	1.00	1.00	26.89	0.001	0.002	0.001	2,064.71	55.52	111.04
As 4	85.00	175.00	150.00	Bajo	1.00	1.00	26.89	0.001	0.002	0.001	2,594.12	69.76	122.07
As 5	110.00	150.00	150.00	Bajo	1.00	1.00	26.89	0.001	0.002	0.001	3,123.53	83.99	125.99
As 6	135.00	125.00	150.00	Bajo	1.00	1.00	26.89	0.002	0.002	0.002	3,652.94	98.23	122.78
As 7	160.00	100.00	150.00	Bajo	1.00	1.00	26.89	0.002	0.002	0.002	4,182.35	112.46	112.46
As 8	185.00	75.00	150.00	Bajo	1.00	1.00	26.89	0.002	0.002	0.002	4,200.00	112.94	84.70
As 9	210.00	50.00	150.00	Bajo	1.00	1.00	26.89	0.002	0.002	0.002	4,200.00	112.94	56.47
As 10	235.00	25.00	150.00	Bajo	1.00	1.00	26.89	0.003	0.002	0.002	4,200.00	112.94	28.23
As 11	260.00	0.00	150.00	Bajo	1.00	1.00	26.89	0.003	0.002	0.002	4,200.00	112.94	0.00
As 12	285.00	-25.00	150.00	Sobre	-1.00	-1.00	26.89	0.003	0.002	0.002	4,200.00	-112.94	28.23
As 13	310.00	-50.00	150.00	Sobre	-1.00	1.00	26.89	0.004	0.002	0.002	4,200.00	-112.94	-56.47
As 14	335.00	75.00	150.00	Sobre	-1.00	1.00	26.89	0.002	0.002	0.002	4,200.00	-112.94	84.70
As 15	360.00	100.00	150.00	Sobre	-1.00	1.00	26.89	0.002	0.002	0.002	4,182.35	-112.46	112.46
As 16	385.00	125.00	150.00	Sobre	-1.00	1.00	26.89	0.002	0.002	0.002	3,652.94	-98.23	122.78
As 17	410.00	150.00	150.00	Sobre	-1.00	1.00	26.89	0.001	0.002	0.001	3,123.53	-83.99	125.99
As 18	435.00	175.00	150.00	Sobre	-1.00	1.00	26.89	0.001	0.002	0.001	2,594.12	-69.76	122.07
As 19	460.00	200.00	150.00	Sobre	-1.00	1.00	26.89	0.001	0.002	0.001	2,064.71	-55.52	111.04
As 20	485.00	225.00	150.00	Sobre	-1.00	1.00	26.89	0.001	0.002	0.001	1,535.29	-41.28	92.89
As 21	510.00	250.00	150.00	Sobre	-1.00	1.00	26.89	0.000	0.002	0.000	1,005.88	-27.05	67.62
Aportes Totales del Acero												112.94	1,735.59

Cuadro Resumen			
C =			
	Concreto	Acero	Total
P (ton)	8496.6	112.94	8,609.54
M (ton m)	11980.206	1,735.59	13,715.80
Φ P (ton)			5596.1997
Φ M (ton m)			8915.26826

Carga y Momentos C=260 cm

Dato	Valor	Unidad
C	260	cm
a	221	cm
Area Comprimida	33150	cm2

Aporte del Concreto

Carga	P (ton)	M (ton m)
Valor	7889.7	11795.1015

Aporte del Acero

Material	di	Brazo de Palanca	b	Condicion	Signo P	Signo M	As	es o e's	ey	ε	fs	Aporte P (ton)	Aporte M (ton m)
As 1	10.00	250.00	150.00	Bajo	1.00	1.00	26.89	0.000	0.002	0.000	598.64	16.10	40.24
As 2	35.00	225.00	150.00	Bajo	1.00	1.00	26.89	0.001	0.002	0.001	1,168.78	31.43	70.71
As 3	60.00	200.00	150.00	Bajo	1.00	1.00	26.89	0.001	0.002	0.001	1,738.91	46.76	93.52
As 4	85.00	175.00	150.00	Bajo	1.00	1.00	26.89	0.001	0.002	0.001	2,309.05	62.09	108.66
As 5	110.00	150.00	150.00	Bajo	1.00	1.00	26.89	0.001	0.002	0.001	2,879.19	77.42	116.13
As 6	135.00	125.00	150.00	Bajo	1.00	1.00	26.89	0.002	0.002	0.002	3,449.32	92.75	115.94
As 7	160.00	100.00	150.00	Bajo	1.00	1.00	26.89	0.002	0.002	0.002	4,019.46	108.08	108.08
As 8	185.00	75.00	150.00	Bajo	1.00	1.00	26.89	0.002	0.002	0.002	4,200.00	112.94	84.70
As 9	210.00	50.00	150.00	Bajo	1.00	1.00	26.89	0.002	0.002	0.002	4,200.00	112.94	56.47
As 10	235.00	25.00	150.00	Bajo	1.00	1.00	26.89	0.003	0.002	0.002	4,200.00	112.94	28.23
As 11	260.00	0.00	150.00	Sobre	-1.00	-1.00	26.89	0.003	0.002	0.002	4,200.00	-112.94	0.00
As 12	285.00	-25.00	150.00	Sobre	-1.00	-1.00	26.89	0.003	0.002	0.002	4,200.00	-112.94	28.23
As 13	310.00	-50.00	150.00	Sobre	-1.00	1.00	26.89	0.004	0.002	0.002	4,200.00	-112.94	-56.47
As 14	335.00	75.00	150.00	Sobre	-1.00	1.00	26.89	0.002	0.002	0.002	4,200.00	-112.94	84.70
As 15	360.00	100.00	150.00	Sobre	-1.00	1.00	26.89	0.002	0.002	0.002	4,019.46	-108.08	108.08
As 16	385.00	125.00	150.00	Sobre	-1.00	1.00	26.89	0.002	0.002	0.002	3,449.32	-92.75	115.94
As 17	410.00	150.00	150.00	Sobre	-1.00	1.00	26.89	0.001	0.002	0.001	2,879.19	-77.42	116.13
As 18	435.00	175.00	150.00	Sobre	-1.00	1.00	26.89	0.001	0.002	0.001	2,309.05	-62.09	108.66
As 19	460.00	200.00	150.00	Sobre	-1.00	1.00	26.89	0.001	0.002	0.001	1,738.91	-46.76	93.52
As 20	485.00	225.00	150.00	Sobre	-1.00	1.00	26.89	0.001	0.002	0.001	1,168.78	-31.43	70.71
As 21	510.00	250.00	150.00	Sobre	-1.00	1.00	26.89	0.000	0.002	0.000	598.64	-16.10	40.24
Aportes Totales del Acero												-112.94	1,532.46

Cuadro Resumen			
C =			
	Concreto	Acero	Total
P (ton)	7889.7	-112.94	7,776.76
M (ton m)	11795.1015	1,532.46	13,327.56
Φ P (ton)			5054.8953
Φ M (ton m)			8662.912526

Carga y Momentos C=240 cm

Dato	Valor	Unidad
C	240	cm
a	204	cm
Area Comprimida	30600	cm2

Aporte del Concreto

Carga	P (ton)	M (ton m)
Valor	7282.8	11506.824

Aporte del Acero

Material	di	Brazo de Palanca	b	Condicion	Signo P	Signo M	As	es o e's	ey	ε	fs	Aporte P (ton)	Aporte M (ton m)
As 1	10.00	250.00	150.00	Bajo	1.00	1.00	26.89	0.000	0.002	0.000	123.53	3.32	8.30
As 2	35.00	225.00	150.00	Bajo	1.00	1.00	26.89	0.000	0.002	0.000	741.18	19.93	44.84
As 3	60.00	200.00	150.00	Bajo	1.00	1.00	26.89	0.001	0.002	0.001	1,358.82	36.54	73.08
As 4	85.00	175.00	150.00	Bajo	1.00	1.00	26.89	0.001	0.002	0.001	1,976.47	53.15	93.01
As 5	110.00	150.00	150.00	Bajo	1.00	1.00	26.89	0.001	0.002	0.001	2,594.12	69.76	104.63
As 6	135.00	125.00	150.00	Bajo	1.00	1.00	26.89	0.002	0.002	0.002	3,211.76	86.36	107.96
As 7	160.00	100.00	150.00	Bajo	1.00	1.00	26.89	0.002	0.002	0.002	3,829.41	102.97	102.97
As 8	185.00	75.00	150.00	Bajo	1.00	1.00	26.89	0.002	0.002	0.002	4,200.00	112.94	84.70
As 9	210.00	50.00	150.00	Bajo	1.00	1.00	26.89	0.002	0.002	0.002	4,200.00	112.94	56.47
As 10	235.00	25.00	150.00	Bajo	1.00	1.00	26.89	0.003	0.002	0.002	4,200.00	112.94	28.23
As 11	260.00	0.00	150.00	Sobre	-1.00	-1.00	26.89	0.003	0.002	0.002	4,200.00	-112.94	0.00
As 12	285.00	-25.00	150.00	Sobre	-1.00	-1.00	26.89	0.003	0.002	0.002	4,200.00	-112.94	28.23
As 13	310.00	-50.00	150.00	Sobre	-1.00	1.00	26.89	0.004	0.002	0.002	4,200.00	-112.94	-56.47
As 14	335.00	75.00	150.00	Sobre	-1.00	1.00	26.89	0.002	0.002	0.002	4,200.00	-112.94	84.70
As 15	360.00	100.00	150.00	Sobre	-1.00	1.00	26.89	0.002	0.002	0.002	3,829.41	-102.97	102.97
As 16	385.00	125.00	150.00	Sobre	-1.00	1.00	26.89	0.002	0.002	0.002	3,211.76	-86.36	107.96
As 17	410.00	150.00	150.00	Sobre	-1.00	1.00	26.89	0.001	0.002	0.001	2,594.12	-69.76	104.63
As 18	435.00	175.00	150.00	Sobre	-1.00	1.00	26.89	0.001	0.002	0.001	1,976.47	-53.15	93.01
As 19	460.00	200.00	150.00	Sobre	-1.00	1.00	26.89	0.001	0.002	0.001	1,358.82	-36.54	73.08
As 20	485.00	225.00	150.00	Sobre	-1.00	1.00	26.89	0.000	0.002	0.000	741.18	-19.93	44.84
As 21	510.00	250.00	150.00	Sobre	-1.00	1.00	26.89	0.000	0.002	0.000	123.53	-3.32	8.30
Aportes Totales del Acero												-112.94	1,295.47

Cuadro Resumen			
C =			
	Concreto	Acero	Total
P (ton)	7282.8	-112.94	7,169.86
M (ton m)	11506.824	1,295.47	12,802.29
Φ P (ton)			4660.4103
Φ M (ton m)			8321.488041

Carga y Momentos C=220 cm

Dato	Valor	Unidad
C	220	cm
a	187	cm
Area Comprimida	28050	cm2

Aporte del Concreto

Carga	P (ton)	M (ton m)
Valor	6675.9	11115.3735

Aporte del Acero

Material	di	Brazo de Palanca	b	Condicion	Signo P	Signo M	As	es o e's	ey	ε	fs	Aporte P (ton)	Aporte M (ton m)
As 1	10.00	250.00	150.00	Bajo	1.00	1.00	26.89	0.000	0.002	0.000	437.97	11.78	29.44
As 2	35.00	225.00	150.00	Bajo	1.00	1.00	26.89	0.000	0.002	0.000	235.83	6.34	14.27
As 3	60.00	200.00	150.00	Bajo	1.00	1.00	26.89	0.000	0.002	0.000	909.63	24.46	48.92
As 4	85.00	175.00	150.00	Bajo	1.00	1.00	26.89	0.001	0.002	0.001	1,583.42	42.58	74.51
As 5	110.00	150.00	150.00	Bajo	1.00	1.00	26.89	0.001	0.002	0.001	2,257.22	60.70	91.04
As 6	135.00	125.00	150.00	Bajo	1.00	1.00	26.89	0.001	0.002	0.001	2,931.02	78.82	98.52
As 7	160.00	100.00	150.00	Bajo	1.00	1.00	26.89	0.002	0.002	0.002	3,604.81	96.93	96.93
As 8	185.00	75.00	150.00	Bajo	1.00	1.00	26.89	0.002	0.002	0.002	4,200.00	112.94	84.70
As 9	210.00	50.00	150.00	Bajo	1.00	1.00	26.89	0.002	0.002	0.002	4,200.00	112.94	56.47
As 10	235.00	25.00	150.00	Sobre	-1.00	-1.00	26.89	0.003	0.002	0.002	4,200.00	-112.94	-28.23
As 11	260.00	0.00	150.00	Sobre	-1.00	-1.00	26.89	0.003	0.002	0.002	4,200.00	-112.94	0.00
As 12	285.00	-25.00	150.00	Sobre	-1.00	-1.00	26.89	0.003	0.002	0.002	4,200.00	-112.94	28.23
As 13	310.00	-50.00	150.00	Sobre	-1.00	1.00	26.89	0.004	0.002	0.002	4,200.00	-112.94	-56.47
As 14	335.00	75.00	150.00	Sobre	-1.00	1.00	26.89	0.002	0.002	0.002	4,200.00	-112.94	84.70
As 15	360.00	100.00	150.00	Sobre	-1.00	1.00	26.89	0.002	0.002	0.002	3,604.81	-96.93	96.93
As 16	385.00	125.00	150.00	Sobre	-1.00	1.00	26.89	0.001	0.002	0.001	2,931.02	-78.82	98.52
As 17	410.00	150.00	150.00	Sobre	-1.00	1.00	26.89	0.001	0.002	0.001	2,257.22	-60.70	91.04
As 18	435.00	175.00	150.00	Sobre	-1.00	1.00	26.89	0.001	0.002	0.001	1,583.42	-42.58	74.51
As 19	460.00	200.00	150.00	Sobre	-1.00	1.00	26.89	0.000	0.002	0.000	909.63	-24.46	48.92
As 20	485.00	225.00	150.00	Sobre	-1.00	1.00	26.89	0.000	0.002	0.000	235.83	-6.34	14.27
As 21	510.00	250.00	150.00	Sobre	-1.00	1.00	26.89	0.000	0.002	0.000	437.97	-11.78	29.44
Aportes Totales del Acero												-338.81	1,076.69

Cuadro Resumen			
C =			
	Concreto	Acero	Total
P (ton)	6675.9	-338.81	6,337.09
M (ton m)	11115.3735	1,076.69	12,192.06
Φ P (ton)			4119.1059
Φ M (ton m)			7924.838458

Carga y Momentos C=200 cm

Dato	Valor	Unidad
C	200	cm
a	170	cm
Area Comprimida	25500	cm2

Aporte del Concreto

Carga	P (ton)	M (ton m)
Valor	6069	10620.75

Aporte del Acero

Material	di	Brazo de Palanca	b	Condicion	Signo P	Signo M	As	es o e's	ey	ε	fs	Aporte P (ton)	Aporte M (ton m)
As 1	10.00	250.00	150.00	Bajo	1.00	1.00	26.89	0.001	0.002	0.001	1,111.76	29.90	74.74
As 2	35.00	225.00	150.00	Bajo	1.00	1.00	26.89	0.000	0.002	0.000	370.59	9.97	22.42
As 3	60.00	200.00	150.00	Bajo	1.00	1.00	26.89	0.000	0.002	0.000	370.59	9.97	19.93
As 4	85.00	175.00	150.00	Bajo	1.00	1.00	26.89	0.001	0.002	0.001	1,111.76	29.90	52.32
As 5	110.00	150.00	150.00	Bajo	1.00	1.00	26.89	0.001	0.002	0.001	1,852.94	49.83	74.74
As 6	135.00	125.00	150.00	Bajo	1.00	1.00	26.89	0.001	0.002	0.001	2,594.12	69.76	87.19
As 7	160.00	100.00	150.00	Bajo	1.00	1.00	26.89	0.002	0.002	0.002	3,335.29	89.69	89.69
As 8	185.00	75.00	150.00	Bajo	1.00	1.00	26.89	0.002	0.002	0.002	4,076.47	109.62	82.21
As 9	210.00	50.00	150.00	Sobre	-1.00	-1.00	26.89	0.002	0.002	0.002	4,200.00	-112.94	-56.47
As 10	235.00	25.00	150.00	Sobre	-1.00	-1.00	26.89	0.003	0.002	0.002	4,200.00	-112.94	-28.23
As 11	260.00	0.00	150.00	Sobre	-1.00	-1.00	26.89	0.003	0.002	0.002	4,200.00	-112.94	0.00
As 12	285.00	-25.00	150.00	Sobre	-1.00	-1.00	26.89	0.003	0.002	0.002	4,200.00	-112.94	28.23
As 13	310.00	-50.00	150.00	Sobre	-1.00	1.00	26.89	0.004	0.002	0.002	4,200.00	-112.94	-56.47
As 14	335.00	75.00	150.00	Sobre	-1.00	1.00	26.89	0.002	0.002	0.002	4,076.47	-109.62	82.21
As 15	360.00	100.00	150.00	Sobre	-1.00	1.00	26.89	0.002	0.002	0.002	3,335.29	-89.69	89.69
As 16	385.00	125.00	150.00	Sobre	-1.00	1.00	26.89	0.001	0.002	0.001	2,594.12	-69.76	87.19
As 17	410.00	150.00	150.00	Sobre	-1.00	1.00	26.89	0.001	0.002	0.001	1,852.94	-49.83	74.74
As 18	435.00	175.00	150.00	Sobre	-1.00	1.00	26.89	0.001	0.002	0.001	1,111.76	-29.90	52.32
As 19	460.00	200.00	150.00	Sobre	-1.00	1.00	26.89	0.000	0.002	0.000	370.59	-9.97	19.93
As 20	485.00	225.00	150.00	Sobre	-1.00	1.00	26.89	0.000	0.002	0.000	370.59	-9.97	22.42
As 21	510.00	250.00	150.00	Sobre	-1.00	1.00	26.89	0.001	0.002	0.001	1,111.76	-29.90	74.74
Aportes Totales del Acero												-564.69	893.54

Cuadro Resumen			
C =			
	Concreto	Acero	Total
P (ton)	6069	-564.69	5,504.31
M (ton m)	10620.75	893.54	11,514.29
Φ P (ton)			3577.8015
Φ M (ton m)			7484.287774

Carga y Momentos C=180 cm

Dato	Valor	Unidad
C	180	cm
a	153	cm
Area Comprimida	22950	cm2

Aporte del Concreto

Carga	P (ton)	M (ton m)
Valor	5462.1	10022.9535

Aporte del Acero													
Material	di	Brazo de Palanca	b	Condicion	Signo P	Signo M	As	es o e's	ey	ε	fs	Aporte P (ton)	Aporte M (ton m)
As 1	10.00	250.00	150.00	Bajo	1.00	1.00	26.89	0.001	0.002	0.001	1,935.29	52.04	130.10
As 2	35.00	225.00	150.00	Bajo	1.00	1.00	26.89	0.001	0.002	0.001	1,111.76	29.90	67.26
As 3	60.00	200.00	150.00	Bajo	1.00	1.00	26.89	0.000	0.002	0.000	288.24	7.75	15.50
As 4	85.00	175.00	150.00	Bajo	1.00	1.00	26.89	0.000	0.002	0.000	535.29	14.39	25.19
As 5	110.00	150.00	150.00	Bajo	1.00	1.00	26.89	0.001	0.002	0.001	1,358.82	36.54	54.81
As 6	135.00	125.00	150.00	Bajo	1.00	1.00	26.89	0.001	0.002	0.001	2,182.35	58.68	73.35
As 7	160.00	100.00	150.00	Bajo	1.00	1.00	26.89	0.001	0.002	0.001	3,005.88	80.83	80.83
As 8	185.00	75.00	150.00	Sobre	-1.00	-1.00	26.89	0.002	0.002	0.002	3,829.41	-102.97	-77.23
As 9	210.00	50.00	150.00	Sobre	-1.00	-1.00	26.89	0.002	0.002	0.002	4,200.00	-112.94	-56.47
As 10	235.00	25.00	150.00	Sobre	-1.00	-1.00	26.89	0.003	0.002	0.002	4,200.00	-112.94	-28.23
As 11	260.00	0.00	150.00	Sobre	-1.00	-1.00	26.89	0.003	0.002	0.002	4,200.00	-112.94	0.00
As 12	285.00	-25.00	150.00	Sobre	-1.00	-1.00	26.89	0.003	0.002	0.002	4,200.00	-112.94	28.23
As 13	310.00	-50.00	150.00	Sobre	-1.00	1.00	26.89	0.004	0.002	0.002	4,200.00	-112.94	-56.47
As 14	335.00	75.00	150.00	Sobre	-1.00	1.00	26.89	0.002	0.002	0.002	3,829.41	-102.97	77.23
As 15	360.00	100.00	150.00	Sobre	-1.00	1.00	26.89	0.001	0.002	0.001	3,005.88	-80.83	80.83
As 16	385.00	125.00	150.00	Sobre	-1.00	1.00	26.89	0.001	0.002	0.001	2,182.35	-58.68	73.35
As 17	410.00	150.00	150.00	Sobre	-1.00	1.00	26.89	0.001	0.002	0.001	1,358.82	-36.54	54.81
As 18	435.00	175.00	150.00	Sobre	-1.00	1.00	26.89	0.000	0.002	0.000	535.29	-14.39	25.19
As 19	460.00	200.00	150.00	Sobre	-1.00	1.00	26.89	0.000	0.002	0.000	288.24	-7.75	15.50
As 20	485.00	225.00	150.00	Sobre	-1.00	1.00	26.89	0.001	0.002	0.001	1,111.76	-29.90	67.26
As 21	510.00	250.00	150.00	Sobre	-1.00	1.00	26.89	0.001	0.002	0.001	1,935.29	-52.04	130.10
Aportes Totales del Acero												-770.64	781.15

Cuadro Resumen			
C =			
	Concreto	Acero	Total
P (ton)	5462.1	-770.64	4,691.46
M (ton m)	10022.9535	781.15	10,804.11
Φ P (ton)			3049.451753
Φ M (ton m)			7022.6702

Carga y Momentos C=160 cm

Dato	Valor	Unidad
C	160	cm
a	136	cm
Area Comprimida	20400	cm2

Aporte del Concreto

Carga	P (ton)	M (ton m)
Valor	4855.2	9321.984

Aporte del Acero

Material	di	Brazo de Palanca	b	Condicion	Signo P	Signo M	As	es o e's	ey	ε	fs	Aporte P (ton)	Aporte M (ton m)
As 1	10.00	250.00	150.00	Bajo	1.00	1.00	26.89	0.001	0.002	0.001	2,964.71	79.72	199.30
As 2	35.00	225.00	150.00	Bajo	1.00	1.00	26.89	0.001	0.002	0.001	2,038.24	54.81	123.32
As 3	60.00	200.00	150.00	Bajo	1.00	1.00	26.89	0.001	0.002	0.001	1,111.76	29.90	59.79
As 4	85.00	175.00	150.00	Bajo	1.00	1.00	26.89	0.000	0.002	0.000	185.29	4.98	8.72
As 5	110.00	150.00	150.00	Bajo	1.00	1.00	26.89	0.000	0.002	0.000	741.18	19.93	29.90
As 6	135.00	125.00	150.00	Bajo	1.00	1.00	26.89	0.001	0.002	0.001	1,667.65	44.84	56.05
As 7	160.00	100.00	150.00	Sobre	-1.00	-1.00	26.89	0.001	0.002	0.001	2,594.12	-69.76	-69.76
As 8	185.00	75.00	150.00	Sobre	-1.00	-1.00	26.89	0.002	0.002	0.002	3,520.59	-94.67	-71.00
As 9	210.00	50.00	150.00	Sobre	-1.00	-1.00	26.89	0.002	0.002	0.002	4,200.00	-112.94	-56.47
As 10	235.00	25.00	150.00	Sobre	-1.00	-1.00	26.89	0.003	0.002	0.002	4,200.00	-112.94	-28.23
As 11	260.00	0.00	150.00	Sobre	-1.00	-1.00	26.89	0.003	0.002	0.002	4,200.00	-112.94	0.00
As 12	285.00	-25.00	150.00	Sobre	-1.00	-1.00	26.89	0.003	0.002	0.002	4,200.00	-112.94	28.23
As 13	310.00	-50.00	150.00	Sobre	-1.00	1.00	26.89	0.004	0.002	0.002	4,200.00	-112.94	-56.47
As 14	335.00	75.00	150.00	Sobre	-1.00	1.00	26.89	0.002	0.002	0.002	3,520.59	-94.67	71.00
As 15	360.00	100.00	150.00	Sobre	-1.00	1.00	26.89	0.001	0.002	0.001	2,594.12	-69.76	69.76
As 16	385.00	125.00	150.00	Sobre	-1.00	1.00	26.89	0.001	0.002	0.001	1,667.65	-44.84	56.05
As 17	410.00	150.00	150.00	Sobre	-1.00	1.00	26.89	0.000	0.002	0.000	741.18	-19.93	29.90
As 18	435.00	175.00	150.00	Sobre	-1.00	1.00	26.89	0.000	0.002	0.000	185.29	-4.98	8.72
As 19	460.00	200.00	150.00	Sobre	-1.00	1.00	26.89	0.001	0.002	0.001	1,111.76	-29.90	59.79
As 20	485.00	225.00	150.00	Sobre	-1.00	1.00	26.89	0.001	0.002	0.001	2,038.24	-54.81	123.32
As 21	510.00	250.00	150.00	Sobre	-1.00	1.00	26.89	0.001	0.002	0.001	2,964.71	-79.72	199.30
Aportes Totales del Acero												-893.54	841.22

Cuadro Resumen			
C =			
	Concreto	Acero	Total
P (ton)	4855.2	-893.54	3,961.66
M (ton m)	9321.984	841.22	10,163.21
Φ P (ton)			2575.079726
Φ M (ton m)			6606.08391

Carga y Momentos C=140 cm

Dato	Valor	Unidad
C	140	cm
a	119	cm
Area Comprimida	17850	cm2

Aporte del Concreto

Carga	P (ton)	M (ton m)
Valor	4248.3	8517.8415

Aporte del Acero

Material	di	Brazo de Palanca	b	Condicion	Signo P	Signo M	As	es o e's	ey	ε	fs	Aporte P (ton)	Aporte M (ton m)
As 1	10.00	250.00	150.00	Bajo	1.00	1.00	26.89	0.002	0.002	0.002	4,200.00	112.94	282.35
As 2	35.00	225.00	150.00	Bajo	1.00	1.00	26.89	0.002	0.002	0.002	3,229.41	86.84	195.39
As 3	60.00	200.00	150.00	Bajo	1.00	1.00	26.89	0.001	0.002	0.001	2,170.59	58.37	116.73
As 4	85.00	175.00	150.00	Bajo	1.00	1.00	26.89	0.001	0.002	0.001	1,111.76	29.90	52.32
As 5	110.00	150.00	150.00	Bajo	1.00	1.00	26.89	0.000	0.002	0.000	52.94	1.42	2.14
As 6	135.00	125.00	150.00	Bajo	1.00	1.00	26.89	0.000	0.002	0.000	1,005.88	27.05	33.81
As 7	160.00	100.00	150.00	Sobre	-1.00	1.00	26.89	0.001	0.002	0.001	2,064.71	-55.52	55.52
As 8	185.00	75.00	150.00	Sobre	-1.00	1.00	26.89	0.001	0.002	0.001	3,123.53	-83.99	62.99
As 9	210.00	50.00	150.00	Sobre	-1.00	1.00	26.89	0.002	0.002	0.002	4,182.35	-112.46	56.23
As 10	235.00	25.00	150.00	Sobre	-1.00	1.00	26.89	0.002	0.002	0.002	4,200.00	-112.94	28.23
As 11	260.00	0.00	150.00	Sobre	-1.00	1.00	26.89	0.003	0.002	0.002	4,200.00	-112.94	0.00
As 12	285.00	-25.00	150.00	Sobre	-1.00	1.00	26.89	0.004	0.002	0.002	4,200.00	-112.94	-28.23
As 13	310.00	-50.00	150.00	Sobre	-1.00	1.00	26.89	0.004	0.002	0.002	4,200.00	-112.94	-56.47
As 14	335.00	75.00	150.00	Sobre	-1.00	1.00	26.89	0.001	0.002	0.001	3,123.53	-83.99	62.99
As 15	360.00	100.00	150.00	Sobre	-1.00	1.00	26.89	0.001	0.002	0.001	2,064.71	-55.52	55.52
As 16	385.00	125.00	150.00	Sobre	-1.00	1.00	26.89	0.000	0.002	0.000	1,005.88	-27.05	33.81
As 17	410.00	150.00	150.00	Sobre	-1.00	1.00	26.89	0.000	0.002	0.000	52.94	-1.42	2.14
As 18	435.00	175.00	150.00	Sobre	-1.00	1.00	26.89	0.001	0.002	0.001	1,111.76	-29.90	52.32
As 19	460.00	200.00	150.00	Sobre	-1.00	1.00	26.89	0.001	0.002	0.001	2,170.59	-58.37	116.73
As 20	485.00	225.00	150.00	Sobre	-1.00	1.00	26.89	0.002	0.002	0.002	3,229.41	-86.84	195.39
As 21	510.00	250.00	150.00	Sobre	-1.00	1.00	26.89	0.002	0.002	0.002	4,200.00	-112.94	282.35
Aportes Totales del Acero												-843.24	1,602.25

Cuadro Resumen			
C =			
	Concreto	Acero	Total
P (ton)	4248.3	-843.24	3,405.06
M (ton m)	8517.8415	1,602.25	10,120.09
Φ P (ton)			2213.289803
Φ M (ton m)			6578.058538

Carga y Momentos C=120 cm

Dato	Valor	Unidad
C	120	cm
a	102	cm
Area Comprimida	15300	cm2

Aporte del Concreto

Carga	P (ton)	M (ton m)
Valor	3641.4	7610.526

Aporte del Acero

Material	di	Brazo de Palanca	b	Condicion	Signo P	Signo M	As	es o e's	ey	ε	fs	Aporte P (ton)	Aporte M (ton m)
As 1	10.00	250.00	150.00	Bajo	1.00	1.00	26.89	0.003	0.002	0.002	4,200.00	112.94	282.35
As 2	35.00	225.00	150.00	Bajo	1.00	1.00	26.89	0.002	0.002	0.002	4,200.00	112.94	254.11
As 3	60.00	200.00	150.00	Bajo	1.00	1.00	26.89	0.002	0.002	0.002	3,582.35	96.33	192.66
As 4	85.00	175.00	150.00	Bajo	1.00	1.00	26.89	0.001	0.002	0.001	2,347.06	63.11	110.45
As 5	110.00	150.00	150.00	Bajo	1.00	1.00	26.89	0.001	0.002	0.001	1,111.76	29.90	44.84
As 6	135.00	125.00	150.00	Sobre	-1.00	-1.00	26.89	0.000	0.002	0.000	123.53	-3.32	-4.15
As 7	160.00	100.00	150.00	Sobre	-1.00	-1.00	26.89	0.001	0.002	0.001	1,358.82	-36.54	-36.54
As 8	185.00	75.00	150.00	Sobre	-1.00	-1.00	26.89	0.001	0.002	0.001	2,594.12	-69.76	-52.32
As 9	210.00	50.00	150.00	Sobre	-1.00	-1.00	26.89	0.002	0.002	0.002	3,829.41	-102.97	-51.49
As 10	235.00	25.00	150.00	Sobre	-1.00	-1.00	26.89	0.002	0.002	0.002	4,200.00	-112.94	-28.23
As 11	260.00	0.00	150.00	Sobre	-1.00	-1.00	26.89	0.003	0.002	0.002	4,200.00	-112.94	0.00
As 12	285.00	-25.00	150.00	Sobre	-1.00	-1.00	26.89	0.004	0.002	0.002	4,200.00	-112.94	28.23
As 13	310.00	-50.00	150.00	Sobre	-1.00	1.00	26.89	0.004	0.002	0.002	4,200.00	-112.94	-56.47
As 14	335.00	75.00	150.00	Sobre	-1.00	1.00	26.89	0.001	0.002	0.001	2,594.12	-69.76	52.32
As 15	360.00	100.00	150.00	Sobre	-1.00	1.00	26.89	0.001	0.002	0.001	1,358.82	-36.54	36.54
As 16	385.00	125.00	150.00	Sobre	-1.00	1.00	26.89	0.000	0.002	0.000	123.53	-3.32	4.15
As 17	410.00	150.00	150.00	Sobre	-1.00	1.00	26.89	0.001	0.002	0.001	1,111.76	-29.90	44.84
As 18	435.00	175.00	150.00	Sobre	-1.00	1.00	26.89	0.001	0.002	0.001	2,347.06	-63.11	110.45
As 19	460.00	200.00	150.00	Sobre	-1.00	1.00	26.89	0.002	0.002	0.002	3,582.35	-96.33	192.66
As 20	485.00	225.00	150.00	Sobre	-1.00	1.00	26.89	0.002	0.002	0.002	4,200.00	-112.94	254.11
As 21	510.00	250.00	150.00	Sobre	-1.00	1.00	26.89	0.003	0.002	0.002	4,200.00	-112.94	282.35
Aportes Totales del Acero												-773.96	1,660.85

Cuadro Resumen			
C =			
	Concreto	Acero	Total
P (ton)	3641.4	-773.96	2,867.44
M (ton m)	7610.526	1,660.85	9,271.38
Φ	0.723529412		
Φ P (ton)			2074.679007
Φ M (ton m)			6708.115352

Carga y Momentos C=100 cm

Dato	Valor	Unidad
C	100	cm
a	85	cm
Area Comprimida	12750	cm2

Aporte del Concreto

Carga	P (ton)	M (ton m)
Valor	3034.5	6600.0375

Aporte del Acero

Material	di	Brazo de Palanca	b	Condicion	Signo P	Signo M	As	es o e's	ey	ε	fs	Aporte P (ton)	Aporte M (ton m)
As 1	10.00	250.00	150.00	Bajo	1.00	1.00	26.89	0.004	0.002	0.002	4,200.00	112.94	282.35
As 2	35.00	225.00	150.00	Bajo	1.00	1.00	26.89	0.003	0.002	0.002	4,200.00	112.94	254.11
As 3	60.00	200.00	150.00	Bajo	1.00	1.00	26.89	0.003	0.002	0.002	4,200.00	112.94	225.88
As 4	85.00	175.00	150.00	Bajo	1.00	1.00	26.89	0.002	0.002	0.002	4,076.47	109.62	191.83
As 5	110.00	150.00	150.00	Sobre	-1.00	-1.00	26.89	0.001	0.002	0.001	2,594.12	-69.76	-104.63
As 6	135.00	125.00	150.00	Sobre	-1.00	-1.00	26.89	0.001	0.002	0.001	1,111.76	-29.90	-37.37
As 7	160.00	100.00	150.00	Sobre	-1.00	-1.00	26.89	0.000	0.002	0.000	370.59	-9.97	-9.97
As 8	185.00	75.00	150.00	Sobre	-1.00	-1.00	26.89	0.001	0.002	0.001	1,852.94	-49.83	-37.37
As 9	210.00	50.00	150.00	Sobre	-1.00	-1.00	26.89	0.002	0.002	0.002	3,335.29	-89.69	-44.84
As 10	235.00	25.00	150.00	Sobre	-1.00	-1.00	26.89	0.002	0.002	0.002	4,200.00	-112.94	-28.23
As 11	260.00	0.00	150.00	Sobre	-1.00	-1.00	26.89	0.003	0.002	0.002	4,200.00	-112.94	0.00
As 12	285.00	-25.00	150.00	Sobre	-1.00	-1.00	26.89	0.004	0.002	0.002	4,200.00	-112.94	28.23
As 13	310.00	-50.00	150.00	Sobre	-1.00	1.00	26.89	0.004	0.002	0.002	4,200.00	-112.94	-56.47
As 14	335.00	75.00	150.00	Sobre	-1.00	1.00	26.89	0.001	0.002	0.001	1,852.94	-49.83	37.37
As 15	360.00	100.00	150.00	Sobre	-1.00	1.00	26.89	0.000	0.002	0.000	370.59	-9.97	9.97
As 16	385.00	125.00	150.00	Sobre	-1.00	1.00	26.89	0.001	0.002	0.001	1,111.76	-29.90	37.37
As 17	410.00	150.00	150.00	Sobre	-1.00	1.00	26.89	0.001	0.002	0.001	2,594.12	-69.76	104.63
As 18	435.00	175.00	150.00	Sobre	-1.00	1.00	26.89	0.002	0.002	0.002	4,076.47	-109.62	191.83
As 19	460.00	200.00	150.00	Sobre	-1.00	1.00	26.89	0.003	0.002	0.002	4,200.00	-112.94	225.88
As 20	485.00	225.00	150.00	Sobre	-1.00	1.00	26.89	0.003	0.002	0.002	4,200.00	-112.94	254.11
As 21	510.00	250.00	150.00	Sobre	-1.00	1.00	26.89	0.004	0.002	0.002	4,200.00	-112.94	282.35
Aportes Totales del Acero												-860.32	1,807.01

Cuadro Resumen			
C =			
	Concreto	Acero	Total
P (ton)	3034.5	-860.32	2,174.18
M (ton m)	6600.0375	1,807.01	8,407.05
Φ	0.821568627		
Φ P (ton)			1786.23658
Φ M (ton m)			6906.964832

Carga y Momentos C=80 cm

Dato	Valor	Unidad
C	80	cm
a	68	cm
Area Comprimida	10200	cm2

Aporte del Concreto

Carga	P (ton)	M (ton m)
Valor	2427.6	5486.376

Aporte del Acero

Material	di	Brazo de Palanca	b	Condicion	Signo P	Signo M	As	es o e's	ey	ε	fs	Aporte P (ton)	Aporte M (ton m)
As 1	10.00	250.00	150.00	Bajo	1.00	1.00	26.89	0.006	0.002	0.002	4,200.00	112.94	282.35
As 2	35.00	225.00	150.00	Bajo	1.00	1.00	26.89	0.005	0.002	0.002	4,200.00	112.94	254.11
As 3	60.00	200.00	150.00	Bajo	1.00	1.00	26.89	0.004	0.002	0.002	4,200.00	112.94	225.88
As 4	85.00	175.00	150.00	Bajo	1.00	1.00	26.89	0.003	0.002	0.002	4,200.00	112.94	197.64
As 5	110.00	150.00	150.00	Sobre	-1.00	-1.00	26.89	0.002	0.002	0.002	4,200.00	-112.94	-169.41
As 6	135.00	125.00	150.00	Sobre	-1.00	-1.00	26.89	0.001	0.002	0.001	2,964.71	-79.72	-99.65
As 7	160.00	100.00	150.00	Sobre	-1.00	-1.00	26.89	0.001	0.002	0.001	1,111.76	-29.90	-29.90
As 8	185.00	75.00	150.00	Sobre	-1.00	-1.00	26.89	0.000	0.002	0.000	741.18	-19.93	-14.95
As 9	210.00	50.00	150.00	Sobre	-1.00	-1.00	26.89	0.001	0.002	0.001	2,594.12	-69.76	-34.88
As 10	235.00	25.00	150.00	Sobre	-1.00	-1.00	26.89	0.002	0.002	0.002	4,200.00	-112.94	-28.23
As 11	260.00	0.00	150.00	Sobre	-1.00	-1.00	26.89	0.003	0.002	0.002	4,200.00	-112.94	0.00
As 12	285.00	-25.00	150.00	Sobre	-1.00	-1.00	26.89	0.004	0.002	0.002	4,200.00	-112.94	28.23
As 13	310.00	-50.00	150.00	Sobre	-1.00	1.00	26.89	0.005	0.002	0.002	4,200.00	-112.94	-56.47
As 14	335.00	75.00	150.00	Sobre	-1.00	1.00	26.89	0.000	0.002	0.000	741.18	-19.93	14.95
As 15	360.00	100.00	150.00	Sobre	-1.00	1.00	26.89	0.001	0.002	0.001	1,111.76	-29.90	29.90
As 16	385.00	125.00	150.00	Sobre	-1.00	1.00	26.89	0.001	0.002	0.001	2,964.71	-79.72	99.65
As 17	410.00	150.00	150.00	Sobre	-1.00	1.00	26.89	0.002	0.002	0.002	4,200.00	-112.94	169.41
As 18	435.00	175.00	150.00	Sobre	-1.00	1.00	26.89	0.003	0.002	0.002	4,200.00	-112.94	197.64
As 19	460.00	200.00	150.00	Sobre	-1.00	1.00	26.89	0.004	0.002	0.002	4,200.00	-112.94	225.88
As 20	485.00	225.00	150.00	Sobre	-1.00	1.00	26.89	0.005	0.002	0.002	4,200.00	-112.94	254.11
As 21	510.00	250.00	150.00	Sobre	-1.00	1.00	26.89	0.006	0.002	0.002	4,200.00	-112.94	282.35
Aportes Totales del Acero												-1,006.48	1,828.60

Cuadro Resumen			
C =			
	Concreto	Acero	Total
P (ton)	2427.6	-1,006.48	1,421.12
M (ton m)	5486.376	1,828.60	7,314.98
Φ			
Φ P (ton)			1279.010806
Φ M (ton m)			6583.477579

Carga y Momentos C=60 cm

Dato	Valor	Unidad
C	60	cm
a	51	cm
Area Comprimida	7650	cm2

Aporte del Concreto

Carga	P (ton)	M (ton m)
Valor	1820.7	4269.5415

Aporte del Acero

Material	di	Brazo de Palanca	b	Condicion	Signo P	Signo M	As	es o e's	ey	ε	fs	Aporte P (ton)	Aporte M (ton m)
As 1	10.00	250.00	150.00	Bajo	1.00	1.00	26.89	0.009</					

As 4	85.00	175.00	150.00	Sobre	-1.00	-1.00	26.89	0.005	0.002	0.002	4,200.00	-112.94	-197.64
As 5	110.00	150.00	150.00	Sobre	-1.00	-1.00	26.89	0.004	0.002	0.002	4,200.00	-112.94	-169.41
As 6	135.00	125.00	150.00	Sobre	-1.00	-1.00	26.89	0.003	0.002	0.002	4,200.00	-112.94	-141.17
As 7	160.00	100.00	150.00	Sobre	-1.00	-1.00	26.89	0.002	0.002	0.002	3,582.35	-96.33	-96.33
As 8	185.00	75.00	150.00	Sobre	-1.00	-1.00	26.89	0.001	0.002	0.001	1,111.76	-29.90	-22.42
As 9	210.00	50.00	150.00	Sobre	-1.00	-1.00	26.89	0.001	0.002	0.001	1,358.82	-36.54	-18.27
As 10	235.00	25.00	150.00	Sobre	-1.00	-1.00	26.89	0.002	0.002	0.002	3,829.41	-102.97	-25.74
As 11	260.00	0.00	150.00	Sobre	-1.00	-1.00	26.89	0.003	0.002	0.002	4,200.00	-112.94	0.00
As 12	285.00	-25.00	150.00	Sobre	-1.00	-1.00	26.89	0.004	0.002	0.002	4,200.00	-112.94	28.23
As 13	310.00	-50.00	150.00	Sobre	-1.00	1.00	26.89	0.005	0.002	0.002	4,200.00	-112.94	-56.47
As 14	335.00	75.00	150.00	Sobre	-1.00	1.00	26.89	0.001	0.002	0.001	1,111.76	-29.90	22.42
As 15	360.00	100.00	150.00	Sobre	-1.00	1.00	26.89	0.002	0.002	0.002	3,582.35	-96.33	96.33
As 16	385.00	125.00	150.00	Sobre	-1.00	1.00	26.89	0.003	0.002	0.002	4,200.00	-112.94	141.17
As 17	410.00	150.00	150.00	Sobre	-1.00	1.00	26.89	0.004	0.002	0.002	4,200.00	-112.94	169.41
As 18	435.00	175.00	150.00	Sobre	-1.00	1.00	26.89	0.005	0.002	0.002	4,200.00	-112.94	197.64
As 19	460.00	200.00	150.00	Sobre	-1.00	1.00	26.89	0.006	0.002	0.002	4,200.00	-112.94	225.88
As 20	485.00	225.00	150.00	Sobre	-1.00	1.00	26.89	0.008	0.002	0.002	4,200.00	-112.94	254.11
As 21	510.00	250.00	150.00	Sobre	-1.00	1.00	26.89	0.009	0.002	0.002	4,200.00	-112.94	282.35
Aportes Totales del Acero												-1,634.28	1,000.66

Cuadro Resumen			
C =			
	Concreto	Acero	Total
P (ton)	1820.7	-1,634.28	186.42
M (ton m)	4269.5415	1,000.66	5,270.21
Φ P (ton)			167.7786353
Φ M (ton m)			4743.184857

Carga y Momentos C=40 cm

Dato	Valor	Unidad
C	40	cm
a	34	cm
Area Comprimida	5100	cm2

Aporte del Concreto

Carga	P (ton)	M (ton m)
Valor	1213.8	2949.534

Aporte del Acero

Material	di	Brazo de Palanca	b	Condicion	Signo P	Signo M	As	es o e's	ey	ε	fs	Aporte P (ton)	Aporte M (ton m)
As 1	10.00	250.00	150.00	Bajo	1.00	1.00	26.89	0.003	0.002	0.002	4,200.00	112.94	282.35
As 2	35.00	225.00	150.00	Bajo	1.00	1.00	26.89	0.003	0.002	0.002	4,200.00	112.94	254.11
As 3	60.00	200.00	150.00	Sobre	-1.00	-1.00	26.89	0.003	0.002	0.002	4,200.00	-112.94	-225.88
As 4	85.00	175.00	150.00	Sobre	-1.00	-1.00	26.89	0.003	0.002	0.002	4,200.00	-112.94	-197.64
As 5	110.00	150.00	150.00	Sobre	-1.00	-1.00	26.89	0.003	0.002	0.002	4,200.00	-112.94	-169.41
As 6	135.00	125.00	150.00	Sobre	-1.00	-1.00	26.89	0.003	0.002	0.002	4,200.00	-112.94	-141.17
As 7	160.00	100.00	150.00	Sobre	-1.00	-1.00	26.89	0.003	0.002	0.002	4,200.00	-112.94	-112.94
As 8	185.00	75.00	150.00	Sobre	-1.00	-1.00	26.89	0.003	0.002	0.002	4,200.00	-112.94	-84.70
As 9	210.00	50.00	150.00	Sobre	-1.00	-1.00	26.89	0.003	0.002	0.002	4,200.00	-112.94	-56.47
As 10	235.00	25.00	150.00	Sobre	-1.00	-1.00	26.89	0.003	0.002	0.002	4,200.00	-112.94	-28.23
As 11	260.00	0.00	150.00	Sobre	-1.00	-1.00	26.89	0.003	0.002	0.002	4,200.00	-112.94	0.00
As 12	285.00	-25.00	150.00	Sobre	-1.00	-1.00	26.89	0.003	0.002	0.002	4,200.00	-112.94	28.23
As 13	310.00	-50.00	150.00	Sobre	-1.00	1.00	26.89	0.003	0.002	0.002	4,200.00	-112.94	-56.47
As 14	335.00	75.00	150.00	Sobre	-1.00	1.00	26.89	0.003	0.002	0.002	4,200.00	-112.94	84.70
As 15	360.00	100.00	150.00	Sobre	-1.00	1.00	26.89	0.003	0.002	0.002	4,200.00	-112.94	112.94
As 16	385.00	125.00	150.00	Sobre	-1.00	1.00	26.89	0.003	0.002	0.002	4,200.00	-112.94	141.17
As 17	410.00	150.00	150.00	Sobre	-1.00	1.00	26.89	0.003	0.002	0.002	4,200.00	-112.94	169.41
As 18	435.00	175.00	150.00	Sobre	-1.00	1.00	26.89	0.003	0.002	0.002	4,200.00	-112.94	197.64
As 19	460.00	200.00	150.00	Sobre	-1.00	1.00	26.89	0.003	0.002	0.002	4,200.00	-112.94	225.88
As 20	485.00	225.00	150.00	Sobre	-1.00	1.00	26.89	0.003	0.002	0.002	4,200.00	-112.94	254.11
As 21	510.00	250.00	150.00	Sobre	-1.00	1.00	26.89	0.003	0.002	0.002	4,200.00	-112.94	282.35
Aportes Totales del Acero												-1,919.95	959.97

Cuadro Resumen			
C =			
	Concreto	Acero	Total
P (ton)	1213.8	-1,919.95	-706.15
M (ton m)	2949.534	959.97	3,909.51
Φ P (ton)			-635.5314
Φ M (ton m)			3518.5563

Carga y Momentos C=20 cm

Dato	Valor	Unidad
C	20	cm
a	17	cm
Area Comprimida	2550	cm2

Aporte del Concreto

Carga	P (ton)	M (ton m)
Valor	606.9	1526.3535

Aporte del Acero

Material	di	Brazo de Palanca	b	Condicion	Signo P	Signo M	As	es o e's	ey	ε	fs	Aporte P (ton)	Aporte M (ton m)
As 1	10.00	250.00	150.00	Bajo	1.00	1.00	26.89	0.032	0.002	0.002	4,200.00	112.94	282.35
As 2	35.00	225.00	150.00	Sobre	-1.00	-1.00	26.89	0.029	0.002	0.002	4,200.00	-112.94	-254.11
As 3	60.00	200.00	150.00	Sobre	-1.00	-1.00	26.89	0.025	0.002	0.002	4,200.00	-112.94	-225.88
As 4	85.00	175.00	150.00	Sobre	-1.00	-1.00	26.89	0.022	0.002	0.002	4,200.00	-112.94	-197.64
As 5	110.00	150.00	150.00	Sobre	-1.00	-1.00	26.89	0.018	0.002	0.002	4,200.00	-112.94	-169.41
As 6	135.00	125.00	150.00	Sobre	-1.00	-1.00	26.89	0.015	0.002	0.002	4,200.00	-112.94	-141.17
As 7	160.00	100.00	150.00	Sobre	-1.00	-1.00	26.89	0.011	0.002	0.002	4,200.00	-112.94	-112.94
As 8	185.00	75.00	150.00	Sobre	-1.00	-1.00	26.89	0.008	0.002	0.002	4,200.00	-112.94	-84.70
As 9	210.00	50.00	150.00	Sobre	-1.00	-1.00	26.89	0.004	0.002	0.002	4,200.00	-112.94	-56.47
As 10	235.00	25.00	150.00	Sobre	-1.00	-1.00	26.89	0.001	0.002	0.001	1,111.76	-29.90	-7.47
As 11	260.00	0.00	150.00	Sobre	-1.00	-1.00	26.89	0.003	0.002	0.002	4,200.00	-112.94	0.00
As 12	285.00	-25.00	150.00	Sobre	-1.00	-1.00	26.89	0.007	0.002	0.002	4,200.00	-112.94	28.23
As 13	310.00	-50.00	150.00	Sobre	-1.00	1.00	26.89	0.010	0.002	0.002	4,200.00	-112.94	-56.47
As 14	335.00	75.00	150.00	Sobre	-1.00	1.00	26.89	0.008	0.002	0.002	4,200.00	-112.94	84.70
As 15	360.00	100.00	150.00	Sobre	-1.00	1.00	26.89	0.011	0.002	0.002	4,200.00	-112.94	112.94
As 16	385.00	125.00	150.00	Sobre	-1.00	1.00	26.89	0.015	0.002	0.002	4,200.00	-112.94	141.17
As 17	410.00	150.00	150.00	Sobre	-1.00	1.00	26.89	0.018	0.002	0.002	4,200.00	-112.94	169.41
As 18	435.00	175.00	150.00	Sobre	-1.00	1.00	26.89	0.022	0.002	0.002	4,200.00	-112.94	197.64
As 19	460.00	200.00	150.00	Sobre	-1.00	1.00	26.89	0.025	0.002	0.002	4,200.00	-112.94	225.88
As 20	485.00	225.00	150.00	Sobre	-1.00	1.00	26.89	0.029	0.002	0.002	4,200.00	-112.94	254.11
As 21	510.00	250.00	150.00	Sobre	-1.00	1.00	26.89	0.032	0.002	0.002	4,200.00	-112.94	282.35
Aportes Totales del Acero												-2,062.78	472.51

Cuadro Resumen			
C =			
	Concreto	Acero	Total
P (ton)	606.9	-2,062.78	-1,455.88
M (ton m)	1526.3535	472.51	1,998.87
Φ P (ton)			-1310.291418
Φ M (ton m)			1798.979546

Carga y Momentos C=10 cm

Dato	Valor	Unidad
C	2	cm
a	1.7	cm
Area Comprimida	255	cm2

Aporte del Concreto

Carga	P (ton)	M (ton m)
Valor	60.69	157.278135

Aporte del Acero

Material	di	Brazo de Palanca	b	Condicion	Signo P	Signo M	As	es o e's	ey	ε	fs	Aporte P (ton)	Aporte M (ton m)
As 1	10.00	250.00	150.00	Sobre	-1.00	-1.00	26.89	0.350	0.002	0.002	4,200.00	-112.94	-282.35
As 2	35.00	225.00	150.00	Sobre	-1.00	-1.00	26.89	0.315	0.002	0.002	4,200.00	-112.94	-254.11
As 3	60.00	200.00	150.00	Sobre	-1.00	-1.00	26.89	0.279	0.002	0.002	4,200.00	-112.94	-225.88
As 4	85.00	175.00	150.00	Sobre	-1.00	-1.00	26.89	0.244	0.002	0.002	4,200.00	-112.94	-197.64
As 5	110.00	150.00	150.00	Sobre	-1.00	-1.00	26.89	0.209	0.002	0.002	4,200.00	-112.94	-169.41
As 6	135.00	125.00	150.00	Sobre	-1.00	-1.00	26.89	0.173	0.002	0.002	4,200.00	-112.94	-141.17
As 7	160.00	100.00	150.00	Sobre	-1.00	-1.00	26.89	0.138	0.002	0.002	4,200.00	-112.94	

As 9	210.00	50.00	150.00	Sobre	-1.00	-1.00	26.89	0.068	0.002	0.002	4,200.00	-112.94	-56.47
As 10	235.00	25.00	150.00	Sobre	-1.00	-1.00	26.89	0.032	0.002	0.002	4,200.00	-112.94	-28.23
As 11	260.00	0.00	150.00	Sobre	-1.00	-1.00	26.89	0.003	0.002	0.002	4,200.00	-112.94	0.00
As 12	285.00	-25.00	150.00	Sobre	-1.00	-1.00	26.89	0.038	0.002	0.002	4,200.00	-112.94	28.23
As 13	310.00	-50.00	150.00	Sobre	-1.00	1.00	26.89	0.074	0.002	0.002	4,200.00	-112.94	-56.47
As 14	335.00	75.00	150.00	Sobre	-1.00	1.00	26.89	0.103	0.002	0.002	4,200.00	-112.94	84.70
As 15	360.00	100.00	150.00	Sobre	-1.00	1.00	26.89	0.138	0.002	0.002	4,200.00	-112.94	112.94
As 16	385.00	125.00	150.00	Sobre	-1.00	1.00	26.89	0.173	0.002	0.002	4,200.00	-112.94	141.17
As 17	410.00	150.00	150.00	Sobre	-1.00	1.00	26.89	0.209	0.002	0.002	4,200.00	-112.94	169.41
As 18	435.00	175.00	150.00	Sobre	-1.00	1.00	26.89	0.244	0.002	0.002	4,200.00	-112.94	197.64
As 19	460.00	200.00	150.00	Sobre	-1.00	1.00	26.89	0.279	0.002	0.002	4,200.00	-112.94	225.88
As 20	485.00	225.00	150.00	Sobre	-1.00	1.00	26.89	0.315	0.002	0.002	4,200.00	-112.94	254.11
As 21	510.00	250.00	150.00	Sobre	-1.00	1.00	26.89	0.350	0.002	0.002	4,200.00	-112.94	282.35
Aportes Totales del Acero												-2,371.70	-112.94

Cuadro Resumen			
C =			
	Concreto	Acero	Total
P (ton)	60.69	-2,371.70	-2,311.01
M (ton m)	157.278135	-112.94	44.34
Φ P (ton)			-2079.9072
Φ M (ton m)			39.9061215

Información Previa		
Dato	Valor	Unidad
Pila	2	-
Fc'	280	kg/cm2
β1	0.85	-
ec	0.003	-
Fy	4200	kg/cm2
Es	2100000	kg/cm2
ey	0.002	-
Recubrimiento	5	cm
b	520	cm
h	150	cm
Ag	78000.00	cm2
As min	780.00	cm2
Ast	780.00	cm2
Ac	77220.00	cm2
Peralte Efectivo d	145	cm
Cent Plast hcp	75	cm

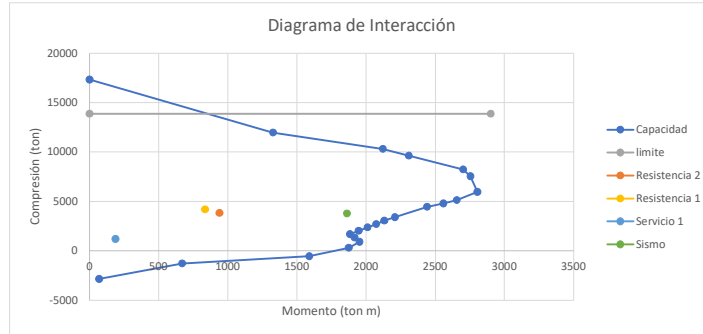

Cuadro Resumen		
C (cm)	P (ton)	M (ton m)
Compresión Pura		
-	17323.488	0
Sobre Cb		
140	11967.09602	1326.094201
130	10308.662	2119.924304
120	9624.888	2308.511767
120	8231.314	2700.591275
100	7547.54	2754.6155
Balanceado		
87	5948.8338	2803.572501
Bajo Cb		
75	5128.305	2655.206531
70	4.786.42	2558.779145
65	4444.531	2440.021561
60	3392.844	2208.25878
55	3050.957	2130.802432
50	2709.07	2072.502919
45	2367.183	2009.795134
40	2025.296	1946.474798
35	1677.444294	1882.541911
30	1353.849509	1915.207894
25	894.0744752	1951.634734
20	303.7044706	1873.44612
15	-545.454	1588.825193
10	-1278.988941	669.83553
5	-2853.7236	70.6049253

Compresión Pura

Dato	Valor	Unidad
Po	21654.36	ton
Pcu	17323.488	ton
Pn max	14075.334	ton
Pcu Max	11260.2672	ton

Dato	Valor	Unidad
Mo	0	ton m
Mcu	0	ton m
Mo Max	0	ton m
Mcu max	0	ton m

Falla Balanceada

Carga y Momentos Balanceados

Dato	Valor	Unidad
C	87.000	cm
a	73.95	cm
Area Comprimida	38454	cm2

Aporte del Concreto

Carga	P (ton)	M (ton m)
Valor	9152.052	3480.067773

Aporte del Acero

Material	di	Brazo de Palanca	b	Condición	Signo P	Signo M	As	es o e's	ey	ε	fs	Aporte P (ton)	Aporte M (ton m)
As 1	12.50	62.50	520.00	Bajo	1.00	1.00	130.00	0.001	0.002	0.001	2,040.37	265.25	165.78
As 2	37.50	37.50	520.00	Bajo	1.00	1.00	130.00	0.002	0.002	0.002	3,744.22	486.75	182.53
As 3	62.50	12.50	520.00	Bajo	1.00	1.00	130.00	0.003	0.002	0.002	4,200.00	546.00	68.25
As 4	87.50	12.50	520.00	Sobre	-1.00	1.00	130.00	0.003	0.002	0.002	4,200.00	-546.00	68.25
As 5	112.50	37.50	520.00	Sobre	-1.00	1.00	130.00	0.002	0.002	0.002	3,744.22	-486.75	182.53
As 6	137.50	62.50	520.00	Sobre	-1.00	1.00	130.00	0.001	0.002	0.001	2,040.37	-265.25	165.78
Aportes Totales del Acero												0.00	833.12

Cuadro Resumen			
C =			
P (ton)	9152.052	0.00	9,152.05
M (ton m)	3480.067773	833.12	4,313.19
Φ P (ton)		5948.8338	
Φ M (ton m)		2803.572501	

Valores Sobre el Cb

Carga y Momentos Cb=100

Dato	Valor	Unidad
C	100	cm
a	85	cm
Area Comprimida	44200	cm2

Aporte del Concreto

Carga	P (ton)	M (ton m)
Valor	10519.6	3418.87

Aporte del Acero

Material	di	Brazo de Palanca	b	Condición	Signo P	Signo M	As	es o e's	ey	ε	fs	Aporte P (ton)	Aporte M (ton m)
As 1	12.50	62.50	520.00	Bajo	1.00	1.00	130.00	0.001	0.002	0.001	2,594.12	337.24	210.77
As 2	37.50	37.50	520.00	Bajo	1.00	1.00	130.00	0.002	0.002	0.002	4,076.47	529.94	198.73
As 3	62.50	12.50	520.00	Bajo	1.00	1.00	130.00	0.003	0.002	0.002	4,200.00	546.00	68.25
As 4	87.50	12.50	520.00	Bajo	1.00	-1.00	130.00	0.003	0.002	0.002	4,200.00	546.00	-68.25
As 5	112.50	37.50	520.00	Sobre	-1.00	1.00	130.00	0.002	0.002	0.002	4,076.47	-529.94	198.73
As 6	137.50	62.50	520.00	Sobre	-1.00	1.00	130.00	0.001	0.002	0.001	2,594.12	-337.24	210.77
Aportes Totales del Acero												1,092.00	819.00

Cuadro Resumen			
C =			
P (ton)	10519.6	1,092.00	11,611.60
M (ton m)	3418.87	819.00	4,237.87
Φ P (ton)		7547.54	
Φ M (ton m)		2754.6155	

Carga y Momentos C=110 cm

Dato	Valor	Unidad
C	110	cm
a	93.5	cm
Area Comprimida	48620	cm2

Aporte del Concreto

Carga	P (ton)	M (ton m)
Valor	11571.56	3268.9657

Aporte del Acero

Material	di	Brazo de Palanca	b	Condición	Signo P	Signo M	As	es o e's	ey	ε	fs	Aporte P (ton)	Aporte M (ton m)
As 1	12.50	62.50	520.00	Bajo	1.00	1.00	130.00	0.001	0.002	0.001	2,931.02	381.03	238.15
As 2	37.50	37.50	520.00	Bajo	1.00	1.00	130.00	0.002	0.002	0.002	4,200.00	546.00	204.75
As 3	62.50	12.50	520.00	Bajo	1.00	1.00	130.00	0.003	0.002	0.002	4,200.00	546.00	68.25
As 4	87.50	12.50	520.00	Bajo	1.00	-1.00	130.00	0.003	0.002	0.002	4,200.00	546.00	-68.25
As 5	112.50	37.50	520.00	Sobre	-1.00	1.00	130.00	0.002	0.002	0.002	4,200.00	-546.00	204.75
As 6	137.50	62.50	520.00	Sobre	-1.00	1.00	130.00	0.001	0.002	0.001	2,931.02	-381.03	238.15
Aportes Totales del Acero												1,092.00	885.79

Cuadro Resumen			
C =			
P (ton)	11571.56	1,092.00	12,663.56
M (ton m)	3268.9657	885.79	4,154.76
Φ P (ton)		8231.314	
Φ M (ton m)		2700.591275	

Carga y Momentos C=120 cm

Dato	Valor	Unidad
C	120	cm
a	102	cm
Area Comprimida	53040	cm2

Aporte del Concreto

Carga	P (ton)	M (ton m)
Valor	12623.52	3029.6448

Aporte del Acero

Material	di	Brazo de Palanca	b	Condicion	Signo P	Signo M	As	es o e's	ey	ε	fs	Aporte P (ton)	Aporte M (ton m)
As 1	12.50	62.50	520.00	Bajo	1.00	1.00	130.00	0.002	0.002	0.002	3,211.76	417.53	260.96
As 2	37.50	37.50	520.00	Bajo	1.00	1.00	130.00	0.002	0.002	0.002	4,200.00	546.00	204.75
As 3	62.50	12.50	520.00	Bajo	1.00	1.00	130.00	0.003	0.002	0.002	4,200.00	546.00	68.25
As 4	87.50	12.50	520.00	Bajo	1.00	-1.00	130.00	0.003	0.002	0.002	4,200.00	546.00	-68.25
As 5	112.50	37.50	520.00	Bajo	1.00	-1.00	130.00	0.002	0.002	0.002	4,200.00	546.00	-204.75
As 6	137.50	62.50	520.00	Sobre	-1.00	1.00	130.00	0.002	0.002	0.002	3,211.76	-417.53	260.96
Aportes Totales del Acero												2,184.00	521.91

Cuadro Resumen			
C =			
	Concreto	Acero	Total
P (ton)	12623.52	2,184.00	14,807.52
M (ton m)	3029.6448	521.91	3,551.56
Φ P (ton)	9624.888		
Φ M (ton m)	2308.511767		

Carga y Momentos C=130 cm

Dato	Valor	Unidad
C	130	cm
a	110.5	cm
Area Comprimida	57460	cm2

Aporte del Concreto

Carga	P (ton)	M (ton m)
Valor	13675.48	2700.9073

Aporte del Acero

Material	di	Brazo de Palanca	b	Condicion	Signo P	Signo M	As	es o e's	ey	ε	fs	Aporte P (ton)	Aporte M (ton m)
As 1	12.50	62.50	520.00	Bajo	1.00	1.00	130.00	0.002	0.002	0.002	3,449.32	448.41	280.26
As 2	37.50	37.50	520.00	Bajo	1.00	1.00	130.00	0.002	0.002	0.002	4,200.00	546.00	204.75
As 3	62.50	12.50	520.00	Bajo	1.00	1.00	130.00	0.003	0.002	0.002	4,200.00	546.00	68.25
As 4	87.50	12.50	520.00	Bajo	1.00	-1.00	130.00	0.003	0.002	0.002	4,200.00	546.00	-68.25
As 5	112.50	37.50	520.00	Bajo	1.00	-1.00	130.00	0.002	0.002	0.002	4,200.00	546.00	-204.75
As 6	137.50	62.50	520.00	Sobre	-1.00	1.00	130.00	0.002	0.002	0.002	3,449.32	-448.41	280.26
Aportes Totales del Acero												2,184.00	560.51

Cuadro Resumen			
C =			
	Concreto	Acero	Total
P (ton)	13675.48	2,184.00	15,859.48
M (ton m)	2700.9073	560.51	3,261.42
Φ P (ton)	10308.662		
Φ M (ton m)	2119.924304		

Carga y Momentos C=145 cm

Dato	Valor	Unidad
C	145	cm
a	123.25	cm
Area Comprimida	64090	cm2

Aporte del Concreto

Carga	P (ton)	M (ton m)
Valor	15253.42	2040.144925

Aporte del Acero

Material	di	Brazo de Palanca	b	Condicion	Signo P	Signo M	As	es o e's	ey	ε	fs	Aporte P (ton)	Aporte M (ton m)
As 1	12.50	62.50	520.00	Bajo	1.00	1.00	130.00	0.002	0.002	0.002	3,744.22	486.75	304.22
As 2	37.50	37.50	520.00	Bajo	1.00	1.00	130.00	0.002	0.002	0.002	4,200.00	546.00	204.75
As 3	62.50	12.50	520.00	Bajo	1.00	1.00	130.00	0.003	0.002	0.002	4,200.00	546.00	68.25
As 4	87.50	12.50	520.00	Bajo	1.00	-1.00	130.00	0.003	0.002	0.002	4,200.00	546.00	-68.25
As 5	112.50	37.50	520.00	Bajo	1.00	-1.00	130.00	0.002	0.002	0.002	4,200.00	546.00	-204.75
As 6	137.50	62.50	520.00	Bajo	1.00	-1.00	130.00	0.002	0.002	0.002	3,744.22	486.75	-304.22
Aportes Totales del Acero												3,157.50	0.00

Cuadro Resumen			
C =			
	Concreto	Acero	Total
P (ton)	15253.42	3,157.50	18,410.92
M (ton m)	2040.144925	0.00	2,040.14
Φ P (ton)	11967.09602		
Φ M (ton m)	1326.094201		

Valores Bajo el Cb

Carga y Momentos C=75 cm

Dato	Valor	Unidad
C	75	cm
a	63.75	cm
Area Comprimida	33150	cm2

Aporte del Concreto

Carga	P (ton)	M (ton m)
Valor	7889.7	3402.433125

Aporte del Acero

Material	di	Brazo de Palanca	b	Condicion	Signo P	Signo M	As	es o e's	ey	ε	fs	Aporte P (ton)	Aporte M (ton m)
As 1	12.50	62.50	520.00	Bajo	1.00	1.00	130.00	0.001	0.002	0.001	1,358.82	176.65	110.40
As 2	37.50	37.50	520.00	Bajo	1.00	1.00	130.00	0.002	0.002	0.002	3,335.29	433.59	162.60
As 3	62.50	12.50	520.00	Bajo	1.00	1.00	130.00	0.003	0.002	0.002	4,200.00	546.00	68.25
As 4	87.50	12.50	520.00	Sobre	-1.00	1.00	130.00	0.003	0.002	0.002	4,200.00	-546.00	68.25
As 5	112.50	37.50	520.00	Sobre	-1.00	1.00	130.00	0.002	0.002	0.002	3,335.29	-433.59	162.60
As 6	137.50	62.50	520.00	Sobre	-1.00	1.00	130.00	0.001	0.002	0.001	1,358.82	-176.65	110.40
Aportes Totales del Acero												0.00	682.50

Cuadro Resumen			
C =			
	Concreto	Acero	Total
P (ton)	7889.7	0.00	7,889.70
M (ton m)	3402.433125	682.50	4,084.93
Φ P (ton)	5128.305		
Φ M (ton m)	2655.206531		

Carga y Momentos C=70 cm

Dato	Valor	Unidad
C	70	cm
a	59.5	cm
Area Comprimida	30940	cm2

Aporte del Concreto

Carga	P (ton)	M (ton m)
-------	---------	-----------

Valor	7363.72	3332.0833
-------	---------	-----------

Aporte del Acero

Material	di	Brazo de Palanca	b	Condicion	Signo P	Signo M	As	es o e's	ey	ε	fs	Aporte P (ton)	Aporte M (ton m)
As 1	12.50	62.50	520.00	Bajo	1.00	1.00	130.00	0.000	0.002	0.000	1,005.88	130.76	81.73
As 2	37.50	37.50	520.00	Bajo	1.00	1.00	130.00	0.001	0.002	0.001	3,123.53	406.06	152.27
As 3	62.50	12.50	520.00	Bajo	1.00	1.00	130.00	0.002	0.002	0.002	4,200.00	546.00	68.25
As 4	87.50	12.50	520.00	Sobre	-1.00	1.00	130.00	0.002	0.002	0.002	4,200.00	-546.00	68.25
As 5	112.50	37.50	520.00	Sobre	-1.00	1.00	130.00	0.001	0.002	0.001	3,123.53	-406.06	152.27
As 6	137.50	62.50	520.00	Sobre	-1.00	1.00	130.00	0.000	0.002	0.000	1,005.88	-130.76	81.73
Aportes Totales del Acero												0.00	604.50

Cuadro Resumen			
C =			
	Concreto	Acero	Total
P (ton)	7363.72	0.00	7,363.72
M (ton m)	3332.0833	604.50	3,936.58
Φ P (ton)			4786.418
Φ M (ton m)			2558.779145

Carga y Momentos C=65 cm

Dato	Valor	Unidad
C	65	cm
a	55.25	cm
Area Comprimida	28730	cm2

Aporte del Concreto

Carga	P (ton)	M (ton m)
Valor	6837.74	3239.379325

Aporte del Acero

Material	di	Brazo de Palanca	b	Condicion	Signo P	Signo M	As	es o e's	ey	ε	fs	Aporte P (ton)	Aporte M (ton m)
As 1	12.50	62.50	520.00	Bajo	1.00	1.00	130.00	0.000	0.002	0.000	598.64	77.82	48.64
As 2	37.50	37.50	520.00	Bajo	1.00	1.00	130.00	0.001	0.002	0.001	2,879.19	374.29	140.36
As 3	62.50	12.50	520.00	Bajo	1.00	1.00	130.00	0.002	0.002	0.002	4,200.00	546.00	68.25
As 4	87.50	12.50	520.00	Sobre	-1.00	1.00	130.00	0.002	0.002	0.002	4,200.00	-546.00	68.25
As 5	112.50	37.50	520.00	Sobre	-1.00	1.00	130.00	0.001	0.002	0.001	2,879.19	-374.29	140.36
As 6	137.50	62.50	520.00	Sobre	-1.00	1.00	130.00	0.000	0.002	0.000	598.64	-77.82	48.64
Aportes Totales del Acero												0.00	514.50

Cuadro Resumen			
C =			
	Concreto	Acero	Total
P (ton)	6837.74	0.00	6,837.74
M (ton m)	3239.379325	514.50	3,753.88
Φ P (ton)			4444.531
Φ M (ton m)			2440.021561

Carga y Momentos C=60 cm

Dato	Valor	Unidad
C	60	cm
a	51	cm
Area Comprimida	26520	cm2

Aporte del Concreto

Carga	P (ton)	M (ton m)
Valor	6311.76	3124.3212

Aporte del Acero

Material	di	Brazo de Palanca	b	Condicion	Signo P	Signo M	As	es o e's	ey	ε	fs	Aporte P (ton)	Aporte M (ton m)
As 1	12.50	62.50	520.00	Bajo	1.00	1.00	130.00	0.000	0.002	0.000	123.53	16.06	10.04
As 2	37.50	37.50	520.00	Bajo	1.00	1.00	130.00	0.001	0.002	0.001	2,594.12	337.24	126.46
As 3	62.50	12.50	520.00	Sobre	-1.00	-1.00	130.00	0.002	0.002	0.002	4,200.00	-546.00	-68.25
As 4	87.50	12.50	520.00	Sobre	-1.00	1.00	130.00	0.002	0.002	0.002	4,200.00	-546.00	68.25
As 5	112.50	37.50	520.00	Sobre	-1.00	1.00	130.00	0.001	0.002	0.001	2,594.12	-337.24	126.46
As 6	137.50	62.50	520.00	Sobre	-1.00	1.00	130.00	0.000	0.002	0.000	123.53	-16.06	10.04
Aportes Totales del Acero												-1,092.00	273.00

Cuadro Resumen			
C =			
	Concreto	Acero	Total
P (ton)	6311.76	-1,092.00	5,219.76
M (ton m)	3124.3212	273.00	3,397.32
Φ P (ton)			3392.844
Φ M (ton m)			2208.25878

Carga y Momentos C=55 cm

Dato	Valor	Unidad
C	55	cm
a	46.75	cm
Area Comprimida	24310	cm2

Aporte del Concreto

Carga	P (ton)	M (ton m)
Valor	5785.78	2986.908925

Aporte del Acero

Material	di	Brazo de Palanca	b	Condicion	Signo P	Signo M	As	es o e's	ey	ε	fs	Aporte P (ton)	Aporte M (ton m)
As 1	12.50	62.50	520.00	Bajo	1.00	1.00	130.00	0.000	0.002	0.000	437.97	56.94	35.58
As 2	37.50	37.50	520.00	Bajo	1.00	1.00	130.00	0.001	0.002	0.001	2,257.22	293.44	110.04
As 3	62.50	12.50	520.00	Sobre	-1.00	-1.00	130.00	0.002	0.002	0.002	4,200.00	-546.00	-68.25
As 4	87.50	12.50	520.00	Sobre	-1.00	1.00	130.00	0.002	0.002	0.002	4,200.00	-546.00	68.25
As 5	112.50	37.50	520.00	Sobre	-1.00	1.00	130.00	0.001	0.002	0.001	2,257.22	-293.44	110.04
As 6	137.50	62.50	520.00	Sobre	-1.00	1.00	130.00	0.000	0.002	0.000	437.97	-56.94	35.58
Aportes Totales del Acero												-1,092.00	291.25

Cuadro Resumen			
C =			
	Concreto	Acero	Total
P (ton)	5785.78	-1,092.00	4,693.78
M (ton m)	2986.908925	291.25	3,278.16
Φ P (ton)			3050.957
Φ M (ton m)			2130.802432

Carga y Momentos C=50 cm

Dato	Valor	Unidad
C	50	cm
a	42.5	cm
Area Comprimida	22100	cm2

Aporte del Concreto

Carga	P (ton)	M (ton m)
Valor	5259.8	2827.1425

Aporte del Acero

Material	di	Brazo de Palanca	b	Condicion	Signo P	Signo M	As	es o e's	ey	ε	fs	Aporte P (ton)	Aporte M (ton m)
As 1	12.50	62.50	520.00	Bajo	1.00	1.00	130.00	0.001	0.002	0.001	1,111.76	144.53	90.33
As 2	37.50	37.50	520.00	Bajo	1.00	1.00	130.00	0.001	0.002	0.001	1,852.94	240.88	90.33
As 3	62.50	12.50	520.00	Sobre	-1.00	-1.00	130.00	0.002	0.002	0.002	4,200.00	-546.00	-68.25
As 4	87.50	12.50	520.00	Sobre	-1.00	1.00	130.00	0.002	0.002	0.002	4,200.00	-546.00	68.25
As 5	112.50	37.50	520.00	Sobre	-1.00	1.00	130.00	0.001	0.002	0.001	1,852.94	-240.88	90.33
As 6	137.50	62.50	520.00	Sobre	-1.00	1.00	130.00	0.001	0.002	0.001	1,111.76	-144.53	90.33
Aportes Totales del Acero												-1,092.00	361.32

Cuadro Resumen			
C =			
	Concreto	Acero	Total
P (ton)	5259.8	-1,092.00	4,167.80

M (ton m)	2827.1425	361.32	3,188.47
Φ P (ton)			2709.07
Φ M (ton m)			2072.502919

Carga y Momentos C=45 cm

Dato	Valor	Unidad
C	45	cm
a	38.25	cm
Area Comprimida	19890	cm2

Aporte del Concreto

Carga	P (ton)	M (ton m)
Valor	4733.82	2645.021925

Aporte del Acero

Material	di	Brazo de Palanca	b	Condicion	Signo P	Signo M	As	es o e's	ey	ε	fs	Aporte P (ton)	Aporte M (ton m)
As 1	12.50	62.50	520.00	Bajo	1.00	1.00	130.00	0.001	0.002	0.001	1,935.29	251.59	157.24
As 2	37.50	37.50	520.00	Bajo	1.00	1.00	130.00	0.001	0.002	0.001	1,358.82	176.65	66.24
As 3	62.50	12.50	520.00	Sobre	-1.00	-1.00	130.00	0.002	0.002	0.002	4,200.00	-546.00	-68.25
As 4	87.50	12.50	520.00	Sobre	-1.00	1.00	130.00	0.002	0.002	0.002	4,200.00	-546.00	68.25
As 5	112.50	37.50	520.00	Sobre	-1.00	1.00	130.00	0.001	0.002	0.001	1,358.82	-176.65	66.24
As 6	137.50	62.50	520.00	Sobre	-1.00	1.00	130.00	0.001	0.002	0.001	1,935.29	-251.59	157.24
Aportes Totales del Acero												-1,092.00	446.97

Cuadro Resumen			
C =			
	Concreto	Acero	Total
P (ton)	4733.82	-1,092.00	3,641.82
M (ton m)	2645.021925	446.97	3,091.99
Φ P (ton)			2367.183
Φ M (ton m)			2009.795134

Carga y Momentos C=40 cm

Dato	Valor	Unidad
C	40	cm
a	34	cm
Area Comprimida	17680	cm2

Aporte del Concreto

Carga	P (ton)	M (ton m)
Valor	4207.84	2440.5472

Aporte del Acero

Material	di	Brazo de Palanca	b	Condicion	Signo P	Signo M	As	es o e's	ey	ε	fs	Aporte P (ton)	Aporte M (ton m)
As 1	12.50	62.50	520.00	Bajo	1.00	1.00	130.00	0.001	0.002	0.001	2,964.71	385.41	240.88
As 2	37.50	37.50	520.00	Bajo	1.00	1.00	130.00	0.000	0.002	0.000	741.18	96.35	36.13
As 3	62.50	12.50	520.00	Sobre	-1.00	-1.00	130.00	0.002	0.002	0.002	4,200.00	-546.00	-68.25
As 4	87.50	12.50	520.00	Sobre	-1.00	1.00	130.00	0.002	0.002	0.002	4,200.00	-546.00	68.25
As 5	112.50	37.50	520.00	Sobre	-1.00	1.00	130.00	0.000	0.002	0.000	741.18	-96.35	36.13
As 6	137.50	62.50	520.00	Sobre	-1.00	1.00	130.00	0.001	0.002	0.001	2,964.71	-385.41	240.88
Aportes Totales del Acero												-1,092.00	554.03

Cuadro Resumen			
C =			
	Concreto	Acero	Total
P (ton)	4207.84	-1,092.00	3,115.84
M (ton m)	2440.5472	554.03	2,994.58
Φ P (ton)			2025.296
Φ M (ton m)			1946.474798

Carga y Momentos C=35 cm

Dato	Valor	Unidad
C	35	cm
a	29.75	cm
Area Comprimida	15470	cm2

Aporte del Concreto

Carga	P (ton)	M (ton m)
Valor	3681.86	2213.718325

Aporte del Acero

Material	di	Brazo de Palanca	b	Condicion	Signo P	Signo M	As	es o e's	ey	ε	fs	Aporte P (ton)	Aporte M (ton m)
As 1	12.50	62.50	520.00	Bajo	1.00	1.00	130.00	0.002	0.002	0.002	4,200.00	546.00	341.25
As 2	37.50	37.50	520.00	Sobre	-1.00	-1.00	130.00	0.000	0.002	0.000	52.94	-6.88	-2.58
As 3	62.50	12.50	520.00	Sobre	-1.00	-1.00	130.00	0.002	0.002	0.002	4,182.35	-543.71	-67.96
As 4	87.50	12.50	520.00	Sobre	-1.00	1.00	130.00	0.002	0.002	0.002	4,182.35	-543.71	67.96
As 5	112.50	37.50	520.00	Sobre	-1.00	1.00	130.00	0.000	0.002	0.000	52.94	-6.88	2.58
As 6	137.50	62.50	520.00	Sobre	-1.00	1.00	130.00	0.0020	0.002	0.002	4,200.00	-546.00	341.25
Aportes Totales del Acero												-1,101.18	682.50

Cuadro Resumen			
C =			
	Concreto	Acero	Total
P (ton)	3681.86	-1,101.18	2,580.68
M (ton m)	2213.718325	682.50	2,896.22
Φ P (ton)			1677.444294
Φ M (ton m)			1882.541911

Carga y Momentos C=30 cm

Dato	Valor	Unidad
C	30	cm
a	25.5	cm
Area Comprimida	13260	cm2

Aporte del Concreto

Carga	P (ton)	M (ton m)
Valor	3155.88	1964.5353

Aporte del Acero

Material	di	Brazo de Palanca	b	Condicion	Signo P	Signo M	As	es o e's	ey	ε	fs	Aporte P (ton)	Aporte M (ton m)
As 1	12.50	62.50	520.00	Bajo	1.00	1.00	130.00	0.003	0.002	0.002	4,200.00	546.00	341.25
As 2	37.50	37.50	520.00	Sobre	-1.00	-1.00	130.00	0.001	0.002	0.001	1,111.76	-144.53	-54.20
As 3	62.50	12.50	520.00	Sobre	-1.00	-1.00	130.00	0.002	0.002	0.002	3,829.41	-497.82	-62.23
As 4	87.50	12.50	520.00	Sobre	-1.00	1.00	130.00	0.002	0.002	0.002	3,829.41	-497.82	62.23
As 5	112.50	37.50	520.00	Sobre	-1.00	1.00	130.00	0.001	0.002	0.001	1,111.76	-144.53	54.20
As 6	137.50	62.50	520.00	Sobre	-1.00	1.00	130.00	0.003	0.002	0.002	4,200.00	-546.00	341.25
Aportes Totales del Acero												-1,284.71	682.50

Cuadro Resumen			
C =			
	Concreto	Acero	Total
P (ton)	3155.88	-1,284.71	1,871.17
M (ton m)	1964.5353	682.50	2,647.04
Φ	0.723529412		
Φ P (ton)			1353.849509
Φ M (ton m)			1915.207894

Carga y Momentos C=25 cm

Dato	Valor	Unidad
C	25	cm
a	21.25	cm
Area Comprimida	11050	cm2

Aporte del Concreto

Carga	P (ton)	M (ton m)
Valor	2629.9	1692.998125

Aporte del Acero

Material	di	Brazo de Palanca	b	Condicion	Signo P	Signo M	As	es o e's	ey	ε	fs	Aporte P (ton)	Aporte M (ton m)
As 1	12.50	62.50	520.00	Bajo	1.00	1.00	130.00	0.004	0.002	0.002	4,200.00	546.00	341.25
As 2	37.50	37.50	520.00	Sobre	-1.00	-1.00	130.00	0.001	0.002	0.001	2,594.12	-337.24	-126.46
As 3	62.50	12.50	520.00	Sobre	-1.00	-1.00	130.00	0.002	0.002	0.002	3,335.29	-433.59	-54.20
As 4	87.50	12.50	520.00	Sobre	-1.00	1.00	130.00	0.002	0.002	0.002	3,335.29	-433.59	54.20
As 5	112.50	37.50	520.00	Sobre	-1.00	1.00	130.00	0.001	0.002	0.001	2,594.12	-337.24	126.46
As 6	137.50	62.50	520.00	Sobre	-1.00	1.00	130.00	0.004	0.002	0.002	4,200.00	-546.00	341.25

Aportes Totales del Acero

-1,541.65 682.50

Cuadro Resumen			
C =			
	Concreto	Acero	Total
P (ton)	2629.9	-1,541.65	1,088.25
M (ton m)	1692.998125	682.50	2,375.50
Φ	0.821568627		
	Φ P (ton)		894.0744752
	Φ M (ton m)		1951.634734

Carga y Momentos C=20 cm

Dato	Valor	Unidad
C	20	cm
a	17	cm
Area Comprimida	8840	cm2

Aporte del Concreto

Carga	P (ton)	M (ton m)
Valor	2103.92	1399.1068

Aporte del Acero

Material	di	Brazo de Palanca	b	Condicion	Signo P	Signo M	As	es o e's	ey	ε	fs	Aporte P (ton)	Aporte M (ton m)
As 1	12.50	62.50	520.00	Bajo	1.00	1.00	130.00	0.006	0.002	0.002	4,200.00	546.00	341.25
As 2	37.50	37.50	520.00	Sobre	-1.00	-1.00	130.00	0.002	0.002	0.002	4,200.00	-546.00	-204.75
As 3	62.50	12.50	520.00	Sobre	-1.00	-1.00	130.00	0.001	0.002	0.001	2,594.12	-337.24	-42.15
As 4	87.50	12.50	520.00	Sobre	-1.00	1.00	130.00	0.001	0.002	0.001	2,594.12	-337.24	42.15
As 5	112.50	37.50	520.00	Sobre	-1.00	1.00	130.00	0.002	0.002	0.002	4,200.00	-546.00	204.75
As 6	137.50	62.50	520.00	Sobre	-1.00	1.00	130.00	0.006	0.002	0.002	4,200.00	-546.00	341.25

Aportes Totales del Acero

-1,766.47 682.50

Cuadro Resumen			
C =			
	Concreto	Acero	Total
P (ton)	2103.92	-1,766.47	337.45
M (ton m)	1399.1068	682.50	2,081.61
	Φ P (ton)		303.7044706
	Φ M (ton m)		1873.44612

Carga y Momentos C=15 cm

Dato	Valor	Unidad
C	15	cm
a	12.75	cm
Area Comprimida	6630	cm2

Aporte del Concreto

Carga	P (ton)	M (ton m)
Valor	1577.94	1082.861325

Aporte del Acero

Material	di	Brazo de Palanca	b	Condicion	Signo P	Signo M	As	es o e's	ey	ε	fs	Aporte P (ton)	Aporte M (ton m)
As 1	12.50	62.50	520.00	Bajo	1.00	1.00	130.00	0.003	0.002	0.002	4,200.00	546.00	341.25
As 2	37.50	37.50	520.00	Sobre	-1.00	-1.00	130.00	0.003	0.002	0.002	4,200.00	-546.00	-204.75
As 3	62.50	12.50	520.00	Sobre	-1.00	-1.00	130.00	0.003	0.002	0.002	4,200.00	-546.00	-68.25
As 4	87.50	12.50	520.00	Sobre	-1.00	1.00	130.00	0.003	0.002	0.002	4,200.00	-546.00	68.25
As 5	112.50	37.50	520.00	Sobre	-1.00	1.00	130.00	0.003	0.002	0.002	4,200.00	-546.00	204.75
As 6	137.50	62.50	520.00	Sobre	-1.00	1.00	130.00	0.003	0.002	0.002	4,200.00	-546.00	341.25

Aportes Totales del Acero

-2,184.00 682.50

Cuadro Resumen			
C =			
	Concreto	Acero	Total
P (ton)	1577.94	-2,184.00	-606.06
M (ton m)	1082.861325	682.50	1,765.36
	Φ P (ton)		-545.454
	Φ M (ton m)		1588.825193

Carga y Momentos C=10 cm

Dato	Valor	Unidad
C	10	cm
a	8.5	cm
Area Comprimida	4420	cm2

Aporte del Concreto

Carga	P (ton)	M (ton m)
Valor	1051.96	744.2617

Aporte del Acero

Material	di	Brazo de Palanca	b	Condicion	Signo P	Signo M	As	es o e's	ey	ε	fs	Aporte P (ton)	Aporte M (ton m)
As 1	12.50	62.50	520.00	Sobre	-1.00	-1.00	130.00	0.015	0.002	0.002	4,200.00	-546.00	-341.25
As 2	37.50	37.50	520.00	Sobre	-1.00	-1.00	130.00	0.008	0.002	0.002	4,200.00	-546.00	-204.75
As 3	62.50	12.50	520.00	Sobre	-1.00	-1.00	130.00	0.001	0.002	0.001	1,111.76	-144.53	-18.07
As 4	87.50	12.50	520.00	Sobre	-1.00	1.00	130.00	0.001	0.002	0.001	1,111.76	-144.53	18.07
As 5	112.50	37.50	520.00	Sobre	-1.00	1.00	130.00	0.008	0.002	0.002	4,200.00	-546.00	204.75
As 6	137.50	62.50	520.00	Sobre	-1.00	1.00	130.00	0.015	0.002	0.002	4,200.00	-546.00	341.25

Aportes Totales del Acero

-2,473.06 0.00

Cuadro Resumen			
C =			
	Concreto	Acero	Total
P (ton)	1051.96	-2,473.06	-1,421.10
M (ton m)	744.2617	0.00	744.26
	Φ P (ton)		-1278.988941
	Φ M (ton m)		669.83553

Carga y Momentos C=1 cm

Dato	Valor	Unidad
C	1	cm
a	0.85	cm
Area Comprimida	442	cm2

Aporte del Concreto

Carga	P (ton)	M (ton m)
Valor	105.196	78.449917

Aporte del Acero

Material	di	Brazo de Palanca	b	Condicion	Signo P	Signo M	As	es o e's	ey	ε	fs	Aporte P (ton)	Aporte M (ton m)
As 1	12.50	62.50	520.00	Sobre	-1.00	-1.00	130.00	0.173	0.002	0.002	4,200.00	-546.00	-341.25
As 2	37.50	37.50	520.00	Sobre	-1.00	-1.00	130.00	0.103	0.002	0.002	4,200.00	-546.00	-204.75
As 3	62.50	12.50	520.00	Sobre	-1.00	-1.00	130.00	0.032	0.002	0.002	4,200.00	-546.00	-68.25
As 4	87.50	12.50	520.00	Sobre	-1.00	1.00	130.00	0.032	0.002	0.002	4,200.00	-546.00	68.25
As 5	112.50	37.50	520.00	Sobre	-1.00	1.00	130.00	0.103	0.002	0.002	4,200.00	-546.00	204.75
As 6	137.50	62.50	520.00	Sobre	-1.00	1.00	130.00	0.173	0.002	0.002	4,200.00	-546.00	341.25

Aportes Totales del Acero

-3,276.00 0.00

Cuadro Resumen		
C =		

	Concreto	Acero	Total
P (ton)	105.196	-3,276.00	-3,170.80
M (ton m)	78.449917	0.00	78.45
Φ P (ton)			-2853.7236
Φ M (ton m)			70.6049253

Apéndice 5

Cortante Pila 1 (Circular)		
Dato	Valor	Unidad
r	260.00	cm
diametro	520.00	cm
Pu	4,752,197.00	kg
Ag	212,371.66	cm ²
Angulo	106.26	
Area de Corte	32,892.73	
f'c	280.00	kg/cm ²
Nu/(6*Ag)	3.73	
0.05*fc	14.00	
menor de	3.73	
fy	4,200.00	kg/cm ²
s	30.00	cm
As min 1 =	12.43	cm ²
As min 2 =	13.00	cm ²
As min =	12.43	cm ²
Vc limite	2,407.12	ton
Vc	1,223.47	ton
Vs =	723.95	ton
V =	1,947.42	ton
Φ	0.75	
ΦVn	1,460.56	
V aplicado	135.00	ton
Vu/ΦVn	0.09	
Cumple		

Cortante Pila 2 (X)		
Dato	Valor	Unidad
b	150.00	cm
d	520.00	cm
f'c	280.00	kg/cm ²
fy	4,200.00	kg/cm ²
Pu	4,120,531.00	kg
Ag	78,000.00	cm ²
Nu/(6*Ag)	8.80	
0.05*fc	14.00	
menor de	8.80	
s	30.00	cm
As min 1 =	12.43	cm ²
As min 2 =	13.00	cm ²
As min =	12.43	cm ²
Vc limite	801.19	ton
Vc	3,297.13	ton
Vs =	723.95	ton
V =	4,021.08	ton
Φ	0.75	
ΦVn	3,015.81	
V aplicado	130.00	ton
Vu/ΦVn	0.04	
Cumple		

Cortante Pila 2 (y)		
Dato	Valor	Unidad
r	520.00	cm
d	150.00	cm
f'c	280.00	kg/cm ²
fy	4,200.00	kg/cm ²
Pu	4,120,531.00	kg
Ag	78,000.00	cm ²
Nu/(6*Ag)	8.80	
0.05*fc	14.00	
menor de	8.80	
s	30.00	cm
As min 1 =	3.59	cm ²
As min 2 =	3.75	cm ²
As min =	3.59	cm ²
Vc limite	9,628.47	ton
Vc	3,297.13	ton
Vs =	60.24	ton
V =	3,357.37	ton
Φ	0.75	
ΦVn	2,518.03	
V aplicado	130.00	ton
Vu/ΦVn	0.052	
Cumple		

Apéndice 6

Información Previa		
Dato	Valor	Unidad
Bastion X	1	-
Fc'	280	kg/cm2
β1	0.85	-
ec	0.003	-
Fy	4200	kg/cm2
Es	2100000	kg/cm2
Ey	0.002	-
Recubrimiento	10	cm
b	110	cm
h	180	cm
Ag	19800.00	cm2
As min	198.00	cm2
Ast	198.00	cm2
Ac	19602.00	cm2
Peralte Efectivo d	170	cm
Cent Plast hcp	90	cm

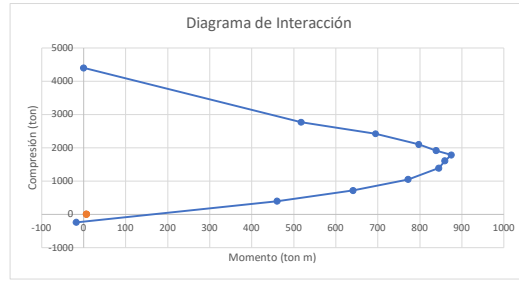

Cuadro Resumen		
C (cm)	P (ton)	M (ton m)
Compresión Pura		
-	4397.5008	0
Sobre Cb		
170	2768.781461	517.2945255
150	2424.125982	694.660648
130	2103.397584	797.4180968
120	1914.315486	838.6978675
110	1787.441903	874.8285049
Balanceado		
102	1606.999386	859.4147318
Bajo Cb		
90	1386.469986	844.8345662
70	1,050.22	771.7997862
50	716.4983872	641.2020368
30	395.7699893	460.336558
5	-237.5027106	-17.27656953

Compresión Pura

Dato	Valor	Unidad
Po	5496.876	ton
Pcu	4397.5008	ton
Pn max	3572.9694	ton
Pcu Max	2858.3752	ton

Dato	Valor	Unidad
Mo	0	ton m
Mcu	0	ton m
Mo Max	0	ton m
Mcu max	0	ton m

Falla Balanceada

Carga y Momentos Balanceados

Dato	Valor	Unidad
C	102	cm
a	86.7	cm
Area Comprimida	9537	cm2

Aporte del Concreto

Carga	P (ton)	M (ton m)
Valor	2269.806	1058.864499

Aporte del Acero

Material	dí	Brazo de Palanca	b	Condición	Signo P	Signo M	As	es o e's	ey	ε	fs	Aporte P (ton)	Aporte M (ton m)
As 1	10.00	80.00	110.00	Bajo	1.00	1.00	55.95	0.001	0.002	0.001	1,649.48	92.29	73.83
As 2	17.50	72.50	110.00	Bajo	1.00	1.00	55.95	0.001	0.002	0.001	2,085.47	116.68	84.59
As 3	30.00	60.00	110.00	Bajo	1.00	1.00	8.60	0.001	0.002	0.001	2,812.11	24.18	14.51
As 4	50.00	40.00	110.00	Bajo	1.00	1.00	8.60	0.002	0.002	0.002	3,974.74	34.18	13.67
As 5	70.00	20.00	110.00	Bajo	1.00	1.00	8.60	0.002	0.002	0.002	4,200.00	36.12	7.22
As 6	90.00	0.00	110.00	Bajo	1.00	1.00	8.60	0.003	0.002	0.002	4,200.00	36.12	0.00
As 7	110.00	20.00	110.00	Sobre	-1.00	1.00	8.60	0.002	0.002	0.002	4,200.00	-36.12	7.22
As 8	130.00	40.00	110.00	Sobre	-1.00	1.00	8.60	0.002	0.002	0.002	3,974.74	-34.18	13.67
As 9	150.00	60.00	110.00	Sobre	-1.00	1.00	8.60	0.001	0.002	0.001	2,812.11	-24.18	14.51
As 10	170.00	80.00	110.00	Sobre	-1.00	1.00	25.82	0.001	0.002	0.001	1,649.48	-42.59	34.07
Aportes Totales del Acero												202.50	263.31

Cuadro Resumen			
C =			
	Concreto	Acero	Total
P (ton)	2269.806	202.50	2,472.31
M (ton m)	1058.864499	263.31	1,322.18
Φ P (ton)	1606.999386		
Φ M (ton m)	859.4147318		

Valores Sobre el Cb

Carga y Momentos Cb=110

Dato	Valor	Unidad
C	110	cm
a	93.5	cm
Area Comprimida	10285	cm2

Aporte del Concreto

Carga	P (ton)	M (ton m)
Valor	2447.83	1058.686475

Aporte del Acero

Material	dí	Brazo de Palanca	b	Condición	Signo P	Signo M	As	es o e's	ey	ε	fs	Aporte P (ton)	Aporte M (ton m)
As 1	10.00	80.00	110.00	Bajo	1.00	1.00	55.95	0.001	0.002	0.001	1,987.70	111.21	88.97
As 2	17.50	72.50	110.00	Bajo	1.00	1.00	55.95	0.001	0.002	0.001	2,391.98	133.83	97.03
As 3	30.00	60.00	110.00	Bajo	1.00	1.00	8.60	0.001	0.002	0.001	3,065.78	26.37	15.82
As 4	50.00	40.00	110.00	Bajo	1.00	1.00	8.60	0.002	0.002	0.002	4,143.85	35.64	14.25
As 5	70.00	20.00	110.00	Bajo	1.00	1.00	8.60	0.002	0.002	0.002	4,200.00	36.12	7.22
As 6	90.00	0.00	110.00	Bajo	1.00	1.00	8.60	0.003	0.002	0.002	4,200.00	36.12	0.00
As 7	110.00	20.00	110.00	Bajo	1.00	-1.00	8.60	0.002	0.002	0.002	4,200.00	36.12	-7.22
As 8	130.00	40.00	110.00	Sobre	-1.00	1.00	8.60	0.002	0.002	0.002	4,143.85	-35.64	14.25
As 9	150.00	60.00	110.00	Sobre	-1.00	1.00	8.60	0.001	0.002	0.001	3,065.78	-26.37	15.82
As 10	170.00	80.00	110.00	Sobre	-1.00	1.00	25.82	0.001	0.002	0.001	1,987.70	-51.32	41.06
Aportes Totales del Acero												302.08	287.20

Cuadro Resumen			
C =			
	Concreto	Acero	Total
P (ton)	2447.83	302.08	2,749.91
M (ton m)	1058.686475	287.20	1,345.89
Φ P (ton)	1787.441903		
Φ M (ton m)	874.8285049		

Carga y Momentos C=120 cm

Dato	Valor	Unidad
C	120	cm
a	102	cm
Area Comprimida	11220	cm2

Aporte del Concreto

Carga	P (ton)	M (ton m)
Valor	2670.36	1041.4404

Aporte del Acero

Material	dí	Brazo de Palanca	b	Condición	Signo P	Signo M	As	es o e's	ey	ε	fs	Aporte P (ton)	Aporte M (ton m)
As 1	10.00	80.00	110.00	Bajo	1.00	1.00	55.95	0.001	0.002	0.001	1,649.48	92.29	73.83
As 2	17.50	72.50	110.00	Bajo	1.00	1.00	55.95	0.001	0.002	0.001	2,085.47	116.68	84.59
As 3	30.00	60.00	110.00	Bajo	1.00	1.00	8.60	0.001	0.002	0.001	2,812.11	24.18	14.51
As 4	50.00	40.00	110.00	Bajo	1.00	1.00	8.60	0.002	0.002	0.002	3,974.74	34.18	13.67
As 5	70.00	20.00	110.00	Bajo	1.00	1.00	8.60	0.002	0.002	0.002	4,200.00	36.12	7.22
As 6	90.00	0.00	110.00	Bajo	1.00	1.00	8.60	0.003	0.002	0.002	4,200.00	36.12	0.00
As 7	110.00	20.00	110.00	Bajo	1.00	-1.00	8.60	0.002	0.002	0.002	4,200.00	36.12	-7.22
As 8	130.00	40.00	110.00	Sobre	-1.00	1.00	8.60	0.002	0.002	0.002	3,974.74	-34.18	13.67
As 9	150.00	60.00	110.00	Sobre	-1.00	1.00	8.60	0.001	0.002	0.001	2,812.11	-24.18	14.51
As 10	170.00	80.00	110.00	Sobre	-1.00	1.00	25.82	0.001	0.002	0.001	1,649.48	-42.59	34.07
Aportes Totales del Acero												274.74	248.86

Cuadro Resumen			
C =			
	Concreto	Acero	Total
P (ton)	2670.36	274.74	2,945.10
M (ton m)	1041.4404	248.86	1,290.30
Φ P (ton)	1914.315486		
Φ M (ton m)	838.6978675		

Carga y Momentos C=130 cm

Dato	Valor	Unidad
C	130	cm
a	110.5	cm
Area Comprimida	12155	cm2

Aporte del Concreto

Carga	P (ton)	M (ton m)
Valor		

Valor	2892.89	1005.279275
-------	---------	-------------

Aporte del Acero													
Material	di	Brazo de Palanca	b	Condicion	Signo P	Signo M	As	es o e's	ey	ε	fs	Aporte P (ton)	Aporte M (ton m)
As 1	10.00	80.00	110.00	Bajo	1.00	1.00	55.95	0.001	0.002	0.001	1,649.48	92.29	73.83
As 2	17.50	72.50	110.00	Bajo	1.00	1.00	55.95	0.001	0.002	0.001	2,085.47	116.68	84.59
As 3	30.00	60.00	110.00	Bajo	1.00	1.00	8.60	0.001	0.002	0.001	2,812.11	24.18	14.51
As 4	50.00	40.00	110.00	Bajo	1.00	1.00	8.60	0.002	0.002	0.002	3,974.74	34.18	13.67
As 5	70.00	20.00	110.00	Bajo	1.00	1.00	8.60	0.002	0.002	0.002	4,200.00	36.12	7.22
As 6	90.00	0.00	110.00	Bajo	1.00	1.00	8.60	0.003	0.002	0.002	4,200.00	36.12	0.00
As 7	110.00	20.00	110.00	Bajo	1.00	-1.00	8.60	0.002	0.002	0.002	4,200.00	36.12	-7.22
As 8	130.00	40.00	110.00	Bajo	1.00	-1.00	8.60	0.002	0.002	0.002	3,974.74	34.18	-13.67
As 9	150.00	60.00	110.00	Sobre	-1.00	1.00	8.60	0.001	0.002	0.001	2,812.11	-24.18	14.51
As 10	170.00	80.00	110.00	Sobre	-1.00	1.00	25.82	0.001	0.002	0.001	1,649.48	-42.59	34.07
Aportes Totales del Acero												343.11	221.52

Cuadro Resumen			
C =			
	Concreto	Acero	Total
P (ton)	2892.89	343.11	3,236.00
M (ton m)	1005.279275	221.52	1,226.80
Φ P (ton)			2103.397584
Φ M (ton m)			797.4180968

Dato	Valor	Unidad
C	150	cm
a	127.5	cm
Area Comprimida	14025	cm2

Aporte del Concreto		
Carga	P (ton)	M (ton m)
Valor	3337.95	876.211875

Aporte del Acero													
Material	di	Brazo de Palanca	b	Condicion	Signo P	Signo M	As	es o e's	ey	ε	fs	Aporte P (ton)	Aporte M (ton m)
As 1	10.00	80.00	110.00	Bajo	1.00	1.00	55.95	0.001	0.002	0.001	1,649.48	92.29	73.83
As 2	17.50	72.50	110.00	Bajo	1.00	1.00	55.95	0.001	0.002	0.001	2,085.47	116.68	84.59
As 3	30.00	60.00	110.00	Bajo	1.00	1.00	8.60	0.001	0.002	0.001	2,812.11	24.18	14.51
As 4	50.00	40.00	110.00	Bajo	1.00	1.00	8.60	0.002	0.002	0.002	3,974.74	34.18	13.67
As 5	70.00	20.00	110.00	Bajo	1.00	1.00	8.60	0.002	0.002	0.002	4,200.00	36.12	7.22
As 6	90.00	0.00	110.00	Bajo	1.00	1.00	8.60	0.003	0.002	0.002	4,200.00	36.12	0.00
As 7	110.00	20.00	110.00	Bajo	1.00	-1.00	8.60	0.002	0.002	0.002	4,200.00	36.12	-7.22
As 8	130.00	40.00	110.00	Bajo	1.00	-1.00	8.60	0.002	0.002	0.002	3,974.74	34.18	-13.67
As 9	150.00	60.00	110.00	Bajo	1.00	-1.00	8.60	0.001	0.002	0.001	2,812.11	24.18	-14.51
As 10	170.00	80.00	110.00	Sobre	-1.00	1.00	25.82	0.001	0.002	0.001	1,649.48	-42.59	34.07
Aportes Totales del Acero												391.47	192.50

Cuadro Resumen			
C =			
	Concreto	Acero	Total
P (ton)	3337.95	391.47	3,729.42
M (ton m)	876.211875	192.50	1,068.71
Φ P (ton)			2424.125982
Φ M (ton m)			694.660648

Dato	Valor	Unidad
C	170	cm
a	144.5	cm
Area Comprimida	15895	cm2

Aporte del Concreto		
Carga	P (ton)	M (ton m)
Valor	3783.01	671.484275

Aporte del Acero													
Material	di	Brazo de Palanca	b	Condicion	Signo P	Signo M	As	es o e's	ey	ε	fs	Aporte P (ton)	Aporte M (ton m)
As 1	10.00	80.00	110.00	Bajo	1.00	1.00	55.95	0.001	0.002	0.001	1,649.48	92.29	73.83
As 2	17.50	72.50	110.00	Bajo	1.00	1.00	55.95	0.001	0.002	0.001	2,085.47	116.68	84.59
As 3	30.00	60.00	110.00	Bajo	1.00	1.00	8.60	0.001	0.002	0.001	2,812.11	24.18	14.51
As 4	50.00	40.00	110.00	Bajo	1.00	1.00	8.60	0.002	0.002	0.002	3,974.74	34.18	13.67
As 5	70.00	20.00	110.00	Bajo	1.00	1.00	8.60	0.002	0.002	0.002	4,200.00	36.12	7.22
As 6	90.00	0.00	110.00	Bajo	1.00	-1.00	8.60	0.003	0.002	0.002	4,200.00	36.12	0.00
As 7	110.00	20.00	110.00	Bajo	1.00	-1.00	8.60	0.002	0.002	0.002	4,200.00	36.12	-7.22
As 8	130.00	40.00	110.00	Bajo	1.00	-1.00	8.60	0.002	0.002	0.002	3,974.74	34.18	-13.67
As 9	150.00	60.00	110.00	Bajo	1.00	-1.00	8.60	0.001	0.002	0.001	2,812.11	24.18	-14.51
As 10	170.00	80.00	110.00	Bajo	1.00	-1.00	25.82	0.001	0.002	0.001	1,649.48	42.59	-34.07
Aportes Totales del Acero												476.65	124.35

Cuadro Resumen			
C =			
	Concreto	Acero	Total
P (ton)	3783.01	476.65	4,259.66
M (ton m)	671.484275	124.35	795.84
Φ P (ton)			2768.781461
Φ M (ton m)			517.2945255

Valores Bajo el Cb

Carga y Momentos C=90 cm		
Dato	Valor	Unidad
C	90	cm
a	76.5	cm
Area Comprimida	8415	cm2

Aporte del Concreto		
Carga	P (ton)	M (ton m)
Valor	2002.77	1036.433475

Aporte del Acero													
Material	di	Brazo de Palanca	b	Condicion	Signo P	Signo M	As	es o e's	ey	ε	fs	Aporte P (ton)	Aporte M (ton m)
As 1	10.00	80.00	110.00	Bajo	1.00	1.00	55.95	0.001	0.002	0.001	1,649.48	92.29	73.83
As 2	17.50	72.50	110.00	Bajo	1.00	1.00	55.95	0.001	0.002	0.001	2,085.47	116.68	84.59
As 3	30.00	60.00	110.00	Bajo	1.00	1.00	8.60	0.001	0.002	0.001	2,812.11	24.18	14.51
As 4	50.00	40.00	110.00	Bajo	1.00	1.00	8.60	0.002	0.002	0.002	3,974.74	34.18	13.67
As 5	70.00	20.00	110.00	Bajo	1.00	1.00	8.60	0.002	0.002	0.002	4,200.00	36.12	7.22
As 6	90.00	0.00	110.00	Sobre	-1.00	-1.00	8.60	0.003	0.002	0.002	4,200.00	-36.12	0.00
As 7	110.00	20.00	110.00	Sobre	-1.00	1.00	8.60	0.002	0.002	0.002	4,200.00	-36.12	7.22
As 8	130.00	40.00	110.00	Sobre	-1.00	1.00	8.60	0.002	0.002	0.002	3,974.74	-34.18	13.67
As 9	150.00	60.00	110.00	Sobre	-1.00	1.00	8.60	0.001	0.002	0.001	2,812.11	-24.18	14.51
As 10	170.00	80.00	110.00	Sobre	-1.00	1.00	25.82	0.001	0.002	0.001	1,649.48	-42.59	34.07
Aportes Totales del Acero												130.26	263.31

Cuadro Resumen			
C =			
	Concreto	Acero	Total
P (ton)	2002.77	130.26	2,133.03
M (ton m)	1036.433475	263.31	1,299.75
Φ P (ton)			1386.469986
Φ M (ton m)			844.8345662

Dato	Valor	Unidad
C	70	cm
a	59.5	cm
Area Comprimida	6545	cm2

Aporte del Concreto		
Carga	P (ton)	M (ton m)
Valor	1557.71	938.520275

Aporte del Acero													
Material	di	Brazo de Palanca	b	Condicion	Signo P	Signo M	As	es o e's	ey	ε	fs	Aporte P (ton)	Aporte M (ton m)
As 1	10.00	80.00	110.00	Bajo	1.00	1.00	55.95	0.001	0.002	0.001	1,649.48	92.29	73.83
As 2	17.50	72.50	110.00	Bajo	1.00	1.00	55.95	0.001	0.002	0.001	2,085.47	116.68	84.59
As 3	30.00	60.00	110.00	Bajo	1.00	1.00	8.60	0.001	0.002	0.001	2,812.11	24.18	14.51
As 4	50.00	40.00	110.00	Bajo	1.00	1.00	8.60	0.002	0.002	0.002	3,974.74	34.18	13.67
As 5	70.00	20.00	110.00	Sobre	-1.00	-1.00	8.60	0.002	0.002	0.002	4,200.00	-36.12	-7.22
As 6	90.00	0.00	110.00	Sobre	-1.00	-1.00	8.60	0.003	0.002	0.002	4,200.00	-36.12	0.00
As 7	110.00	20.00	110.00	Sobre	-1.00	1.00	8.60	0.002	0.002	0.002	4,200.00	-36.12	7.22
As 8	130.00	40.00	110.00	Sobre	-1.00	1.00	8.60	0.002	0.002	0.002	3,974.74	-34.18	13.67
As 9	150.00	60.00	110.00	Sobre	-1.00	1.00	8.60	0.001	0.002	0.001	2,812.11	-24.18	14.51
As 10	170.00	80.00	110.00	Sobre	-1.00	1.00	25.82	0.001	0.002	0.001	1,649.48	-42.59	34.07
Aportes Totales del Acero												58.02	248.86

Cuadro Resumen			
----------------	--	--	--

C =			
	Concreto	Acero	Total
P (ton)	1557.71	58.02	1,615.73
M (ton m)	938.520275	248.86	1,187.38
Φ P (ton)			1050.224986
Φ M (ton m)			771.7997862

Carga y Momentos C=50 cm

Dato	Valor	Unidad
C	50	cm
a	42.5	cm
Area Comprimida	4675	cm2

Aporte del Concreto

Carga	P (ton)	M (ton m)
Valor	1112.65	764.946875

Aporte del Acero

Material	di	Brazo de Palanca	b	Condicion	Signo P	Signo M	As	es o e's	ey	ε	fs	Aporte P (ton)	Aporte M (ton m)
As 1	10.00	80.00	110.00	Bajo	1.00	1.00	55.95	0.001	0.002	0.001	1,649.48	92.29	73.83
As 2	17.50	72.50	110.00	Bajo	1.00	1.00	55.95	0.001	0.002	0.001	2,085.47	116.68	84.59
As 3	30.00	60.00	110.00	Bajo	1.00	1.00	8.60	0.001	0.002	0.001	2,812.11	24.18	14.51
As 4	50.00	40.00	110.00	Sobre	-1.00	-1.00	8.60	0.002	0.002	0.002	3,974.74	-34.18	-13.67
As 5	70.00	20.00	110.00	Sobre	-1.00	-1.00	8.60	0.002	0.002	0.002	4,200.00	-36.12	-7.22
As 6	90.00	0.00	110.00	Sobre	-1.00	-1.00	8.60	0.003	0.002	0.002	4,200.00	-36.12	0.00
As 7	110.00	20.00	110.00	Sobre	-1.00	1.00	8.60	0.002	0.002	0.002	4,200.00	-36.12	7.22
As 8	130.00	40.00	110.00	Sobre	-1.00	1.00	8.60	0.002	0.002	0.002	3,974.74	-34.18	13.67
As 9	150.00	60.00	110.00	Sobre	-1.00	1.00	8.60	0.001	0.002	0.001	2,812.11	-24.18	14.51
As 10	170.00	80.00	110.00	Sobre	-1.00	1.00	25.82	0.001	0.002	0.001	1,649.48	-42.59	34.07
Aportes Totales del Acero												-10.34	221.52

Cuadro Resumen			
C =			
	Concreto	Acero	Total
P (ton)	1112.65	-10.34	1,102.31
M (ton m)	764.946875	221.52	986.46
Φ P (ton)			716.4983872
Φ M (ton m)			641.2020368

Carga y Momentos C=30 cm

Dato	Valor	Unidad
C	30	cm
a	25.5	cm
Area Comprimida	2805	cm2

Aporte del Concreto

Carga	P (ton)	M (ton m)
Valor	667.59	515.713275

Aporte del Acero

Material	di	Brazo de Palanca	b	Condicion	Signo P	Signo M	As	es o e's	ey	ε	fs	Aporte P (ton)	Aporte M (ton m)
As 1	10.00	80.00	110.00	Bajo	1.00	1.00	55.95	0.001	0.002	0.001	1,649.48	92.29	73.83
As 2	17.50	72.50	110.00	Bajo	1.00	1.00	55.95	0.001	0.002	0.001	2,085.47	116.68	84.59
As 3	30.00	60.00	110.00	Sobre	-1.00	-1.00	8.60	0.001	0.002	0.001	2,812.11	-24.18	-14.51
As 4	50.00	40.00	110.00	Sobre	-1.00	-1.00	8.60	0.002	0.002	0.002	3,974.74	-34.18	-13.67
As 5	70.00	20.00	110.00	Sobre	-1.00	-1.00	8.60	0.002	0.002	0.002	4,200.00	-36.12	-7.22
As 6	90.00	0.00	110.00	Sobre	-1.00	-1.00	8.60	0.003	0.002	0.002	4,200.00	-36.12	0.00
As 7	110.00	20.00	110.00	Sobre	-1.00	1.00	8.60	0.002	0.002	0.002	4,200.00	-36.12	7.22
As 8	130.00	40.00	110.00	Sobre	-1.00	1.00	8.60	0.002	0.002	0.002	3,974.74	-34.18	13.67
As 9	150.00	60.00	110.00	Sobre	-1.00	1.00	8.60	0.001	0.002	0.001	2,812.11	-24.18	14.51
As 10	170.00	80.00	110.00	Sobre	-1.00	1.00	25.82	0.001	0.002	0.001	1,649.48	-42.59	34.07
Aportes Totales del Acero												-58.71	192.50

Cuadro Resumen			
C =			
	Concreto	Acero	Total
P (ton)	667.59	-58.71	608.88
M (ton m)	515.713275	192.50	708.21
Φ P (ton)			395.7699893
Φ M (ton m)			460.336558

Carga y Momentos C=5 cm

Dato	Valor	Unidad
C	5	cm
a	4.25	cm
Area Comprimida	467.5	cm2

Aporte del Concreto

Carga	P (ton)	M (ton m)
Valor	111.265	97.77411875

Aporte del Acero

Material	di	Brazo de Palanca	b	Condicion	Signo P	Signo M	As	es o e's	ey	ε	fs	Aporte P (ton)	Aporte M (ton m)
As 1	10.00	80.00	110.00	Sobre	-1.00	-1.00	55.95	0.001	0.002	0.001	1,649.48	-92.29	-73.83
As 2	17.50	72.50	110.00	Sobre	-1.00	-1.00	55.95	0.001	0.002	0.001	2,085.47	-116.68	-84.59
As 3	30.00	60.00	110.00	Sobre	-1.00	-1.00	8.60	0.001	0.002	0.001	2,812.11	-24.18	-14.51
As 4	50.00	40.00	110.00	Sobre	-1.00	-1.00	8.60	0.002	0.002	0.002	3,974.74	-34.18	-13.67
As 5	70.00	20.00	110.00	Sobre	-1.00	-1.00	8.60	0.002	0.002	0.002	4,200.00	-36.12	-7.22
As 6	90.00	0.00	110.00	Sobre	-1.00	-1.00	8.60	0.003	0.002	0.002	4,200.00	-36.12	0.00
As 7	110.00	20.00	110.00	Sobre	-1.00	1.00	8.60	0.002	0.002	0.002	4,200.00	-36.12	7.22
As 8	130.00	40.00	110.00	Sobre	-1.00	1.00	8.60	0.002	0.002	0.002	3,974.74	-34.18	13.67
As 9	150.00	60.00	110.00	Sobre	-1.00	1.00	8.60	0.001	0.002	0.001	2,812.11	-24.18	14.51
As 10	170.00	80.00	110.00	Sobre	-1.00	1.00	25.82	0.001	0.002	0.001	1,649.48	-42.59	34.07
Aportes Totales del Acero												-476.65	-124.35

Cuadro Resumen			
C =			
	Concreto	Acero	Total
P (ton)	111.265	-476.65	-365.39
M (ton m)	97.77411875	-124.35	-26.58
Φ P (ton)			-237.5027106
Φ M (ton m)			-17.27656953

Información Previa		
Dato	Valor	Unidad
Bastion X	1	-
Fc'	280	kg/cm2
β1	0.85	-
ec	0.003	-
Fy	4200	kg/cm2
Es	2100000	kg/cm2
Ey	0.002	-
Recubrimiento	10	cm
b	180	cm
h	110	cm
Ag	19800.00	cm2
As min	198.00	cm2
Ast	198.00	cm2
Ac	19602.00	cm2
Peralte Efectivo d	100	cm
Cent Plast hcp	55	cm

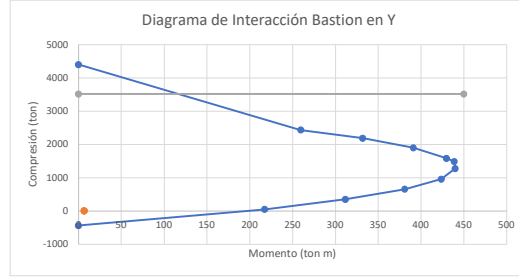

Cuadro Resumen		
C (cm)	P (ton)	M (ton m)
Compresión Pura		
-	4397.5008	0
Sobre Cb		
100	2434.806706	259.5509441
90	2189.8695	331.8035055
80	1899.145376	391.0678751
70	1582.874876	429.7516338
61	1488.042521	438.8226443
Balanceado		
60	1277.524376	439.9744601
Bajo Cb		
50	961.2538765	423.7019538
40	655.90	380.9341151
30	350.5528765	311.6709438
20	50.39	217.3120629
1.21	-438.5153634	0.00593665

Compresión Pura

Dato	Valor	Unidad
Po	5496.876	ton
Pcu	4397.5008	ton
Pn max	3572.9694	ton
Pcu Max	2858.3752	ton

Dato	Valor	Unidad
Mo	0	ton m
Mcu	0	ton m
Mo Max	0	ton m
Mcu max	0	ton m

Falla Balanceada

Carga y Momentos Balanceados

Dato	Valor	Unidad
C	60	cm
a	51	cm
Area Comprimida	7650	cm2

Aporte del Concreto

Carga	P (ton)	M (ton m)
Valor	1820.7	537.1065

Aporte del Acero

Material	d1	Brazo de Palanca	b	Condicion	Signo P	Signo M	As	es o e's	ey	ε	fs	Aporte P (ton)	Aporte M (ton m)
As 1	10.00	45.00	110.00	Bajo	1.00	1.00	19.80	0.001	0.002	0.001	1,852.94	36.69	16.51
As 2	19.00	36.00	110.00	Bajo	1.00	1.00	19.80	0.001	0.002	0.001	2,742.35	54.30	19.55
As 3	28.00	27.00	110.00	Bajo	1.00	1.00	21.80	0.002	0.002	0.002	3,631.76	79.17	21.38
As 4	37.00	18.00	110.00	Bajo	1.00	1.00	19.80	0.002	0.002	0.002	4,200.00	83.16	14.97
As 5	46.00	9.00	110.00	Bajo	1.00	1.00	19.80	0.003	0.002	0.002	4,200.00	83.16	7.48
As 6	55.00	0.00	110.00	Bajo	1.00	1.00	21.80	0.003	0.002	0.002	4,200.00	91.56	0.00
As 7	64.00	9.00	110.00	Sobre	-1.00	1.00	19.80	0.003	0.002	0.002	4,200.00	-83.16	7.48
As 8	73.00	18.00	110.00	Sobre	-1.00	1.00	21.80	0.002	0.002	0.002	4,200.00	-91.56	16.48
As 9	82.00	27.00	110.00	Sobre	-1.00	1.00	19.80	0.002	0.002	0.002	3,631.76	-79.17	19.42
As 10	100.00	45.00	110.00	Sobre	-1.00	1.00	19.80	0.001	0.002	0.001	1,852.94	-36.69	16.51
Aportes Totales del Acero												144.72	139.78

Cuadro Resumen			
C =			
	Concreto	Acero	Total
P (ton)	1820.7	144.72	1,965.42
M (ton m)	537.1065	139.78	676.88
Φ P (ton)	1277.524376		
Φ M (ton m)	439.9744601		

Valores Sobre el Cb

Carga y Momentos Cb=65

Dato	Valor	Unidad
C	65	cm
a	55.25	cm
Area Comprimida	8287.5	cm2

Aporte del Concreto

Carga	P (ton)	M (ton m)
Valor	1972.425	539.9513438

Aporte del Acero

Material	d1	Brazo de Palanca	b	Condicion	Signo P	Signo M	As	es o e's	ey	ε	fs	Aporte P (ton)	Aporte M (ton m)
As 1	10.00	45.00	110.00	Bajo	1.00	1.00	19.80	0.001	0.002	0.001	2,195.02	43.46	19.56
As 2	19.00	36.00	110.00	Bajo	1.00	1.00	19.80	0.001	0.002	0.001	3,016.02	59.72	21.50
As 3	28.00	27.00	110.00	Bajo	1.00	1.00	21.80	0.002	0.002	0.002	3,837.01	83.65	22.58
As 4	37.00	18.00	110.00	Bajo	1.00	1.00	19.80	0.002	0.002	0.002	4,200.00	83.16	14.97
As 5	46.00	9.00	110.00	Bajo	1.00	1.00	19.80	0.003	0.002	0.002	4,200.00	83.16	7.48
As 6	55.00	0.00	110.00	Bajo	1.00	1.00	21.80	0.003	0.002	0.002	4,200.00	91.56	0.00
As 7	64.00	9.00	110.00	Bajo	1.00	-1.00	19.80	0.003	0.002	0.002	4,200.00	83.16	-7.48
As 8	73.00	18.00	110.00	Sobre	-1.00	1.00	21.80	0.002	0.002	0.002	4,200.00	-91.56	16.48
As 9	82.00	27.00	110.00	Sobre	-1.00	1.00	19.80	0.002	0.002	0.002	3,837.01	-79.17	20.51
As 10	100.00	45.00	110.00	Sobre	-1.00	1.00	19.80	0.001	0.002	0.001	2,195.02	-43.46	19.56
Aportes Totales del Acero												316.87	135.16

Cuadro Resumen			
C =			
	Concreto	Acero	Total
P (ton)	1972.425	316.87	2,289.30
M (ton m)	539.9513438	135.16	675.11
Φ P (ton)	1488.042521		
Φ M (ton m)	438.8226443		

Carga y Momentos C=70 cm

Dato	Valor	Unidad
C	70	cm
a	59.5	cm
Area Comprimida	8925	cm2

Aporte del Concreto

Carga	P (ton)	M (ton m)
Valor	2124.15	536.347875

Aporte del Acero

Material	d1	Brazo de Palanca	b	Condicion	Signo P	Signo M	As	es o e's	ey	ε	fs	Aporte P (ton)	Aporte M (ton m)
As 1	10.00	45.00	110.00	Bajo	1.00	1.00	19.80	0.001	0.002	0.001	1,852.94	36.69	16.51
As 2	19.00	36.00	110.00	Bajo	1.00	1.00	19.80	0.001	0.002	0.001	2,742.35	54.30	19.55
As 3	28.00	27.00	110.00	Bajo	1.00	1.00	21.80	0.002	0.002	0.002	3,631.76	79.17	21.38
As 4	37.00	18.00	110.00	Bajo	1.00	1.00	19.80	0.002	0.002	0.002	4,200.00	83.16	14.97
As 5	46.00	9.00	110.00	Bajo	1.00	1.00	19.80	0.003	0.002	0.002	4,200.00	83.16	7.48
As 6	55.00	0.00	110.00	Bajo	1.00	1.00	21.80	0.003	0.002	0.002	4,200.00	91.56	0.00
As 7	64.00	9.00	110.00	Bajo	1.00	-1.00	19.80	0.003	0.002	0.002	4,200.00	83.16	-7.48
As 8	73.00	18.00	110.00	Sobre	-1.00	1.00	21.80	0.002	0.002	0.002	4,200.00	-91.56	16.48
As 9	82.00	27.00	110.00	Sobre	-1.00	1.00	19.80	0.002	0.002	0.002	3,631.76	-79.17	19.42
As 10	100.00	45.00	110.00	Sobre	-1.00	1.00	19.80	0.001	0.002	0.001	1,852.94	-36.69	16.51
Aportes Totales del Acero												311.04	124.81

Cuadro Resumen			
C =			
	Concreto	Acero	Total
P (ton)	2124.15	311.04	2,435.19
M (ton m)	536.347875	124.81	661.16
Φ P (ton)	1582.874876		
Φ M (ton m)	429.7516338		

Carga y Momentos C=80 cm

Dato	Valor	Unidad
C	80	cm
a	68	cm
Area Comprimida	10200	cm2

Aporte del Concreto

Carga	P (ton)	M (ton m)
Valor	2124.15	536.347875

Valor	2427.6	509.796
-------	--------	---------

Aporte del Acero

Material	di	Brazo de Palanca	b	Condicion	Signo P	Signo M	As	es o e's	ey	ε	fs	Aporte P (ton)	Aporte M (ton m)
As 1	10.00	45.00	110.00	Bajo	1.00	1.00	19.80	0.001	0.002	0.001	1,852.94	36.69	16.51
As 2	19.00	36.00	110.00	Bajo	1.00	1.00	19.80	0.001	0.002	0.001	2,742.35	54.30	19.55
As 3	28.00	27.00	110.00	Bajo	1.00	1.00	21.80	0.002	0.002	0.002	3,631.76	79.17	21.38
As 4	37.00	18.00	110.00	Bajo	1.00	1.00	19.80	0.002	0.002	0.002	4,200.00	83.16	14.97
As 5	46.00	9.00	110.00	Bajo	1.00	1.00	19.80	0.003	0.002	0.002	4,200.00	83.16	7.48
As 6	55.00	0.00	110.00	Bajo	1.00	1.00	21.80	0.003	0.002	0.002	4,200.00	91.56	0.00
As 7	64.00	9.00	110.00	Bajo	1.00	-1.00	19.80	0.003	0.002	0.002	4,200.00	83.16	-7.48
As 8	73.00	18.00	110.00	Bajo	1.00	-1.00	21.80	0.002	0.002	0.002	4,200.00	91.56	-16.48
As 9	82.00	27.00	110.00	Sobre	-1.00	1.00	19.80	0.002	0.002	0.002	3,631.76	-71.91	19.42
As 10	100.00	45.00	110.00	Sobre	-1.00	1.00	19.80	0.001	0.002	0.001	1,852.94	-36.69	16.51
Aportes Totales del Acero												494.16	91.85

Cuadro Resumen			
C =			
	Concreto	Acero	Total
P (ton)	2427.6	494.16	2,921.76
M (ton m)	509.796	91.85	601.64
Φ P (ton)	1899.145376		
Φ M (ton m)	391.0678751		

Carga y Momentos C=90 cm

Dato	Valor	Unidad
C	90	cm
a	76.5	cm
Area Comprimida	11475	cm2

Aporte del Concreto

Carga	P (ton)	M (ton m)
Valor	2731.05	457.450875

Aporte del Acero

Material	di	Brazo de Palanca	b	Condicion	Signo P	Signo M	As	es o e's	ey	ε	fs	Aporte P (ton)	Aporte M (ton m)
As 1	10.00	45.00	110.00	Bajo	1.00	1.00	19.80	0.001	0.002	0.001	1,852.94	36.69	16.51
As 2	19.00	36.00	110.00	Bajo	1.00	1.00	19.80	0.001	0.002	0.001	2,742.35	54.30	19.55
As 3	28.00	27.00	110.00	Bajo	1.00	1.00	21.80	0.002	0.002	0.002	3,631.76	79.17	21.38
As 4	37.00	18.00	110.00	Bajo	1.00	1.00	19.80	0.002	0.002	0.002	4,200.00	83.16	14.97
As 5	46.00	9.00	110.00	Bajo	1.00	1.00	19.80	0.003	0.002	0.002	4,200.00	83.16	7.48
As 6	55.00	0.00	110.00	Bajo	1.00	1.00	21.80	0.003	0.002	0.002	4,200.00	91.56	0.00
As 7	64.00	9.00	110.00	Bajo	1.00	-1.00	19.80	0.003	0.002	0.002	4,200.00	83.16	-7.48
As 8	73.00	18.00	110.00	Bajo	1.00	-1.00	21.80	0.002	0.002	0.002	4,200.00	91.56	-16.48
As 9	82.00	27.00	110.00	Bajo	1.00	-1.00	19.80	0.002	0.002	0.002	3,631.76	71.91	-19.42
As 10	100.00	45.00	110.00	Sobre	-1.00	1.00	19.80	0.001	0.002	0.001	1,852.94	-36.69	16.51
Aportes Totales del Acero												637.98	53.02

Cuadro Resumen			
C =			
	Concreto	Acero	Total
P (ton)	2731.05	637.98	3,369.03
M (ton m)	457.450875	53.02	510.47
Φ P (ton)	2189.8695		
Φ M (ton m)	331.8035055		

Carga y Momentos C=100 cm

Dato	Valor	Unidad
C	100	cm
a	85	cm
Area Comprimida	12750	cm2

Aporte del Concreto

Carga	P (ton)	M (ton m)
Valor	3034.5	379.3125

Aporte del Acero

Material	di	Brazo de Palanca	b	Condicion	Signo P	Signo M	As	es o e's	ey	ε	fs	Aporte P (ton)	Aporte M (ton m)
As 1	10.00	45.00	110.00	Bajo	1.00	1.00	19.80	0.001	0.002	0.001	1,852.94	36.69	16.51
As 2	19.00	36.00	110.00	Bajo	1.00	1.00	19.80	0.001	0.002	0.001	2,742.35	54.30	19.55
As 3	28.00	27.00	110.00	Bajo	1.00	1.00	21.80	0.002	0.002	0.002	3,631.76	79.17	21.38
As 4	37.00	18.00	110.00	Bajo	1.00	1.00	19.80	0.002	0.002	0.002	4,200.00	83.16	14.97
As 5	46.00	9.00	110.00	Bajo	1.00	1.00	19.80	0.003	0.002	0.002	4,200.00	83.16	7.48
As 6	55.00	0.00	110.00	Bajo	1.00	1.00	21.80	0.003	0.002	0.002	4,200.00	91.56	0.00
As 7	64.00	9.00	110.00	Bajo	1.00	-1.00	19.80	0.003	0.002	0.002	4,200.00	83.16	-7.48
As 8	73.00	18.00	110.00	Bajo	1.00	-1.00	21.80	0.002	0.002	0.002	4,200.00	91.56	-16.48
As 9	82.00	27.00	110.00	Bajo	1.00	-1.00	19.80	0.002	0.002	0.002	3,631.76	71.91	-19.42
As 10	100.00	45.00	110.00	Bajo	1.00	-1.00	19.80	0.001	0.002	0.001	1,852.94	36.69	-16.51
Aportes Totales del Acero												711.36	20.00

Cuadro Resumen			
C =			
	Concreto	Acero	Total
P (ton)	3034.5	711.36	3,745.86
M (ton m)	379.3125	20.00	399.31
Φ P (ton)	2434.806706		
Φ M (ton m)	259.5509441		

Valores Bajo el Cb

Carga y Momentos C=50 cm

Dato	Valor	Unidad
C	50	cm
a	42.5	cm
Area Comprimida	6375	cm2

Aporte del Concreto

Carga	P (ton)	M (ton m)
Valor	1517.25	512.071875

Aporte del Acero

Material	di	Brazo de Palanca	b	Condicion	Signo P	Signo M	As	es o e's	ey	ε	fs	Aporte P (ton)	Aporte M (ton m)
As 1	10.00	45.00	110.00	Bajo	1.00	1.00	19.80	0.001	0.002	0.001	1,852.94	36.69	16.51
As 2	19.00	36.00	110.00	Bajo	1.00	1.00	19.80	0.001	0.002	0.001	2,742.35	54.30	19.55
As 3	28.00	27.00	110.00	Bajo	1.00	1.00	21.80	0.002	0.002	0.002	3,631.76	79.17	21.38
As 4	37.00	18.00	110.00	Bajo	1.00	1.00	19.80	0.002	0.002	0.002	4,200.00	83.16	14.97
As 5	46.00	9.00	110.00	Bajo	1.00	1.00	19.80	0.003	0.002	0.002	4,200.00	83.16	7.48
As 6	55.00	0.00	110.00	Sobre	-1.00	-1.00	21.80	0.003	0.002	0.002	4,200.00	-91.56	0.00
As 7	64.00	9.00	110.00	Sobre	-1.00	1.00	19.80	0.003	0.002	0.002	4,200.00	-83.16	7.48
As 8	73.00	18.00	110.00	Sobre	-1.00	1.00	21.80	0.002	0.002	0.002	4,200.00	-91.56	16.48
As 9	82.00	27.00	110.00	Sobre	-1.00	1.00	19.80	0.002	0.002	0.002	3,631.76	-71.91	19.42
As 10	100.00	45.00	110.00	Sobre	-1.00	1.00	19.80	0.001	0.002	0.001	1,852.94	-36.69	16.51
Aportes Totales del Acero												-38.40	139.78

Cuadro Resumen			
C =			
	Concreto	Acero	Total
P (ton)	1517.25	-38.40	1,478.85
M (ton m)	512.071875	139.78	651.85
Φ P (ton)	961.2538765		
Φ M (ton m)	423.7019538		

Carga y Momentos C=40 cm

Dato	Valor	Unidad
C	40	cm
a	34	cm
Area Comprimida	5100	cm2

Aporte del Concreto

Carga	P (ton)	M (ton m)
Valor	1213.8	461.244

Aporte del Acero

Material	di	Brazo de Palanca	b	Condicion	Signo P	Signo M	As	es o e's	ey	ε	fs	Aporte P (ton)	Aporte M (ton m)
As 1	10.00	45.00	110.00	Bajo	1.00	1.00	19.80	0.001	0.002	0.001	1,852.94	36.69	16.51
As 2	19.00	36.00	110.00	Bajo	1.00	1.00	19.80	0.001	0.002	0.001	2,742.35	54.30	19.55
As 3	28.00	27.00	110.00	Bajo	1.00	1.00	21.80	0.002	0.002	0.002	3,631.76	79.17	21.38
As 4	37.00	18.00	110.00	Bajo	1.00	1.00	19.80	0.002	0.002	0.002	4,200.00	83.16	14.97
As 5	46.00	9.00	110.00	Sobre	-1.00	-1.00	19.80	0.003	0.002	0.002	4,200.00	-83.16	-7.48
As 6	55.00	0.00	110.00	Sobre	-1.00	-1.00	21.80	0.003	0.002	0.002	4,200.00	-91.56	0.00
As 7	64.00	9.00	110.00	Sobre	-1.00	1.00	19.80	0.003	0.002	0.002	4,200.00	-83.16	7.48
As 8	73.00	18.00	110.00	Sobre	-1.00	1.00	21.80	0.002	0.002	0.002	4,200.00	-91.56	16.48
As 9	82.00	27.00	110.00	Sobre	-1.00	1.00	19.80	0.002	0.002	0.002	3,631.76	-71.91	19.42
As 10	100.00	45.00	110.00	Sobre	-1.00	1.00	19.80	0.001	0.002	0.001	1,852.94	-36.69	16.51
Aportes Totales del Acero												-204.72	124.81

Cuadro Resumen

C =			
	Concreto	Acero	Total
P (ton)	1213.8	-204.72	1,009.08
M (ton m)	461.244	124.81	586.05
Φ P (ton)			655.9033765
Φ M (ton m)			380.9341151

Carga y Momentos C=30 cm

Dato	Valor	Unidad
C	30	cm
a	25.5	cm
Area Comprimida	3825	cm2

Aporte del Concreto

Carga	P (ton)	M (ton m)
Valor	910.35	384.622875

Aporte del Acero

Material	di	Brazo de Palanca	b	Condicion	Signo P	Signo M	As	es o e's	ey	ε	fs	Aporte P (ton)	Aporte M (ton m)
As 1	10.00	45.00	110.00	Bajo	1.00	1.00	19.80	0.001	0.002	0.001	1,852.94	36.69	16.51
As 2	19.00	36.00	110.00	Bajo	1.00	1.00	19.80	0.001	0.002	0.001	2,742.35	54.30	19.55
As 3	28.00	27.00	110.00	Bajo	1.00	1.00	21.80	0.002	0.002	0.002	3,631.76	79.17	21.38
As 4	37.00	18.00	110.00	Sobre	-1.00	-1.00	19.80	0.002	0.002	0.002	4,200.00	-83.16	-14.97
As 5	46.00	9.00	110.00	Sobre	-1.00	-1.00	19.80	0.003	0.002	0.002	4,200.00	-83.16	-7.48
As 6	55.00	0.00	110.00	Sobre	-1.00	-1.00	21.80	0.003	0.002	0.002	4,200.00	-91.56	0.00
As 7	64.00	9.00	110.00	Sobre	-1.00	1.00	19.80	0.003	0.002	0.002	4,200.00	-83.16	7.48
As 8	73.00	18.00	110.00	Sobre	-1.00	1.00	21.80	0.002	0.002	0.002	4,200.00	-91.56	16.48
As 9	82.00	27.00	110.00	Sobre	-1.00	1.00	19.80	0.002	0.002	0.002	3,631.76	-71.91	19.42
As 10	100.00	45.00	110.00	Sobre	-1.00	1.00	19.80	0.001	0.002	0.001	1,852.94	-36.69	16.51
Aportes Totales del Acero												-371.04	94.87

Cuadro Resumen			
C =			
	Concreto	Acero	Total
P (ton)	910.35	-371.04	539.31
M (ton m)	384.622875	94.87	479.49
Φ P (ton)			350.5528765
Φ M (ton m)			311.6709438

Carga y Momentos C=20 cm

Dato	Valor	Unidad
C	20	cm
a	17	cm
Area Comprimida	2550	cm2

Aporte del Concreto

Carga	P (ton)	M (ton m)
Valor	606.9	282.2085

Aporte del Acero

Material	di	Brazo de Palanca	b	Condicion	Signo P	Signo M	As	es o e's	ey	ε	fs	Aporte P (ton)	Aporte M (ton m)
As 1	10.00	45.00	110.00	Bajo	1.00	1.00	19.80	0.001	0.002	0.001	1,852.94	36.69	16.51
As 2	19.00	36.00	110.00	Bajo	1.00	1.00	19.80	0.001	0.002	0.001	2,742.35	54.30	19.55
As 3	28.00	27.00	110.00	Sobre	-1.00	-1.00	21.80	0.002	0.002	0.002	3,631.76	-79.17	-21.38
As 4	37.00	18.00	110.00	Sobre	-1.00	-1.00	19.80	0.002	0.002	0.002	4,200.00	-83.16	-14.97
As 5	46.00	9.00	110.00	Sobre	-1.00	-1.00	19.80	0.003	0.002	0.002	4,200.00	-83.16	-7.48
As 6	55.00	0.00	110.00	Sobre	-1.00	-1.00	21.80	0.003	0.002	0.002	4,200.00	-91.56	0.00
As 7	64.00	9.00	110.00	Sobre	-1.00	1.00	19.80	0.003	0.002	0.002	4,200.00	-83.16	7.48
As 8	73.00	18.00	110.00	Sobre	-1.00	1.00	21.80	0.002	0.002	0.002	4,200.00	-91.56	16.48
As 9	82.00	27.00	110.00	Sobre	-1.00	1.00	19.80	0.002	0.002	0.002	3,631.76	-71.91	19.42
As 10	100.00	45.00	110.00	Sobre	-1.00	1.00	19.80	0.001	0.002	0.001	1,852.94	-36.69	16.51
Aportes Totales del Acero												-529.38	52.12

Cuadro Resumen			
C =			
	Concreto	Acero	Total
P (ton)	606.9	-529.38	77.52
M (ton m)	282.2085	52.12	334.33
Φ P (ton)			50.38616471
Φ M (ton m)			217.3120629

Carga y Momentos C=1.21 cm

Dato	Valor	Unidad
C	1.21	cm
a	1.0285	cm
Area Comprimida	154.275	cm2

Aporte del Concreto

Carga	P (ton)	M (ton m)
Valor	36.71745	20.00577801

Aporte del Acero

Material	di	Brazo de Palanca	b	Condicion	Signo P	Signo M	As	es o e's	ey	ε	fs	Aporte P (ton)	Aporte M (ton m)
As 1	10.00	45.00	110.00	Sobre	-1.00	-1.00	19.80	0.001	0.002	0.001	1,852.94	-36.69	-16.51
As 2	19.00	36.00	110.00	Sobre	-1.00	-1.00	19.80	0.001	0.002	0.001	2,742.35	-54.30	-19.55
As 3	28.00	27.00	110.00	Sobre	-1.00	-1.00	21.80	0.002	0.002	0.002	3,631.76	-79.17	-21.38
As 4	37.00	18.00	110.00	Sobre	-1.00	-1.00	19.80	0.002	0.002	0.002	4,200.00	-83.16	-14.97
As 5	46.00	9.00	110.00	Sobre	-1.00	-1.00	19.80	0.003	0.002	0.002	4,200.00	-83.16	-7.48
As 6	55.00	0.00	110.00	Sobre	-1.00	-1.00	21.80	0.003	0.002	0.002	4,200.00	-91.56	0.00
As 7	64.00	9.00	110.00	Sobre	-1.00	1.00	19.80	0.003	0.002	0.002	4,200.00	-83.16	7.48
As 8	73.00	18.00	110.00	Sobre	-1.00	1.00	21.80	0.002	0.002	0.002	4,200.00	-91.56	16.48
As 9	82.00	27.00	110.00	Sobre	-1.00	1.00	19.80	0.002	0.002	0.002	3,631.76	-71.91	19.42
As 10	100.00	45.00	110.00	Sobre	-1.00	1.00	19.80	0.001	0.002	0.001	1,852.94	-36.69	16.51
Aportes Totales del Acero												-711.36	-20.00

Cuadro Resumen			
C =			
	Concreto	Acero	Total
P (ton)	36.71745	-711.36	-674.64
M (ton m)	20.00577801	-20.00	0.01
Φ P (ton)			-438.5153634
Φ M (ton m)			0.00593665

Cuadro: Flexión Viga Cabezal																									
Ubicación (m)	fc (kg/cm2)	As (cm2)	As' (cm2)	fy (kg/cm2)	h (cm)	d (cm)	df (cm)	b (cm)	M aplicado (ton m)	$\beta 1$	0.65< $\beta 1$ <0.85	ρ	ρB	ρmin	As min	a	Caso 4		C	C/d	Mn (Ton m)	Φ	$\Phi \times Mn$ (kg m)	Mu/ $\Phi \times Mn$	Cumple?
										$\rho = 0.85 \times \left(\frac{fc - 28}{fy} \right) \times 0.85$		$\rho = \frac{(As)}{(bw \times d)}$	$\rho B = \left(\frac{0.85 \times fc \times 6300 \times \beta 1}{(6300 + fy) \times fy} \right) + \rho T$	$\rho min = \frac{0.8 \times \sqrt{fc}}{fy}$	$As min = \rho min \times bw \times d$	$a = \frac{(A_s) f_y}{0.85 f_c b_w}$			$c = \frac{a}{\beta 1}$	$C/d = \frac{c}{d}$	$Mn = As \times fy \times (d - a/2) + As' \times fy \times \left(a - \frac{d}{2} \right)$	ASHTO	$\Phi \times Mn$		
0	280	11.47419465	4	4200	240	90	10	180	6.60	0.85	0.85	0.003187276	0.032087276	0.003187276	11.47419465	1.124921044	0.201014318	-0.019668258	1.3234	0.01470485	43.101	0.9	38.79	0.17	Si

Cortante Bastion (X)		
Dato	Valor	Unidad
b	180.00	cm
d	110.00	cm
f'c	280.00	kg/cm2
fy	4,200.00	kg/cm2
Pu	6,000.00	kg
Ag	19,800.00	cm2
Nu/(6*Ag)	0.05	
0.05*fc	14.00	
menor de	0.05	
s	30.00	cm
As min 1 =	2.63	cm2
As min 2 =	2.75	cm2
As min =	2.63	cm2
Vc limite	1,153.71	ton
Vc	663.63	ton
Vs =	32.40	ton
V =	696.03	ton
Φ	0.75	
ΦV_n	522.02	
V aplicado	99.40	ton
Vu/ ΦV_n	0.19	
Cumple		

Cortante Bastion (Y)		
Dato	Valor	Unidad
r	180.00	cm
d	110.00	cm
f'c	280.00	kg/cm2
fy	4,200.00	kg/cm2
Pu	6,000.00	kg
Ag	19,800.00	cm2
Nu/(6*Ag)	0.05	
0.05*fc	14.00	
menor de	0.60	
s	30.00	cm
As min 1 =	2.63	cm2
As min 2 =	2.75	cm2
As min =	2.63	cm2
Vc limite	1,153.71	ton
Vc	663.63	ton
Vs =	32.40	ton
V =	696.03	ton
Φ	0.75	
ΦV_n	522.02	
V aplicado	2.33	ton
Vu/ ΦV_n	0.004	
Cumple		